

# RL16GR-ICSA

## 4" 120V/20W GU10 Downlight

### Remodel, Insulated Ceiling, StopAire® Housing

#### Specifications/Features

##### Housing/Mounting

Remodel housing for use in hard and grid type ceilings.  
For use in applications with direct contact with insulation materials.  
White painted steel lamp housing and galvanized steel junction box and support arm.  
Retractable mounting clips lock fixture in place to allow easy installation into existing ceiling.

##### Megaman® Lamp (Optional)

Energy efficient, 6W or 7W PAR16 LED lamp  
Designed to last 25,000 hours  
Correlated Color Temperature of 2700K, 3000K, or 3500K, with Color Rendering Index of 82  
Correlated Color Temperature of 4000K, Color Rendering Index of 85

##### 6W PAR16 Lamp

Lumen output = 550 (92 Lumens per Watt)  
24° Beam spread with CBCP of 2100  
35° Beam spread with CBCP of 1240

##### 7W PAR16 Lamp

Lumen output = 530 (75.7 Lumens per Watt)  
35° Beam spread with Max.Luminous Intensity (cd) of 600  
Durable die-cast aluminum housing with lens to protect the LEDs and reflector  
RoHS compliant, contains no lead or mercury

##### Dimming (MEGAMAN® Lamps)

Dimmable to 10% with forward phase/TRIAC dimming.  
For optimal performance, use forward phase/TRIAC dimmer specifically designed for LED lamps.  
Dimming performance may vary due to field conditions, including but not limited to, power quality, installation and wiring, and variations in dimmer production.  
Please reference the dimmer manufacturer's instructions for dimmer installation and further information.  
For other manufacturer LED lamp compatibility, please consult factory.

##### Electrical

(1) 20W Max., 120V PAR16, GU10 base or MR16, GU10 base.  
Porcelain socket.  
J-box has (6) 1/2" pryouts and (4) sheathed cable pryouts. Spring latch access covers. Min. 75°C wire permitted.

##### Trims

Baffle, multiplier, adjustable, and decorative trim options available to suit a broad range of applications. See 4" Trims section of specification sheet for details

##### Warranty

This fixture is covered by ConTech's full one (1) year replacement guarantee after date of purchase. When used with Megaman® lamp option, a (3) year replacement guarantee after date of purchase is provided.

##### Labels/Usage

cCSAus Certified to UL Standards. Suitable for damp locations.  
Lamp is Energy Star Listed.  
Conforms to Washington State Energy Code (WSEC) for low air infiltration. Tested in accordance with ASTM E283 (2.0 CFM or less).



6W PAR16, 24°



6W PAR16, 35°



7W PAR16, 35°

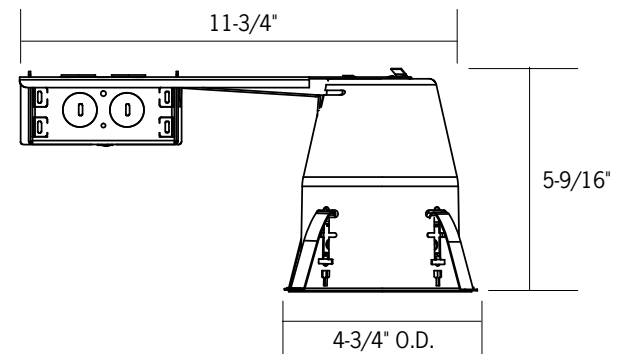
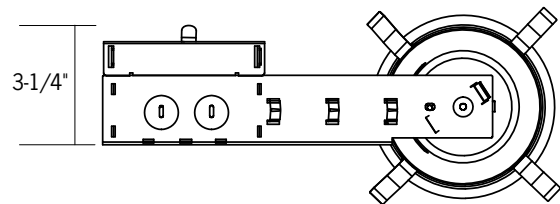

**Ceiling Opening:** 4-1/4"

**Ceiling Thickness:** 1/2" - 1-1/4"

# RL16GR-ICSA

4" 120V/20W GU10 Downlight  
Remodel, Insulated Ceiling, StopAire<sup>®</sup> Housing

## Ordering Information

---

Example Order:

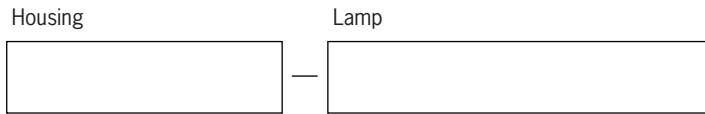

**RL16GR-ICSA**

- LEAVE BLANK** - NO LAMP
- ML06-2427K** - 6W, 24°, 2700K
- ML06-2430K** - 6W, 24°, 3000K
- ML06-2435K** - 6W, 24°, 3500K
- ML06-2440K** - 6W, 24°, 4000K
- ML06-3527K** - 6W, 35°, 2700K
- ML06-3530K** - 6W, 35°, 3000K
- ML06-3535K** - 6W, 35°, 3500K
- ML06-3540K** - 6W, 35°, 4000K
- ML05-3527K** - 7W, 35°, 2700K
- ML05-3530K** - 7W, 35°, 3000K
- ML05-3540K** - 7W, 35°, 4000K

## Trims for 4" RL16G Series Housings

- All trims have white trim ring finish unless specified.
- All trims are cCSAus Certified and suitable for damp locations; only shower trims are rated for wet locations.
- All trims compatible with Megaman® PAR16 lamps. For other manufacturer LED lamp compatibility, please consult factory.
- Clear lens provided with trim should only be used with open MR16 lamps. Lens should not be used with LED lamps.

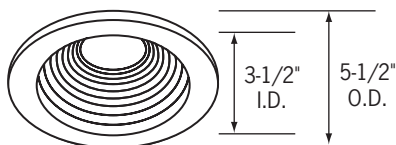

**CTR1601-B\***

Adjustable Black Baffle, Black Trim Ring

**CTR1601-P\***

Adjustable Black Baffle

**CTR1601-P-WHT\***

Adjustable White Baffle

Deep baffle traps stray light and conceals lamp. May be used as downlight or adjustable accent light with 60° swing adjustment.

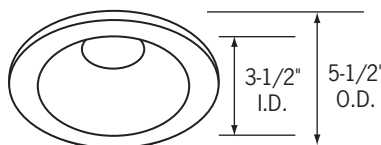

**CTR1602-P-(BLK, CLR, PL, WHT)\***

White Trim Ring, Select Reflector Finish

**CTR1602-B-BLK\***

Black Trim Ring, Black Reflector

**CTR1602-(ST, NK)-CLR\***

Select Metal Trim Finish, Clear Reflector

Multipliers utilizes a highly polished, specular reflector to maximize light intensity while concealing the light source. Offers the flexibility to be used as a downlight or adjustable accent light with 35° swing adjustment.

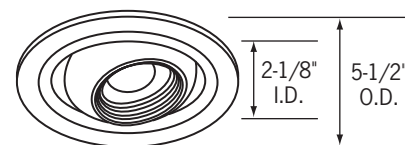

**CTR1608-P**

Black Baffled Eyeball

Up to 45° vertical aiming, 358° rotational adjustment. Black baffle provides excellent cutoff and lamp concealment. 45mm lens.

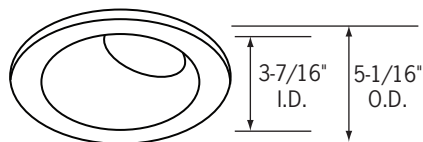

**CTR1614-P-CLR**

Clear Reflector Angled Wall Wash

Adjustable lampholder; 55-75° aiming angle. 45mm lens.

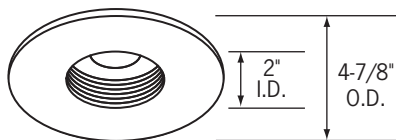

**CTR1605-P\***

Black Baffled Pin Spot

**CTR1605-P-WHT\***

White Baffled Pin Spot

Precise beam spread and unobtrusive appearance. Concealed lamp design for maximum eye comfort. Deep baffle.



**CTR1624G-(B, P)**

Fully Adjustable Square in Round, Select Finish

87° vertical and 359° rotation adjustment. Die-cast aluminum construction. Front access, spring latch lamp retainer ring. 47mm lens. Depth from ceiling: 2-1/2"

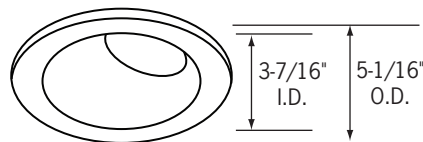

**CTR1614CL-P-CLR**

Angled Wall Wash Shower Trim

Die cast aluminum. Clear specular angled reflector. Adjustable lampholder; 55-75° aiming angle. Double neoprene gasketed. Clear glass lens. 45mm lens.

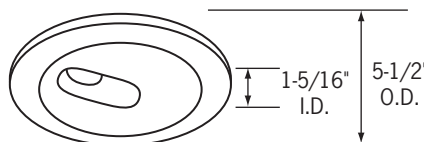

**CTR1603-P**

Slotted Wall Wash

Slot aperture permits maximum beam area adjustment for either wall wash or concealed accent lighting effects. 50° swing adjustment, 358° rotation. 50mm lens.

**CONTINUED**

All finishes are not available for all trims.

**Reflector Finish Options:**

- CLR** - Clear, Specular
- BLK** - Black, Specular
- WHT** - White Light, Specular
- PL** - Platinum, Matte

**Trim Finish Options:**

- P** - White
- B** - Black
- NK** - Nickel
- ST** - Brushed Stainless Steel

\*Trim uses stepped lens holder design and can hold up to two (2) light controlling elements. 45mm lens on lower level of lamp seat, 50mm lens on higher level.

## Trims for 4" RL16G Series Housings

- All trims have white trim ring finish unless specified.
- All trims are cCSAus Certified and suitable for damp locations; only shower trims are rated for wet locations.
- All trims compatible with Megaman® PAR16 lamps. For other manufacturer LED lamp compatibility, please consult factory.
- Clear lens provided with trim should only be used with open MR16 lamps. Lens should not be used with LED lamps.

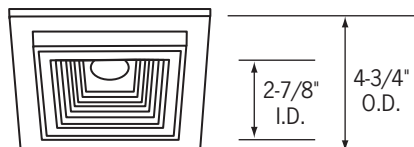

### CTR1604-P

Black Baffled Square

Deep baffle traps stray light and conceals light source. Downlight or adjustable: up to 35° vertical adjustment. 45mm lens.



### CTR1601SQ-B

Adjustable Black Baffle, Black Trim

### CTR1601SQ-P

Adjustable Black Baffle, White Trim

### CTR1601SQ-WHT

Adjustable White Baffle, White Trim

Deep baffle traps stray light and conceals lamp. May be used as downlight or adjustable accent light with 60° swing adjustment.

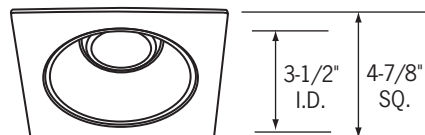

### CTR1602SQ-B-(BLK, CLR)

Adjustable Multiplier; Black Trim, Black or Clear Reflector

### CTR1602SQ-P-(CLR, WHT)

Adjustable Multiplier; White Trim, Clear or White Reflector

Multipliers utilizes a highly polished, specular reflector to maximize light intensity while concealing the light source. Offers the flexibility to be used as a downlight or adjustable accent light with 35° swing adjustment.

All finishes are not available for all trims.

#### Reflector Finish Options:

**CLR** - Clear, Specular  
**BLK** - Black, Specular  
**WHT** - White Light, Specular  
**PL** - Platinum, Matte

#### Trim Finish Options:

**P** - White  
**B** - Black  
**NK** - Nickel  
**ST** - Brushed Stainless Steel

\*Trim uses stepped lens holder design and can hold up to two (2) light controlling elements. 45mm lens on lower level of lamp seat, 50mm lens on higher level.