

CTL93 SERIES | Gallery M Track Luminaire with Adjustable Beam and Rigid Stem



High performance track luminaire delivering high outputs and offering field adjustable beam angles

- Clean aesthetics, simple cylinder form
- Seven (7) position adjustable beam optic
- Beam ranges from 13° to 41°
- Delivering up to 3,200 Lumens



Adjustable Beam

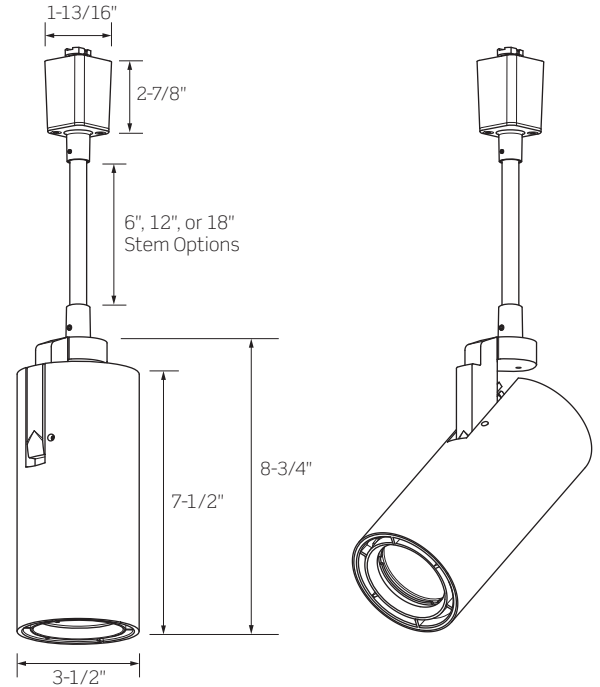

	VARIABLE SPOT	VARIABLE MEDIUM	VARIABLE FLOOD
BEAM ADJUSTMENT RANGE	13° to 41°	16° to 41°	23° to 41°
AVAILABLE SERIES / WATTAGE	MAX DELIVERED LUMENS		
CTL931 / 10W	972Lm	1000Lm	996Lm
CTL932 / 14W	1309Lm	1387Lm	1395Lm
CTL933 / 19W	N/A	1904Lm	1943Lm
CTL934 / 28W	N/A	2500Lm	2627Lm
CTL935 / 35W	N/A	N/A	3309Lm
COLOR TEMPERATURE	2700K / 3000K / 3500K / 4000K		
CRI	83 (80min) / 90+		
FINISHES	Matte Black / Matte White / Matte Silver		
DRIVER INPUT VOLTAGE	120V, 50/60Hz		
DIMMING TYPE	120V Forward/Reverse Phase Dimming		
COMPATIBILITY	CTL Units are compatible with ConTech Lighting LT/LT2 Single Circuit/Two Circuit and Luxbeam Track Systems, as well as Juno ^{®2} Lighting Trac-Master™ Systems		
LISTINGS	cCSAus Certified for use in the U.S. and Canada; Suitable for Dry Locations		
WARRANTY	Five (5) year replacement after date of purchase		
SYSTEM RATING	50,000 Hours @ 70% Lumen Maintenance		

1. Approximate lumen output based on 3000K performance; see photometric test results for additional information
2. Juno is a registered trademark of Juno Lighting

CTL93 SERIES | Gallery M Track Luminaire with Adjustable Beam and Rigid Stem

ORDERING INFORMATION

Example Order: CTL932RS12VS3KD-P

LED Series	Rigid Stem Length	Beam Option	CCT/CRI	Driver	Finish
CTL931 10W	RS6 6-Inches	VS³ Variable Spot: 13° to 41°	80+ CRI	D 120V Forward/Reverse Phase Dimming	B Matte Black
CTL932 14W	RS12 12-Inches	VM⁴ Variable Medium: 16° to 41°	27K 2700K	27KC 2700K	P Matte White
CTL933 19W	RS18 18-Inches	VF⁵ Variable Flood: 23° to 41°	3K 3000K	3KC 3000K	S Matte Silver
CTL934 28W			35K 3500K	35KC 3500K	
CTL935 35W			4K 4000K	4KC 4000K	

3. Variable Spot (VS) Beam is only available for Series 1 (10W) and Series 2 (14W)
 4. Variable Medium (VM) Beam is only available for Series 1 (10W) through Series 4 (28W)
 5. Variable Flood (VF) Beam is available for all LED Series

PRODUCT SPECIFICATIONS

PERFORMANCE SUMMARY

- Seven (7) position, field adjustable optic with three (3) different beam range options, the increments in the adjustments average 4-degrees per increment
- Engineered to provide superior glare control through the full range of beam spreads
- 2700K, 3000K, 3500K and 4000K CCTs; 80 CRI min., 83 typical; high CRI of 90+ available
- Excellent fixture-to-fixture color consistency with a 2-step MacAdam Ellipse tolerance
- 120V Forward or Reverse Dimming is standard for all wattage options. For dimmer compatibility and performance, refer to the Dimming Specifications below.

CONSTRUCTION

- A revolutionary track head with superior optics designed to bring theatre grade beam control to traditional gallery and commercial track heads
- Constructed of die-cast aluminum, the cylindrical body provides thermal management for the luminaire
- Locking mechanisms for Tilt (0° to 91°) and Rotation (365°)
- Integral ON/OFF switch and track polarity indicator are standard
- Fixture weight: 3 LBS

FIXTURE COMPATIBILITY

- Standard ConTech “CTL” track luminaires are cCSAus certified as-is for use with ConTech Lighting’s LT/LT2 Single Circuit/Two Circuit Track and Luxbeam Systems as well as Juno^{®1} Lighting Trac-Master™ Systems

DIMMING SPECIFICATIONS

- Incandescent 120V AC Dimmers adjust the light with *Forward Phase Control*, where the Dimmer “chops” the forward part of the AC Wave to deliver less or more power to the light source. No Neutral Wire Connection required.
- Electronic Low Voltage 120V AC Dimmers adjust the light with *Reverse Phase Control*, where the Dimmer “chops” the back part of the AC Wave to deliver less or more power to the light source. Neutral Wire Connection required.

FORWARD/REVERSE PHASE COMPATIBLE DIMMERS

MANUFACTURER	PRODUCT	MODEL	LIGHT OUTPUT
Leviton	Vizia	VPE06	4%-100%
Leviton	Decora	6673-10W	11%-100%
Lutron	Ariadni	TGCL-153P	0%-100%
Lutron	Diva	DVCL-153P	0%-100%
Lutron	Diva	DVELV303P	3%-100%
Lutron	Skylark	SELV300P	3%-100%
Lutron	Maestro	MAELV600	0%-100%
Lutron	Faetra	FAELV500	7%-100%
Lutron	Skylark C	SCL-153P	0%-100%
Lutron	Maestro C•L	MACL-153M	0%-99%
Lutron	RA2 Select	RRD-6CL	2%-98%

NOTES

1. If light is measured, then the dimming range is based on light output. If light is not measured, then the dimming range is based on the percentage of output current.
2. Testing was performed with a single fixture connected to dimmer.
3. Testing has been performed on these dimmers, but this does not imply any warranty of compatibility.
4. Dimming performance can be influenced by different loads, as well as variations in dimmer switches within the same model.
5. Dimmer maximum load rating with LED may differ from published traditional source dimmer ratings. Consult manufacturer for maximum dimmer information.
6. Consult factory for additional dimming information.

CTL93 SERIES | Gallery M Track Luminaire with Adjustable Beam: Photometry

CTL932VS3KD: 14W, 3000K, 83 CRI, VARIABLE SPOT MINIMUM

Test No. G25090401

Fixture Delivered Lumens: 1308.97
 Total Watts@120V: 14.7
 Lumens Per Watt: 89.05
 Center Beam Candle Power: 15158
 Beam Distribution: 13.05°
 Spacing Criterion: 0.24
 Color Rendering Index (CRI)¹: 82.8
 Color Temperature (CCT)²: 3004K
 Designed for 50,000 Hour Lamp Life³

Intensity Distribution		
DISTANCE (FT.)	FOOTCANDLES (FC)	BEAM DIA. (FT.)
4 FT	947.4	0.9
6 FT	421.1	1.4
8 FT	236.8	1.8
10 FT	151.6	2.3
12 FT	105.3	2.8
14 FT	77.3	3.2

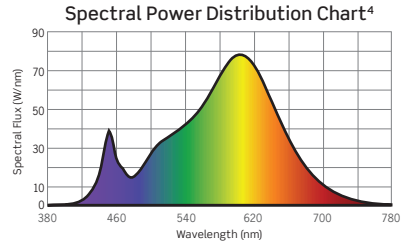
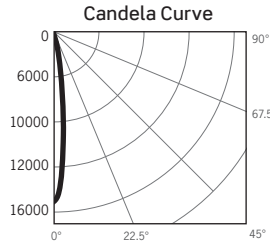

CTL932VS3KD: 14W, 3000K, 83 CRI, VARIABLE SPOT MAXIMUM

Test No. G25090402

Fixture Delivered Lumens: 1275.62
 Total Watts@120V: 28.7
 Lumens Per Watt: 86.78
 Center Beam Candle Power: 2625
 Beam Distribution: 41.93°
 Spacing Criterion: 0.64
 Color Rendering Index (CRI)¹: 82.8
 Color Temperature (CCT)²: 3004K
 Designed for 50,000 Hour Lamp Life³

Intensity Distribution		
DISTANCE (FT.)	FOOTCANDLES (FC)	BEAM DIA. (FT.)
4 FT	164.0	3.1
6 FT	72.9	4.6
8 FT	41.0	6.1
10 FT	26.2	7.7
12 FT	18.2	9.2
14 FT	13.4	10.7

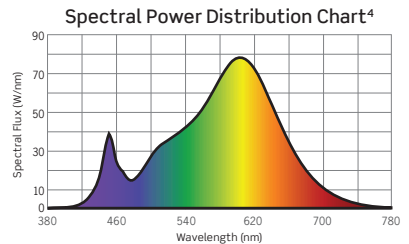
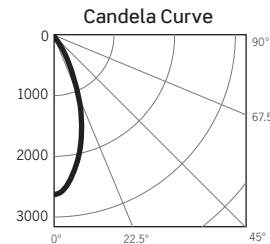

1. Accuracy of Rendering Colors 2. Color Appearance of Light Source 3. Dependent on Surrounding Temperatures 4. Colors Present within the Light Source

PHOTOMETRIC MULTIPLICATION FACTORS

Lumen output values fluctuate based on Color Temperature (CCT), Color Rendering Index (CRI), and Luminaire Wattage/Output. To estimate lumen output of the various options, multiply the 3000K standard CRI results by the following:

CCT MULTIPLIERS		
CCT	STANDARD CRI	HIGH (90+) CRI
2700K	0.98	0.81
3000K	1.00	0.85
3500K	1.01	0.86
4000K	1.02	0.89

VARIABLE SPOT OUTPUT MULTIPLIERS
10W
0.74

CTL93 SERIES | Gallery M Track Luminaire with Adjustable Beam: Photometry

CTL934VM3KD: 28W, 3000K, 83 CRI, VARIABLE MEDIUM MINIMUM

Test No. G25082601

Fixture Delivered Lumens: 2500.51
 Total Watts@120V: 28.6
 Lumens Per Watt: 87.13
 Center Beam Candle Power: 17753
 Beam Distribution: 16.02°
 Spacing Criterion: 0.32
 Color Rendering Index (CRI)¹: 82.8
 Color Temperature (CCT)²: 3004K
 Designed for 50,000 Hour Lamp Life³

Intensity Distribution

DISTANCE (FT.)	FOOTCANDLES (FC)	BEAM DIA. (FT.)
4 FT	1109.5	1.1
6 FT	493.1	1.7
8 FT	277.4	2.3
10 FT	177.5	2.8
12 FT	123.3	3.4
14 FT	90.6	3.9

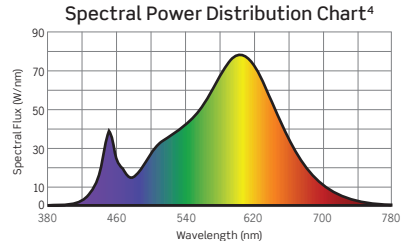
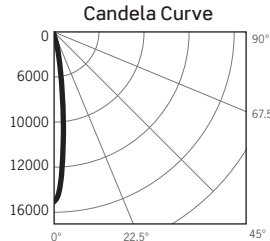

CTL934VM3KD: 28W, 3000K, 83 CRI, VARIABLE MEDIUM MAXIMUM

Test No. G25082602

Fixture Delivered Lumens: 2442.74
 Total Watts@120V: 28.7
 Lumens Per Watt: 85.11
 Center Beam Candle Power: 4688
 Beam Distribution: 41.36°
 Spacing Criterion: 0.65
 Color Rendering Index (CRI)¹: 82.8
 Color Temperature (CCT)²: 3004K
 Designed for 50,000 Hour Lamp Life³

Intensity Distribution

DISTANCE (FT.)	FOOTCANDLES (FC)	BEAM DIA. (FT.)
4 FT	293.0	3.0
6 FT	130.2	4.5
8 FT	73.2	6.0
10 FT	46.9	7.6
12 FT	32.6	9.1
14 FT	23.9	10.6

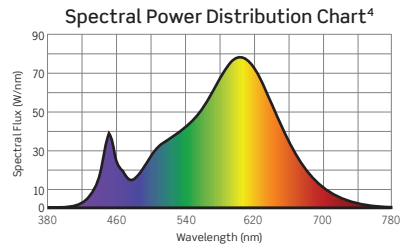
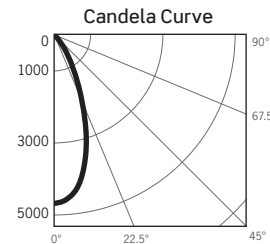

1. Accuracy of Rendering Colors 2. Color Appearance of Light Source 3. Dependent on Surrounding Temperatures 4. Colors Present within the Light Source

PHOTOMETRIC MULTIPLICATION FACTORS

Lumen output values fluctuate based on Color Temperature (CCT), Color Rendering Index (CRI), and Luminaire Wattage/Output. To estimate lumen output of the various options, multiply the 3000K standard CRI results by the following:

CCT MULTIPLIERS

CCT	STANDARD CRI	HIGH (90+) CRI
2700K	0.98	0.81
3000K	1.00	0.85
3500K	1.01	0.86
4000K	1.02	0.89

VARIABLE MEDIUM OUTPUT MULTIPLIERS

10W	14W	19W
0.30	0.42	0.59

CTL93 SERIES | Gallery M Track Luminaire with Adjustable Beam: Photometry

CTL935VF3KD: 35W, 3000K, 83 CRI, VARIABLE FLOOD MINIMUM

Test No. G25081302

Fixture Delivered Lumens: 3309.39
 Total Watts@120V: 35.4
 Lumens Per Watt: 93.49
 Center Beam Candle Power: 15479
 Beam Distribution: 23.07°
 Spacing Criterion: 0.40
 Color Rendering Index (CRI)¹: 82.8
 Color Temperature (CCT)²: 3004K
 Designed for 50,000 Hour Lamp Life³

DISTANCE (FT.)	FOOTCANDLES (FC)	BEAM DIA. (FT.)
4 FT	967.4	1.6
6 FT	430.0	2.5
8 FT	241.9	3.3
10 FT	154.8	4.1
12 FT	107.5	4.9
14 FT	79.0	5.7

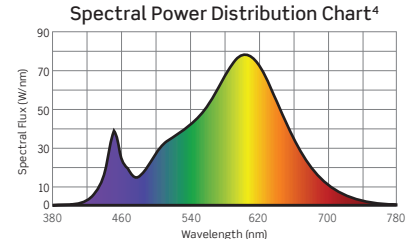
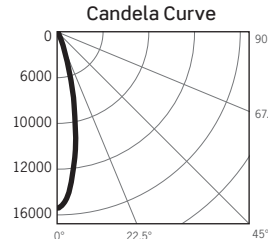

CTL935VF3KD: 35W, 3000K, 83 CRI, VARIABLE FLOOD MAXIMUM

Test No. G25081303

Fixture Delivered Lumens: 3209.70
 Total Watts@120V: 35.4
 Lumens Per Watt: 90.70
 Center Beam Candle Power: 5866
 Beam Distribution: 41.05°
 Spacing Criterion: 0.66
 Color Rendering Index (CRI)¹: 82.8
 Color Temperature (CCT)²: 3004K
 Designed for 50,000 Hour Lamp Life³

DISTANCE (FT.)	FOOTCANDLES (FC)	BEAM DIA. (FT.)
4 FT	366.6	3.0
6 FT	162.9	4.5
8 FT	91.7	6.0
10 FT	58.7	7.5
12 FT	40.7	9.0
14 FT	29.9	12.0

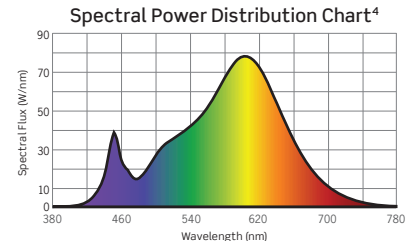
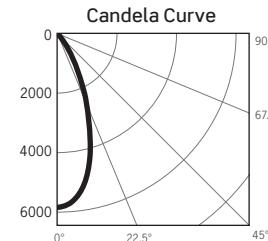

1. Accuracy of Rendering Colors 2. Color Appearance of Light Source 3. Dependent on Surrounding Temperatures 4. Colors Present within the Light Source

PHOTOMETRIC MULTIPLICATION FACTORS

Lumen output values fluctuate based on Color Temperature (CCT), Color Rendering Index (CRI), and Luminaire Wattage/Output. To estimate lumen output of the various options, multiply the 3000K standard CRI results by the following:

CCT	STANDARD CRI	HIGH (90+) CRI
2700K	0.98	0.81
3000K	1.00	0.85
3500K	1.01	0.86
4000K	1.02	0.89

10W	14W	19W	28W
0.30	0.42	0.59	0.79

CTL93 SERIES | Gallery M Track Luminaire with Adjustable Beam: Photometry

TM-30 DATA: CTL935MF3KD

ANSI/IES TM-30-18 Color Rendition Report Test No. S21072001

Colors are for visual orientation purposes only

R_f	86
R_g	95
CCT(K)	3004K
D_{uv}	0.0007
u^l	0.2502
v^l	0.5222

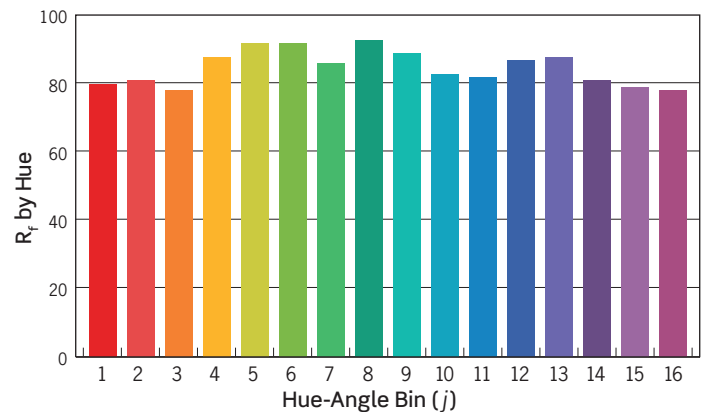
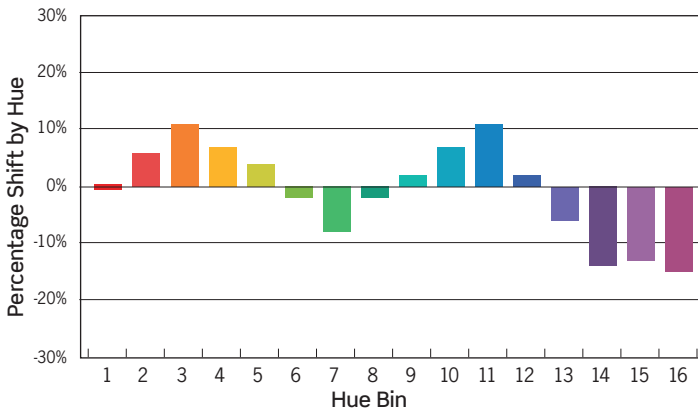
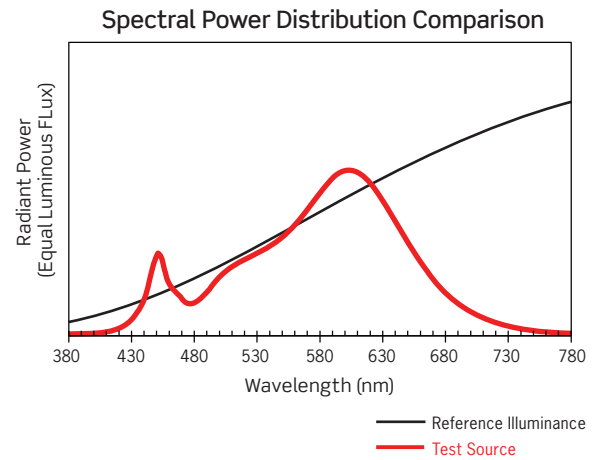
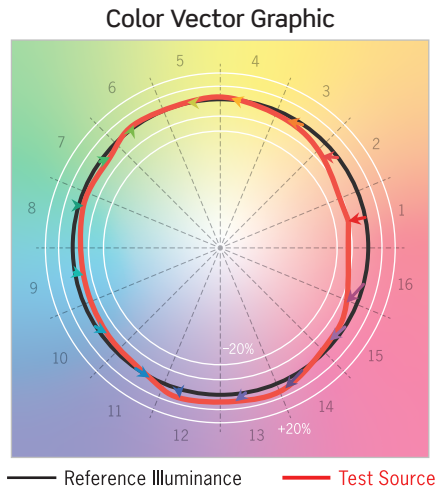

HUE BIN	1	2	3	4	5	6	7	8	9	10	11	12	13	14	15	16
HUE SHIFT	0%	7%	10%	6%	3%	-2%	-6%	-1%	3%	8%	11%	2%	-8%	-16%	-13%	-14%
R_f VALUE	80	82	80	91	94	94	88	94	90	86	84	87	88	80	79	78