

CTL93 SERIES | Gallery M Track Luminaire with Rigid Stem featuring Xicato® LED

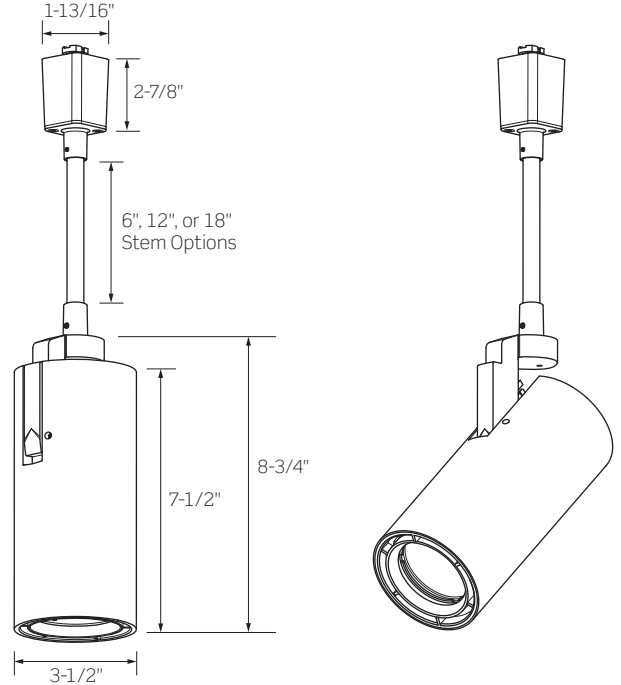

High performance track luminaire delivering high outputs and superior beam control

- Clean aesthetics, simple cylinder form
- Multiple beam distributions
- Delivering up to 2400 Lumens
- Xicato 95CRI Series COB



	CTL931	CTL932	CTL933	CTL934	CTL935
WATTAGE	10W	14W	19W	28W	35W
LUMEN OUTPUT ¹ BY BEAM SPREAD					
Narrow Spot (12°)	723Lm	990Lm	1324Lm	N/A	N/A
Spot (15°)	661Lm	920Lm	1276Lm	1716Lm	2131Lm
Medium Flood (35°)	745Lm	1038Lm	1439Lm	1935Lm	2403Lm
Flood (52°)	744Lm	1036Lm	1437Lm	1931Lm	2399Lm
Wide Flood (79°)	691Lm	963Lm	1335Lm	1794Lm	2229Lm
COLOR TEMPERATURE	2700K / 3000K / 3500K / 4000K				
CRI	95				
FINISHES	Matte Black / Matte White / Matte Silver				
DRIVER INPUT VOLTAGE	120V, 50/60Hz				
DIMMING TYPE	120V Forward/Reverse Phase Dimming				
COMPATIBILITY	CTL Units are compatible with ConTech Lighting LT/LT2 Single Circuit/Two Circuit and Luxbeam Track Systems, as well as Juno ^{®2} Lighting Trac-Master™ Systems				
LISTINGS	cCSAus Certified for use in the U.S. and Canada; Suitable for Dry Locations				
WARRANTY	Five (5) year replacement after date of purchase				
SYSTEM RATING	50,000 Hours @ 70% Lumen Maintenance				

1. Approximate lumen output based on 3000K performance; see photometric test results for additional information
 2. Juno is a registered trademark of Juno Lighting

CTL93 SERIES | Gallery M Track Luminaire with Rigid Stem featuring Xicato® LED

ORDERING INFORMATION

Example Order: CTL932RS6MF3XCD-P

LED Series	Rigid Stem Length ³	Beam Option	CCT/CRI	Driver	Finish
CTL931 10W	RS6 6-Inches	NS² Narrow Spot: 13° Beam / 26° Field	95 CRI	D 120V Forward/Reverse Phase Dimming	B Matte Black
CTL932 14W	RS12 12-Inches	SP Spot: 18° Beam / 42° Field	27XC 2700K		P Matte White
CTL933 19W	RS18 18-Inches	MF Medium Flood: 35° Beam / 57° Field	3XC 3000K		S Matte Silver
CTL934 28W		FL Flood: 51° Beam / 64° Field	35XC 3500K		
CTL935 35W		WF Wide Flood: 80° Beam / 102° Field	4XC 4000K		

2. Narrow Spot (NS) Beam is only available for Series 1 (10W) through Series 3 (19W)

ACCESSORY & REPLACEMENT OPTIC ORDERING INFORMATION

Each Gallery M Luminaire may hold up to two (2) pieces of Media **OR** one (1) Snoot or Barn Door Assembly plus one (1) piece of Media



Snoot
with *Optional Cross Blades*
Exterior painted per finish selection: Black (B), White (P) or Silver (S). Interior and Cross Blades are always Black.

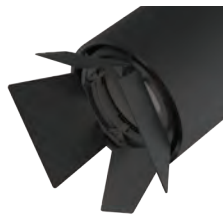

Barn Doors
Black finish. Barn Doors may hold one LF18 Lens or LA-35 Honeycomb Louver.



Honeycomb Louver
Black finish

Accessory
FA-93 Snoot with optional Cross Blades

Finish
B Matte Black
P Matte White
S Matte Silver

Accessory
BD93 Barn Doors

Finish
B Matte Black

Accessory
FA-16-60MM 2-3/8-In. Black Honeycomb Louver
LA-35 3-1/16-In. Black Honeycomb Louver for use within Barn Doors only



Tempered Glass Filters and Lenses
1/8-Inch Thick, typ.

Accessory
LF16 Tempered Glass Filters and Lenses
LF18 Tempered Glass Filters and Lenses for use within Barn Doors only

Finish	
C Clear	A Amber
SL Soft Light	B Blue
SOL Solite	LB Light Blue
LS Linear Spread	G Green
73 Spread	R Red
UV Optivex UV	RO Rose
	Y Yellow

Size
60MM 2-3/8-Inch
<i>Leave Blank</i>
3-1/16-Inch LF18 Series for use within Barn Doors only

Replacement Optics
CTL93XOPT-NS³ Narrow Spot Replacement
CTL93XOPT-SP Spot Replacement
CTL93XOPT-MF Medium Flood Replacement
CTL93XOPT-FL Flood Replacement
CTL93XOPT-WF Wide Flood Replacement

3. Narrow Spot (CTL93OPT-NS) Optic is only for use on luminaires **originally ordered** with the NS Optic

CTL93 SERIES | Gallery M Track Luminaire with Rigid Stem featuring Xicato® LED

PRODUCT SPECIFICATIONS

PERFORMANCE SUMMARY

- The Xicato 95 CRI Series COBs are designed to perfectly emulate natural light sources, with precise color rendering by CIE or IES standards, for the most exacting illumination of art, architecture, or other surfaces
- 2700K, 3000K, 3500K and 4000K Color temperatures, all with 95 CRI
- Xicato Modules feature extraordinary color consistency within 1x2-step MacAdam ellipse
- Precise beam control ensures that even at lower aiming angles the luminaire is glare free and quiet in the ceiling
- Full collection of accessories available to produce a myriad of filtering and framing effects
- 120V Forward or Reverse Dimming is standard for all wattage options. For dimmer compatibility and performance, refer to the Dimming Specifications below.
- Five (5) Beam Distributions available: 13° Narrow Spot, 18° Spot, 35° Medium Flood, 51° Flood, and 80° Wide Flood
- Optics are field interchangeable (with restrictions) and provide smooth, striation-free beams
- Luminaire may accept up to two (2) pieces of media (Lens or Louver), one (1) Snoot/Barn Door Assembly plus one (1) piece of media (Lens or Louver). Consult ordering information for proper combinations and sizes. **NOTE: Luminaire** may hold one (1) LF16 60MM Series Lens or FA-16-60MM Louver; **Barn Doors** may hold one LF18 Series Lens or LA-35 Louver
- Integral ON/OFF switch and track polarity indicator are standard
- Fixture weight: 3 LBS

CONSTRUCTION

- A revolutionary track head with superior optics designed to bring theatre grade beam control to traditional gallery and commercial track heads
- Constructed of die-cast aluminum, the cylindrical body provides thermal management for the luminaire
- Locking mechanisms for Tilt (0° to 91°) and Rotation (365°)

FIXTURE COMPATIBILITY

- Standard ConTech “CTL” track luminaires are cCSAus certified as-is for use with ConTech Lighting’s LT/LT2 Single Circuit/Two Circuit Track and Luxbeam Systems as well as Juno®1 Lighting Trac-Master™ Systems

DIMMING SPECIFICATIONS

- Incandescent 120V AC Dimmers adjust the light with *Forward Phase Control*, where the Dimmer “chops” the forward part of the AC Wave to deliver less or more power to the light source. No Neutral Wire Connection required.
- Electronic Low Voltage 120V AC Dimmers adjust the light with *Reverse Phase Control*, where the Dimmer “chops” the back part of the AC Wave to deliver less or more power to the light source. Neutral Wire Connection required.

FORWARD/REVERSE PHASE COMPATIBLE DIMMERS

MANUFACTURER	PRODUCT	MODEL	LIGHT OUTPUT
Leviton	Vizia	VPE06	4%-100%
Leviton	Decora	6673-10W	11%-100%
Lutron	Ariadni	TGCL-153P	0%-100%
Lutron	Diva	DVCL-153P	0%-100%
Lutron	Diva	DVELV303P	3%-100%
Lutron	Skylark	SELV300P	3%-100%
Lutron	Maestro	MAELV600	0%-100%
Lutron	Faetra	FAELV500	7%-100%
Lutron	Skylark C	SCL-153P	0%-100%
Lutron	Maestro C•L	MAEL-153M	0%-99%
Lutron	RA2 Select	RRD-6CL	2%-98%

NOTES

1. If light is measured, then the dimming range is based on light output. If light is not measured, then the dimming range is based on the percentage of output current.
2. Testing was performed with a single fixture connected to dimmer.
3. Testing has been performed on these dimmers, but this does not imply any warranty of compatibility.
4. Dimming performance can be influenced by different loads, as well as variations in dimmer switches within the same model.
5. Dimmer maximum load rating with LED may differ from published traditional source dimmer ratings. Consult manufacturer for maximum dimmer information.
6. Consult factory for additional dimming information.

CTL93 SERIES | Gallery M Track Luminaire Xicato® LED Photometry

CTL93NS3XCD: 19W, 3000K, 95 CRI, NARROW SPOT BEAM

Test No. G25090403

Fixture Delivered Lumens: 1324.29
 Total Watts@120V: 20.3
 Lumens Per Watt: 64.24
 Center Beam Candle Power: 16112
 Beam Distribution: 12.8°
 Spacing Criterion: 0.24
 Color Rendering Index (CRI)¹: 97.8
 Color Temperature (CCT)²: 2938K
 Designed for 50,000 Hour Lamp Life³

Intensity Distribution

DISTANCE (FT.)	FOOTCANDLES (FC)	BEAM DIA. (FT.)
4 FT	1007.0	0.9
6 FT	447.6	1.4
8 FT	251.8	1.8
10 FT	161.1	2.3
12 FT	111.9	2.7
14 FT	82.2	3.2

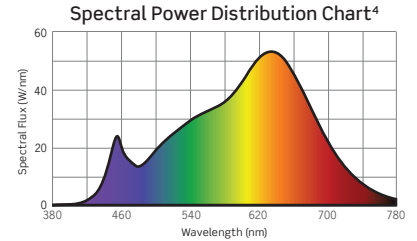
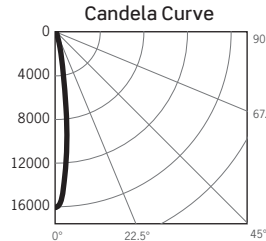

NARROW SPOT BEAM OUTPUT MULTIPLIERS

10W	14W
0.55	0.75

CTL935SP3XCD: 35W, 3000K, 95 CRI, SPOT BEAM

Test No. G25082701

Fixture Delivered Lumens: 2131.04
 Total Watts@120V: 34.7
 Lumens Per Watt: 61.41
 Center Beam Candle Power: 11703
 Beam Distribution: 18.2°
 Spacing Criterion: 0.36
 Color Rendering Index (CRI)¹: 97.8
 Color Temperature (CCT)²: 2938K
 Designed for 50,000 Hour Lamp Life³

Intensity Distribution

DISTANCE (FT.)	FOOTCANDLES (FC)	BEAM DIA. (FT.)
4 FT	731.5	1.3
6 FT	325.1	1.9
8 FT	182.9	2.6
10 FT	117.0	3.2
12 FT	81.3	3.9
14 FT	59.7	4.5

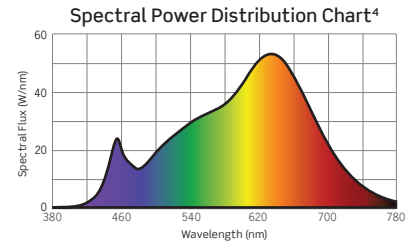
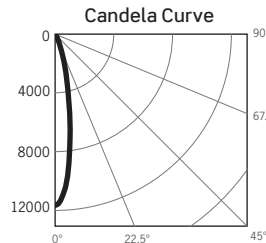

CTL935MF3XCD: 35W, 3000K, 95 CRI, MEDIUM FLOOD BEAM

Test No. G25082605

Fixture Delivered Lumens: 2403.31
 Total Watts@120V: 34.7
 Lumens Per Watt: 69.26
 Center Beam Candle Power: 6507
 Beam Distribution: 35.5°
 Spacing Criterion: 0.55
 Color Rendering Index (CRI)¹: 97.8
 Color Temperature (CCT)²: 2938K
 Designed for 50,000 Hour Lamp Life³

Intensity Distribution

DISTANCE (FT.)	FOOTCANDLES (FC)	BEAM DIA. (FT.)
4 FT	406.7	2.6
6 FT	180.7	3.8
8 FT	101.7	5.1
10 FT	65.1	6.4
12 FT	45.2	7.7
14 FT	33.2	9.0

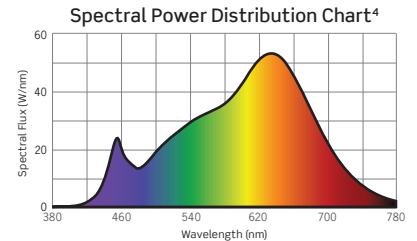
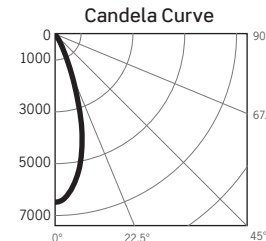

OUTPUT MULTIPLIERS

10W	14W	19W	28W
0.31	0.43	0.60	0.81

1. Accuracy of Rendering Colors 2. Color Appearance of Light Source 3. Dependent on Surrounding Temperatures 4. Colors Present within the Light Source

PHOTOMETRIC MULTIPLICATION FACTORS

Lumen output values fluctuate based on Color Temperature (CCT), Color Rendering Index (CRI), and Luminaire Wattage/Output. To estimate lumen output of the various options, multiply the 3000K standard CRI results by the following:

CCT MULTIPLIERS

CCT	95 CRI
2700K	0.92
3000K	1.00
3500K	1.05
4000K	1.10

CTL93 SERIES | Gallery M Track Luminaire Xicato® LED Photometry

CTL935FL3XCD: 35W, 3000K, 95 CRI, FLOOD BEAM

Test No. G25082604

Fixture Delivered Lumens: 2398.7
 Total Watts@120V: 34.8
 Lumens Per Watt: 68.93
 Center Beam Candle Power: 3637
 Beam Distribution: 51.1°
 Spacing Criterion: 0.72
 Color Rendering Index (CRI): 97.8
 Color Temperature (CCT): 2938K
 Designed for 50,000 Hour Lamp Life³

Intensity Distribution		
DISTANCE (FT.)	FOOTCANDLES (FC)	BEAM DIA. (FT.)
4 FT	227.3	3.8
6 FT	101.0	5.7
8 FT	56.8	7.6
10 FT	36.4	9.6
12 FT	25.3	11.5
14 FT	18.6	13.4

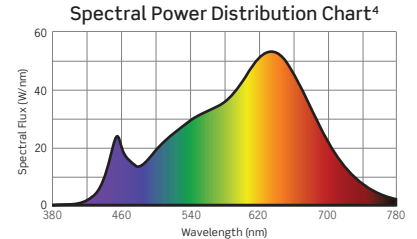
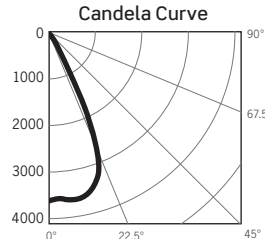

CTL935WF3XCD: 35W, 3000K, 95 CRI, WIDE FLOOD BEAM

Test No. G25091501

Fixture Delivered Lumens: 2228.46
 Total Watts@120V: 34.4
 Lumens Per Watt: 64.78
 Center Beam Candle Power: 1566
 Beam Distribution: 79.9°
 Spacing Criterion: 1.13
 Color Rendering Index (CRI): 97.8
 Color Temperature (CCT): 2938K
 Designed for 50,000 Hour Lamp Life³

Intensity Distribution		
DISTANCE (FT.)	FOOTCANDLES (FC)	BEAM DIA. (FT.)
4 FT	97.9	6.7
6 FT	43.5	10.1
8 FT	24.5	13.4
10 FT	15.7	16.8
12 FT	10.9	20.1
14 FT	8.0	23.5

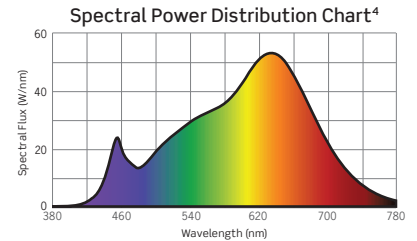
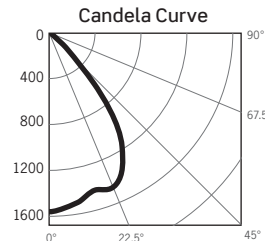

1. Accuracy of Rendering Colors 2. Color Appearance of Light Source 3. Dependent on Surrounding Temperatures 4. Colors Present within the Light Source

PHOTOMETRIC MULTIPLICATION FACTORS

Lumen output values fluctuate based on Color Temperature (CCT), Color Rendering Index (CRI), and Luminaire Wattage/Output. To estimate lumen output of the various options, multiply the 3000K standard CRI results by the following:

CCT MULTIPLIERS	
CCT	95 CRI
2700K	0.92
3000K	1.00
3500K	1.05
4000K	1.10

OUTPUT MULTIPLIERS			
10W	14W	19W	28W
0.31	0.43	0.60	0.81

CTL93 SERIES | Gallery M Track Luminaire Xicato® LED Photometry

TM-30 DATA: CTL935MF3XCD

ANSI/IES TM-30-18 Color Rendition Report Test No. S25082701

Colors are for visual orientation purposes only

R_f	95
R_g	101
CCT(K)	2938K
D_{uv}	-0.0025
u^l	0.2536
v^l	0.5192

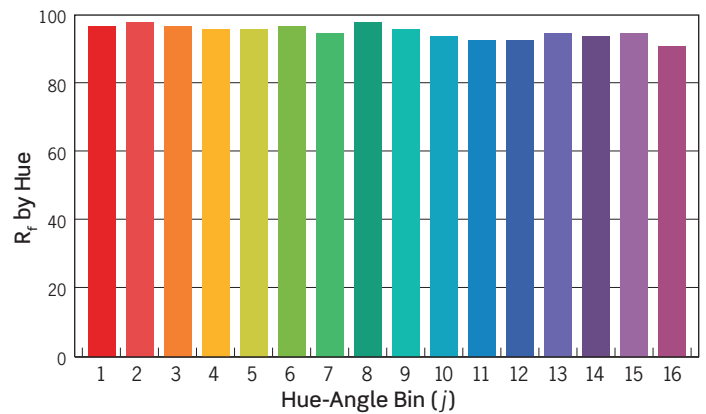
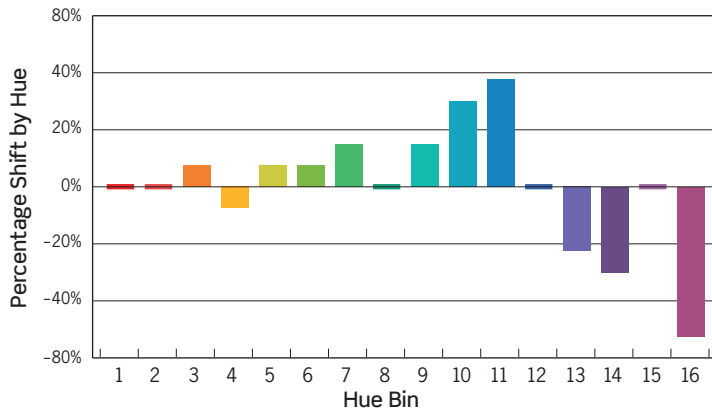
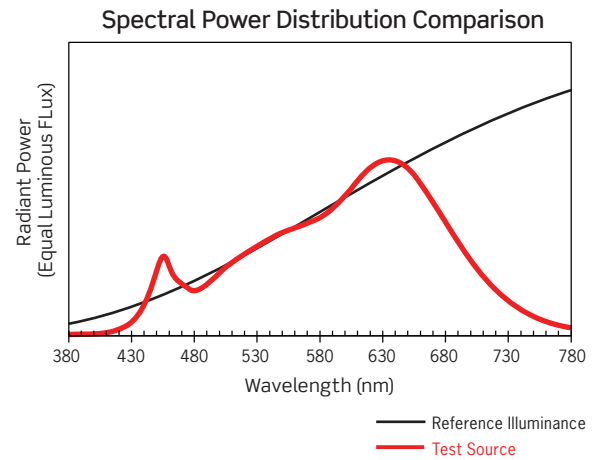
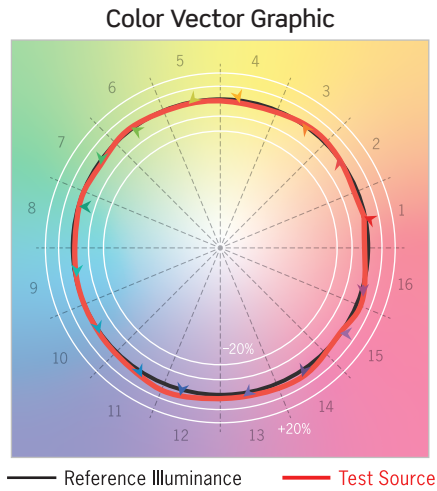

HUE BIN	1	2	3	4	5	6	7	8	9	10	11	12	13	14	15	16
HUE SHIFT	0%	0%	1%	-1%	1%	1%	2%	0%	2%	4%	5%	0%	-3%	-4%	0%	-7%
R_f VALUE	97	98	97	96	96	97	95	98	96	94	93	93	95	94	95	91