

CTL93C SERIES | Gallery M Canopy Mount Luminaire

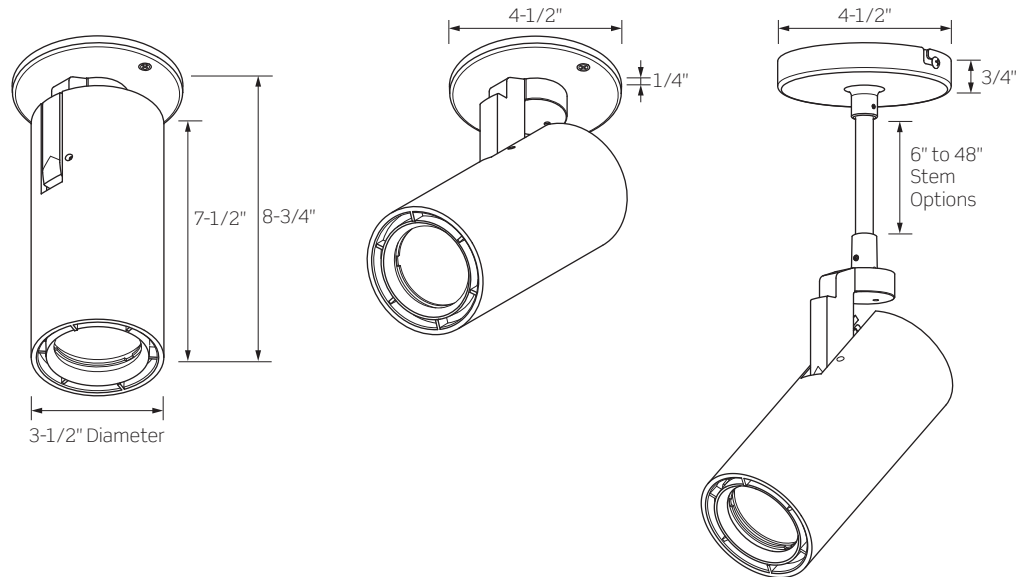

High performance track luminaire delivering high outputs and superior beam control

- Clean aesthetics, simple cylinder form
- Delivering up to 3,700 Lumens
- Multiple beam distributions
- Consistent color rendering



	CTL931C	CTL932C	CTL933C	CTL934C	CTL935C
WATTAGE	10W	14W	19W	28W	35W
LUMEN OUTPUT ¹ BY BEAM SPREAD					
Narrow Spot (12°)	1058 Lm	1424 Lm	N/A	N/A	N/A
Spot (15°)	1110 Lm	1536 Lm	2108 Lm	2768 Lm	N/A
Narrow Flood (22°)	981 lm	1374 Lm	1914 Lm	2587 lm	3260 Lm
Medium Flood (35°)	1118 Lm	1566 Lm	2182 Lm	2949 Lm	3716 Lm
Flood (52°)	1124 Lm	1574 Lm	2193 lm	2964 Lm	3735 Lm
Wide Flood (79°)	1046 Lm	1464 Lm	2040 Lm	2758 Lm	3475 Lm
COLOR TEMPERATURE	2700K / 3000K / 3500K / 4000K				
CRI	83 (80min) / 90+				
FINISHES	Matte Black / Matte White / Matte Silver				
DRIVER INPUT VOLTAGE	120V/277V, 50/60Hz				
DIMMING TYPE	120V Forward/Reverse Phase or 120V/277V 0-10V Dimming				
MOUNTING	Canopy option for ceiling or wall mount. Rigid Stem option for ceiling mount only.				
LISTINGS	cCSAus Certified for use in the U.S. and Canada; Suitable for Dry Locations				
WARRANTY	Five (5) year replacement after date of purchase				
SYSTEM RATING	50,000 Hours @ 70% Lumen Maintenance				

1. Approximate lumen output based on 3000K performance; see photometric test results for additional information

CTL93C SERIES | Gallery M Canopy Mount Luminaire

ORDERING INFORMATION

Example Order: CTL932CRSSP3KD-P

LED Series	Mounting Options	Beam Option	CCT/CRI	Driver	Finish	Alternate Stems	Finish
CTL931 10W CTL932 14W CTL933 19W CTL934 28W CTL935 35W	C Mono-Point Canopy CRS² Mono-Point Canopy with 6" Rigid Stem	NS³ Narrow Spot: 12° Beam / 21° Field SP⁴ Spot: 15° Beam / 31° Field NF Narrow Flood: 22° Beam / 45° Field MF Medium Flood: 35° Beam / 56° Field FL Flood: 52° Beam / 62° Field WF Wide Flood: 79° Beam / 101° Field	80+ CRI 27K 2700K 3K 3000K 35K 3500K 4K 4000K 90+ CRI 27KC 2700K 3KC 3000K 35KC 3500K 4KC 4000K	MVD 120V Forward/Reverse Phase Dimming OR 120V/277V 0-10V Dimming	B Matte Black P Matte White S Matte Silver	12-STEM-A 12-In. 18-STEM-A 18-In. 24-STEM-A 24-In. 30-STEM-A 30-In. 36-STEM-A 36-In. 48-STEM-A 48-In.	B Matte Black P Matte White S Matte Silver

- 2. CRS Option includes 6-inch Rigid Stem and field cuttable wiring for Stem lengths up to 48-inches
- 3. Narrow Spot (NS) Beam is only available for Series 1 (10W) and Series 2 (14W)
- 4. Spot (SP) Beam is only available for Series 1 (10W) through Series 4 (28W)

ACCESSORY & REPLACEMENT OPTIC ORDERING INFORMATION

Each Gallery M Luminaire may hold up to two (2) pieces of Media **OR** one (1) Snoot or Barn Door Assembly plus one (1) piece of Media

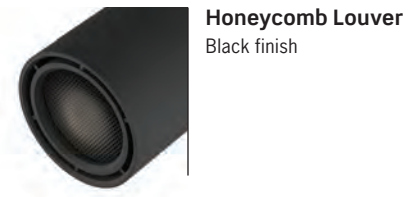
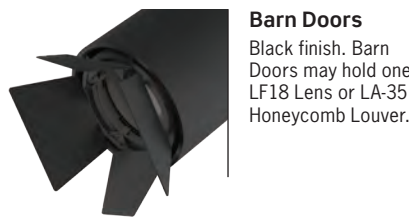

Accessory	Finish
FA-93 Snoot with optional Cross Blades	B Matte Black P Matte White S Matte Silver

Accessory	Finish
BD93 Barn Doors	B Matte Black

Accessory	Finish
FA-16-60MM 2-3/8-In. Black Honeycomb Louver LA-35 3-1/16-In. Black Honeycomb Louver for use within Barn Doors only	

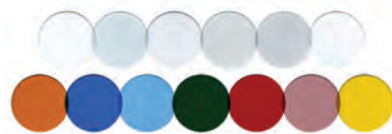

Tempered Glass Filters and Lenses
1/8-Inch Thick, typ.

Accessory
LF16 Tempered Glass Filters and Lenses LF18 Tempered Glass Filters and Lenses for use within Barn Doors only

Finish
C Clear A Amber SL Soft Light B Blue SOL Solite LB Light Blue LS Linear Spread G Green 73 Spread R Red UV Optivex UV RO Rose Y Yellow

Size
60MM 2-3/8-Inch Leave Blank 3-1/16-Inch LF18 Series for use within Barn Doors only

Replacement Optics
CTL930PT-NS⁴ Narrow Spot Replacement CTL930PT-SP⁵ Spot Replacement CTL930PT-NF Narrow Flood Replacement CTL930PT-MF Medium Flood Replacement CTL930PT-FL Flood Replacement CTL930PT-WF Wide Flood Replacement

- 4. Narrow Spot (CTL930PT-NS) Optic is only for use on luminaires originally ordered with NS Optic
- 5. Spot (CTL930PT-SP) Optic is only for use on luminaires originally ordered with SP Optic

CTL93C SERIES | Gallery M Canopy Mount Luminaire

PRODUCT SPECIFICATIONS

PERFORMANCE SUMMARY

- 2700K, 3000K, 3500K and 4000K CCTs; 80 CRI min., 83 typical; high CRI of 90+ available
- Excellent fixture-to-fixture color consistency with a 2-step MacAdam Ellipse tolerance
- Precise beam control ensures that even at lower aiming angles the luminaire is glare free and quiet in the ceiling
- Full collection of accessories available to produce a myriad of filtering and framing effects
- Dimming is standard for all wattage options using compatible 120V Forward or Reverse OR 120V/277V 0-10V Dimming systems. For dimmer compatibility and performance, refer to the Dimming Specifications below.

CONSTRUCTION

- A revolutionary track head with superior optics designed to bring theatre grade beam control to traditional gallery and commercial track heads
- Constructed of die-cast aluminum, the cylindrical body provides thermal management for the luminaire
- Mono-Point Canopy Housing is constructed of cast aluminum, may be ceiling or wall mounted

- Mono-Point Canopy Housing with Rigid Stem is constructed of cast aluminum, ceiling mount only. Includes 6-inch Rigid Stem, alternate Stem lengths may be ordered separately. Field cuttable wiring included for up Stem length to a 48-inches.
- Locking mechanisms for Tilt (0° to 91°) and Rotation (365°)
- Six (6) Beam Distributions available: 12° Narrow Spot, 15° Spot, 22° Narrow Flood, 35° Medium Flood, 51° Flood, and 79° Wide Flood
- Narrow Spot and Spot Beam configurations utilize smaller LES LEDs to achieve beams and may not be used in higher wattage options (see Ordering Information for details)
- Optics are field interchangeable (with restrictions) and provide smooth, striation-free beams
- Luminaire may accept up to two (2) pieces of media (Lens or Louver), one (1) Snoot/Barn Door Assembly plus one (1) piece of media (Lens or Louver). Consult ordering information for proper combinations and sizes.
NOTE: Luminaire may hold one (1) LF16 60MM Series Lens or FA-16-60MM Louver;
Barn Doors may hold one LF18 Series Lens or LA-35 Louver
- Fixture weight: 3 LBS

DIMMING SPECIFICATIONS

- Incandescent 120V AC Dimmers adjust the light with *Forward Phase Control*, where the Dimmer “chops” the forward part of the AC Wave to deliver less or more power to the light source. No Neutral Wire Connection required.
- Electronic Low Voltage 120V AC Dimmers adjust the light with *Reverse Phase Control*, where the Dimmer “chops” the back part of the AC Wave to deliver less or more power to the light source. Neutral Wire Connection required.
- 0-10V Dimming may be used for 120V or 277V powered Luminaires by delivering a separate controlled DC voltage signal which adjusts the light output.

FORWARD/REVERSE PHASE COMPATIBLE DIMMERS			
MANUFACTURER	PRODUCT	MODEL	LIGHT OUTPUT
Leviton	Vizia	VPE06	4%-100%
Leviton	Decora	6673-10W	11%-100%
Lutron	Ariadni	TGCL-153P	0%-100%
Lutron	Diva	DVCL-153P	0%-100%
Lutron	Diva	DVELV303P	3%-100%
Lutron	Skylark	SELV300P	3%-100%
Lutron	Maestro	MAELV600	0%-100%
Lutron	Faetra	FAELV500	7%-100%
Lutron	Skylark C	SCL-153P	0%-100%
Lutron	Maestro C•L	MACL-153M	0%-99%
Lutron	RA2 Select	RRD-6CL	2%-98%

0-10V COMPATIBLE DIMMERS			
MANUFACTURER	PRODUCT	MODEL	LIGHT OUTPUT
Leviton	IlumaTech	IP710-DL	5% to 100%
Lutron	Diva	DVTV	5% to 100%
Lutron	Nova	NFTV	5% to 100%

NOTES

1. If light is measured, then the dimming range is based on light output. If light is not measured, then the dimming range is based on the percentage of output current.
2. Testing was performed with a single fixture connected to dimmer.
3. Testing has been performed on these dimmers, but this does not imply any warranty of compatibility.
4. Dimming performance can be influenced by different loads, as well as variations in dimmer switches within the same model.
5. Dimmer maximum load rating with LED may differ from published traditional source dimmer ratings. Consult manufacturer for maximum dimmer information.
6. Consult factory for additional dimming information.

CTL93 SERIES | Gallery M Track Luminaire Standard Luminous Photometry

CTL932NS3KD: 14W, 3000K, 83 CRI, NARROW SPOT BEAM

Test No. G25072304

Fixture Delivered Lumens: 1423.61
 Total Watts@120V: 14.7
 Lumens Per Watt: 96.84
 Center Beam Candle Power: 29580
 Beam Distribution: 11.6°
 Spacing Criterion: 0.19
 Color Rendering Index (CRI): 82.8
 Color Temperature (CCT): 3004K
 Designed for 50,000 Hour Lamp Life³

Intensity Distribution		
DISTANCE (FT.)	FOOTCANDLES (FC)	BEAM DIA. (FT.)
4 FT	1848.8	0.8
6 FT	821.7	1.2
8 FT	462.2	1.6
10 FT	295.8	2.0
12 FT	205.4	2.4
14 FT	150.9	2.9

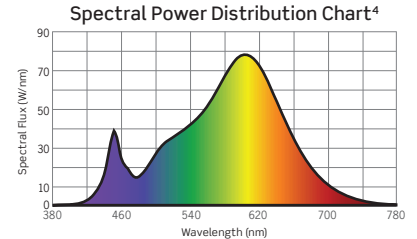
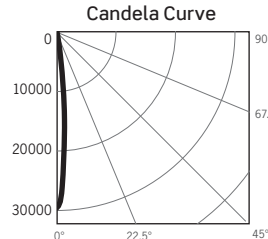

NARROW SPOT BEAM OUTPUT MULTIPLIERS
10W
0.74

CTL934SP3KD: 28W, 3000K, 83 CRI, SPOT BEAM

Test No. G25082504

Fixture Delivered Lumens: 2767.5
 Total Watts@120V: 28.7
 Lumens Per Watt: 96.43
 Center Beam Candle Power: 26608
 Beam Distribution: 14.8°
 Spacing Criterion: 0.27
 Color Rendering Index (CRI): 82.8
 Color Temperature (CCT): 3004K
 Designed for 50,000 Hour Lamp Life³

Intensity Distribution		
DISTANCE (FT.)	FOOTCANDLES (FC)	BEAM DIA. (FT.)
4 FT	1663.0	1.0
6 FT	739.1	1.6
8 FT	415.8	2.1
10 FT	266.1	2.6
12 FT	184.8	3.1
14 FT	135.8	3.6

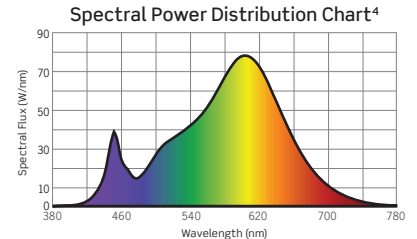
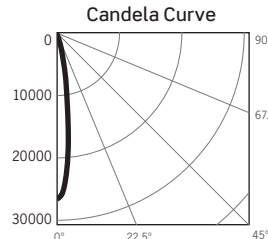

SPOT BEAM OUTPUT MULTIPLIERS		
10W	14W	19W
0.40	0.56	0.76

1. Accuracy of Rendering Colors 2. Color Appearance of Light Source 3. Dependent on Surrounding Temperatures 4. Colors Present within the Light Source

PHOTOMETRIC MULTIPLICATION FACTORS

Lumen output values fluctuate based on Color Temperature (CCT), Color Rendering Index (CRI), and Luminaire Wattage/Output. To estimate lumen output of the various options, multiply the 3000K standard CRI results by the following:

CCT	CCT MULTIPLIERS	
	STANDARD CRI	HIGH (90+) CRI
2700K	0.98	0.81
3000K	1.00	0.85
3500K	1.01	0.86
4000K	1.02	0.89

CTL93 SERIES | Gallery M Track Luminaire Standard Luminous Photometry

CTL935NF3KD: 35W, 3000K, 83 CRI, NARROW FLOOD BEAM

Test No. G25071703

Fixture Delivered Lumens: 3259.7
Total Watts@120V: 35.4
Lumens Per Watt: 92.08
Center Beam Candle Power: 17020
Beam Distribution: 21.6°
Spacing Criterion: 0.37
Color Rendering Index (CRI)¹: 82.8
Color Temperature (CCT)²: 3004K
Designed for 50,000 Hour Lamp Life³

Intensity Distribution		
DISTANCE (FT.)	FOOTCANDLES (FC)	BEAM DIA. (FT.)
4 FT	1063.7	1.5
6 FT	472.8	2.3
8 FT	265.9	3.1
10 FT	170.2	3.8
12 FT	118.2	4.6
14 FT	86.8	5.4

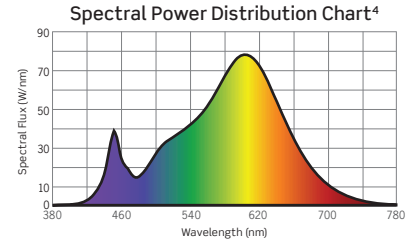
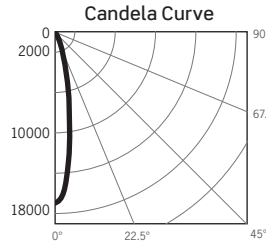

CTL935MF3KD: 35W, 3000K, 83 CRI, MEDIUM FLOOD BEAM

Test No. G25071702

Fixture Delivered Lumens: 3715.7
Total Watts@120V: 35.4
Lumens Per Watt: 104.96
Center Beam Candle Power: 9897
Beam Distribution: 35.2°
Spacing Criterion: 0.55
Color Rendering Index (CRI)¹: 82.8
Color Temperature (CCT)²: 3004K
Designed for 50,000 Hour Lamp Life³

Intensity Distribution		
DISTANCE (FT.)	FOOTCANDLES (FC)	BEAM DIA. (FT.)
4 FT	618.6	2.5
6 FT	274.9	3.8
8 FT	154.6	5.1
10 FT	99.0	6.3
12 FT	68.7	7.6
14 FT	50.5	8.9

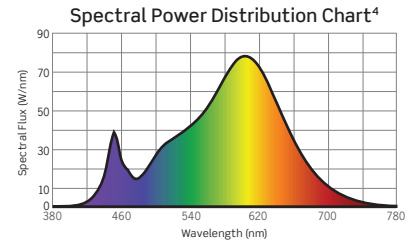
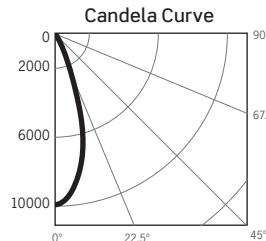

CTL935FL3KD: 35W, 3000K, 83 CRI, FLOOD BEAM

Test No. G25071701

Fixture Delivered Lumens: 3735.1
Total Watts@120V: 35.4
Lumens Per Watt: 105.51
Center Beam Candle Power: 6137
Beam Distribution: 51.8°
Spacing Criterion: 0.71
Color Rendering Index (CRI)¹: 82.8
Color Temperature (CCT)²: 3004K
Designed for 50,000 Hour Lamp Life³

Intensity Distribution		
DISTANCE (FT.)	FOOTCANDLES (FC)	BEAM DIA. (FT.)
4 FT	383.5	3.9
6 FT	170.5	5.8
8 FT	95.9	7.8
10 FT	61.4	9.7
12 FT	42.6	11.6
14 FT	31.3	13.6

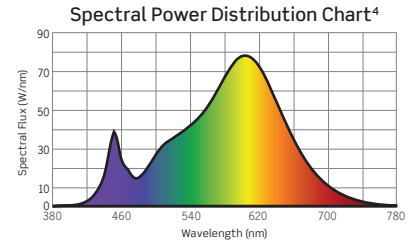
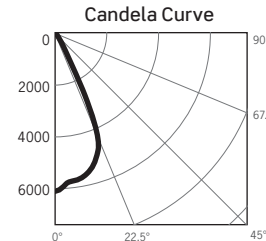

CTL934SP3KD: 35W, 3000K, 83 CRI, WIDE FLOOD BEAM

Test No. G25091601

Fixture Delivered Lumens: 3474.6
Total Watts@120V: 35.1
Lumens Per Watt: 99.00
Center Beam Candle Power: 2347
Beam Distribution: 79.4°
Spacing Criterion: 1.13
Color Rendering Index (CRI)¹: 82.8
Color Temperature (CCT)²: 3004K
Designed for 50,000 Hour Lamp Life³

Intensity Distribution		
DISTANCE (FT.)	FOOTCANDLES (FC)	BEAM DIA. (FT.)
4 FT	146.7	6.7
6 FT	65.2	10.0
8 FT	36.7	13.3
10 FT	23.5	16.6
12 FT	16.3	19.9
14 FT	12.0	23.3

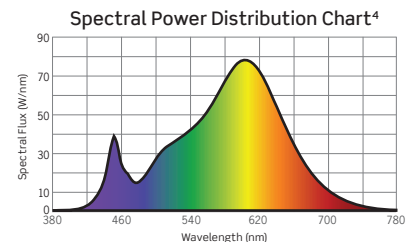
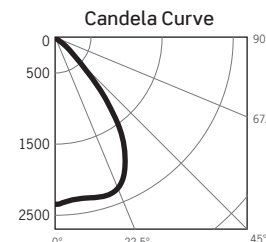

1. Accuracy of Rendering Colors 2. Color Appearance of Light Source 3. Dependent on Surrounding Temperatures 4. Colors Present within the Light Source

PHOTOMETRIC MULTIPLICATION FACTORS

Lumen output values fluctuate based on Color Temperature (CCT), Color Rendering Index (CRI), and Luminaire Wattage/Output. To estimate lumen output of the various options, multiply the 3000K standard CRI results by the following:

CCT	CCT MULTIPLIERS	
	STANDARD CRI	HIGH (90+) CRI
2700K	0.98	0.81
3000K	1.00	0.85
3500K	1.01	0.86
4000K	1.02	0.89

OUTPUT MULTIPLIERS			
10W	14W	19W	28W
0.30	0.42	0.59	0.79

CTL93 SERIES | Gallery M Track Luminaire Standard Luminous Photometry

TM-30 DATA: CTL935MF3KD

ANSI/IES TM-30-18 Color Rendition Report Test No. S21072001

Colors are for visual orientation purposes only

R_f	86
R_g	95
CCT(K)	3004K
D_{uv}	0.0007
u^l	0.2502
v^l	0.5222

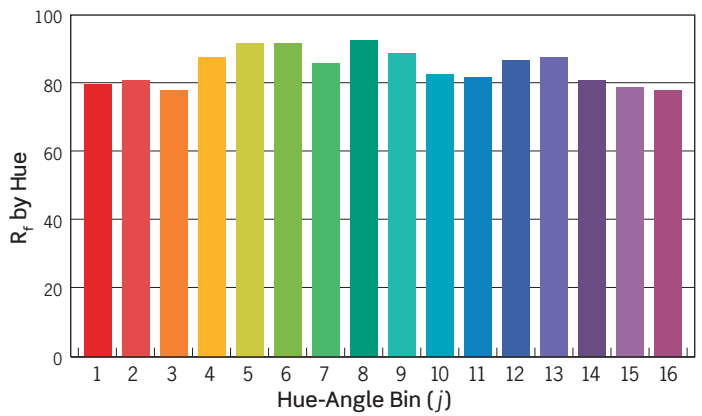
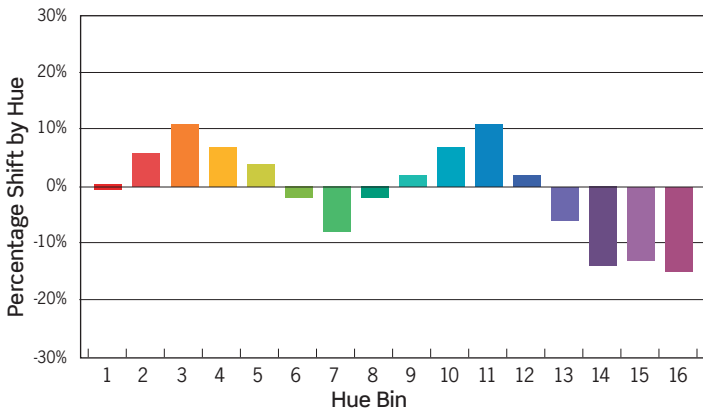
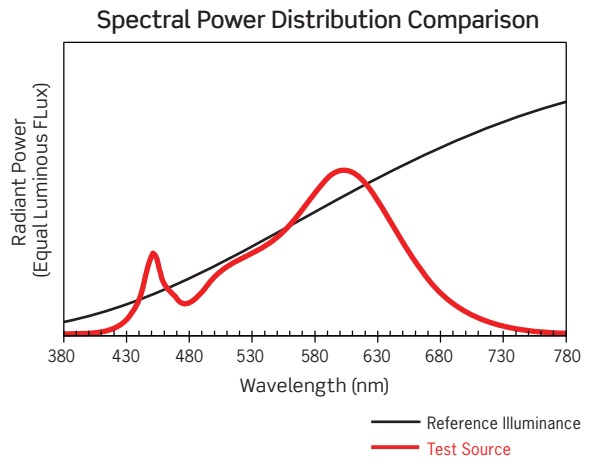
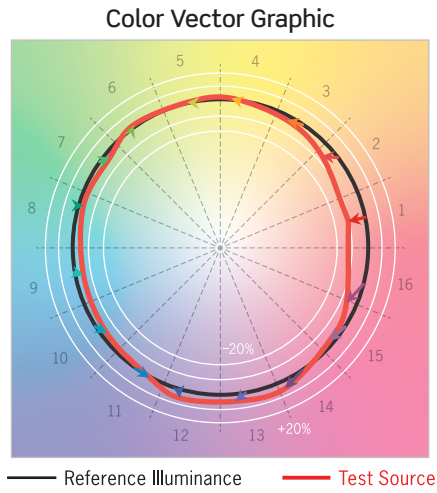

HUE BIN	1	2	3	4	5	6	7	8	9	10	11	12	13	14	15	16
HUE SHIFT	0%	7%	10%	6%	3%	-2%	-6%	-1%	3%	8%	11%	2%	-8%	-16%	-13%	-14%
R_f VALUE	80	82	80	91	94	94	88	94	90	86	84	87	88	80	79	78