

## CTL93C SERIES | Gallery M Canopy Mount Luminaire featuring Bridgelux® Warm Dim LED

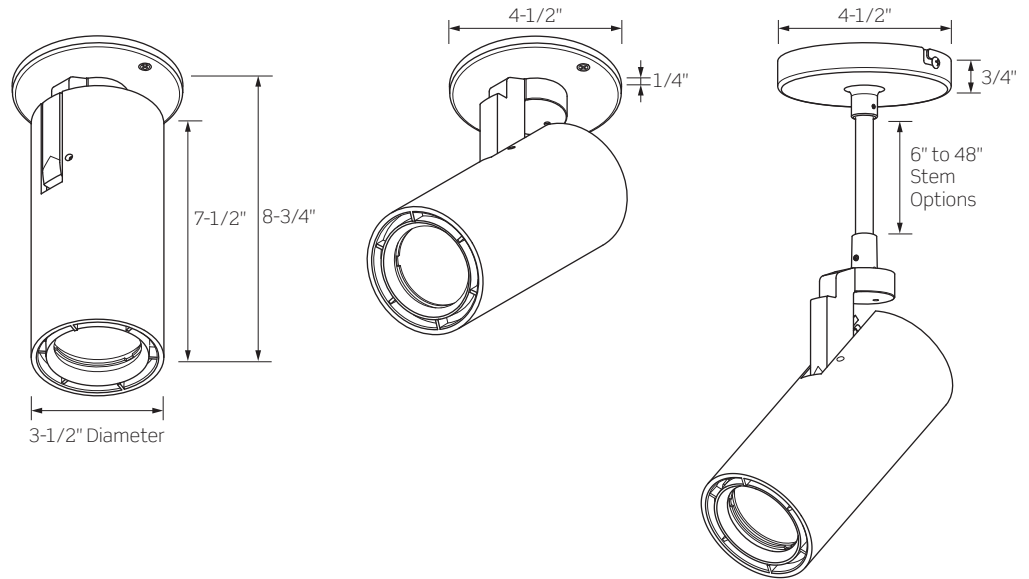

High performance luminaire delivering high outputs and superior beam control

- Clean aesthetics, simple cylinder form
- Multiple beam distributions
- Delivering up to 2400 Lumens
- Bridgelux® Vesta® Warm Dim LED; 3000K to 1800K



	CTL932C	CTL935C
WATTAGE	16W	35W
LUMEN OUTPUT <sup>1</sup> BY BEAM SPREAD		
Spot (14°)	1188Lm	N/A
Narrow Flood (22°)	N/A	2310Lm
Medium Flood (37°)	1158Lm	2524Lm
COLOR TEMPERATURE	3000K to 1800K (See Dimming Compatibility for low end CCT)	
CRI	95	
FINISHES	Matte Black / Matte White / Matte Silver	
DRIVER INPUT VOLTAGE	120V/277V, 50/60Hz	
DIMMING TYPE	120V Forward/Reverse Phase or 120V/277V 0-10V Dimming	
MOUNTING	Canopy option for ceiling or wall mount. Rigid Stem option for ceiling mount only.	
LISTINGS	cCSAus Certified for use in the U.S. and Canada; Suitable for Dry Locations	
WARRANTY	Five (5) year replacement after date of purchase	
SYSTEM RATING	50,000 Hours @ 70% Lumen Maintenance	

1. Approximate lumen output based on 3000K performance; see photometric test results for additional information

## CTL93C SERIES | Gallery M Canopy Mount Luminaire featuring Bridgelux® Warm Dim LED

### ORDERING INFORMATION

Example Order: CTL932CSPWDD-P

LED Series	Mounting Options	Beam Option	CCT/CRI	Driver	Finish	Alternate Stems	Finish
<b>CTL932</b> 16W <b>CTL935</b> 35W	<b>C</b> Mono-Point Canopy <b>CRS<sup>2</sup></b> Mono-Point Canopy with 6" Rigid Stem	<b>SP<sup>3</sup></b> Spot: 14° Beam / 30° Field <b>NF<sup>4</sup></b> Narrow Flood: 24° Beam / 45° Field <b>MF</b> Medium Flood: 38° Beam / 63° Field	95 CRI <b>WD</b> 3000K to 1800K	<b>MVD</b> 120V Forward/Reverse Phase Dimming <b>OR</b> 120V/277V 0-10V Dimming	<b>B</b> Matte Black <b>P</b> Matte White <b>S</b> Matte Silver	<b>12-STEM-A</b> 12-In. <b>18-STEM-A</b> 18-In. <b>24-STEM-A</b> 24-In. <b>30-STEM-A</b> 30-In. <b>36-STEM-A</b> 36-In. <b>48-STEM-A</b> 48-In.	<b>B</b> Matte Black <b>P</b> Matte White <b>S</b> Matte Silver

- 2. CRS Option includes 6-inch Rigid Stem and field cuttable wiring for Stem lengths up to 48-inches
- 3. Spot (SP) Beam is only available for Series 2 (16W)
- 4. Narrow Flood (NF) Beam is only available for Series 5 (35W)

### ACCESSORY & REPLACEMENT OPTIC ORDERING INFORMATION

Each Gallery M Luminaire may hold up to two (2) pieces of Media **OR** one (1) Snoot or Barn Door Assembly plus one (1) piece of Media



**Snoot with Optional Cross Blades**  
Exterior painted per finish selection: Black (B), White (P) or Silver (S). Interior and Cross Blades are always Black.

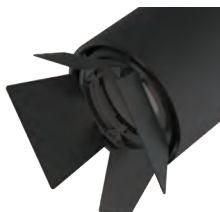

**Barn Doors**  
Black finish. Barn Doors may hold one LF18 Lens or LA-35 Honeycomb Louver.



**Honeycomb Louver**  
Black finish

Accessory
<b>FA-93</b> Snoot with optional Cross Blades

Finish
<b>B</b> Matte Black
<b>P</b> Matte White
<b>S</b> Matte Silver

Accessory
<b>BD93</b> Barn Doors

Finish
<b>B</b> Matte Black

Accessory
<b>FA-16-60MM</b> 2-3/8-In. Black Honeycomb Louver
<b>LA-35</b> 3-1/16-In. Black Honeycomb Louver for use within Barn Doors only



**Tempered Glass Filters and Lenses**  
1/8-Inch Thick, typ.

Accessory
<b>LF16</b> Tempered Glass Filters and Lenses
<b>LF18</b> Tempered Glass Filters and Lenses for use within Barn Doors only

Finish	
<b>C</b> Clear	<b>A</b> Amber
<b>SL</b> Soft Light	<b>B</b> Blue
<b>SOL</b> Solite	<b>LB</b> Light Blue
<b>LS</b> Linear Spread	<b>G</b> Green
<b>73</b> Spread	<b>R</b> Red
<b>UV</b> Optivex UV	<b>RO</b> Rose
	<b>Y</b> Yellow

Size
<b>60MM</b> 2-3/8-Inch <i>Leave Blank</i>
3-1/16-Inch LF18 Series for use within Barn Doors only

Replacement Optics
<b>CTL93WDOPT-SP<sup>3</sup></b> Spot Replacement 14° Beam / 30° Field
<b>CTL93WDOPT-NF<sup>4</sup></b> Narrow Flood Replacement 24° Beam / 45° Field
<b>CTL93WDOPT-MF</b> Medium Flood Replacement 38° Beam / 63° Field

- 3. Spot (SP) Beam is only available for Series 2 (16W)
- 4. Narrow Flood (NF) Beam is only available for Series 5 (35W)

# CTL93C SERIES | Gallery M Canopy Mount Luminaire featuring Bridgelux® Warm Dim LED

## PRODUCT SPECIFICATIONS

### PERFORMANCE SUMMARY

- Light that Warms as it Dims
- CCT Range from 3000K to 1800K (3000K at full brightness to 1800K when dimmed to <5%), CRI of 95
- Excellent fixture-to-fixture color consistency within a 3-step MacAdam Ellipse tolerance
- Precise beam control ensures that even at lower aiming angles the luminaire is glare free and quiet in the ceiling
- Full collection of accessories available to produce a myriad of filtering and framing effects
- 120V Forward or Reverse Dimming is standard for all wattage options. For dimmer compatibility and performance, refer to the Dimming Specifications below.

### CONSTRUCTION

- A revolutionary luminaire with superior optics designed to bring theatre grade beam control to traditional gallery and commercial track heads
- Constructed of die-cast aluminum, the cylindrical body provides thermal management for the luminaire
- Mono-Point Canopy Housing is constructed of cast aluminum, may be ceiling or wall mounted

- Mono-Point Canopy Housing with Rigid Stem is constructed of cast aluminum, ceiling mount only. Includes 6-inch Rigid Stem, alternate Stem lengths may be ordered separately. Field cuttable wiring included for up Stem length to a 48-inches.
- Locking mechanisms for Tilt (0° to 91°) and Rotation (365°)
- Three (3) Beam Distributions available: 14° Spot, 24° Narrow Flood, and 38° Medium Flood
- The Spot Beam configuration utilizes smaller LES LEDs to achieve beams and may not be used in higher wattage options (see Ordering Information for details)
- Optics are field interchangeable (with restrictions) and provide smooth, striation-free beams
- Luminaire may accept up to two (2) pieces of media (Lens or Louver), one (1) Snoot/Barn Door Assembly plus one (1) piece of media (Lens or Louver). Consult ordering information for proper combinations and sizes.
  - NOTE: Luminaire** may hold one (1) LF16 60MM Series Lens or FA-16-60MM Louver;
  - Barn Doors** may hold one LF18 Series Lens or LA-35 Louver
- Fixture weight: 3 LBS

## DIMMING SPECIFICATIONS

- Incandescent 120V AC Dimmers adjust the light with *Forward Phase Control*, where the Dimmer “chops” the forward part of the AC Wave to deliver less or more power to the light source. No Neutral Wire Connection required.
- Electronic Low Voltage 120V AC Dimmers adjust the light with *Reverse Phase Control*, where the Dimmer “chops” the back part of the AC Wave to deliver less or more power to the light source. Neutral Wire Connection required.
- 0-10V Dimming may be used for 120V or 277V powered Luminaires by delivering a separate controlled DC voltage signal which adjusts the light output.

FORWARD/REVERSE PHASE COMPATIBLE DIMMERS			
MANUFACTURER	PRODUCT	MODEL	LIGHT OUTPUT
Leviton	Vizia	VPE06	4%-100%
Leviton	Decora	6673-10W	11%-100%
Lutron	Ariadni	TGCL-153P	0%-100%
Lutron	Diva	DVCL-153P	0%-100%
Lutron	Diva	DVELV303P	3%-100%
Lutron	Skylark	SELV300P	3%-100%
Lutron	Maestro	MAELV600	0%-100%
Lutron	Faedora	FAELV500	7%-100%
Lutron	Skylark C	SCL-153P	0%-100%
Lutron	Maestro C•L	MACL-153M	0%-99%
Lutron	RA2 Select	RRD-6CL	2%-98%

0-10V COMPATIBLE DIMMERS			
MANUFACTURER	PRODUCT	MODEL	LIGHT OUTPUT
Leviton	IllumaTech	IP710-DL	5% to 100%
Lutron	Diva	DVTV	5% to 100%
Lutron	Nova	NFTV	5% to 100%

### NOTES

1. If light is measured, then the dimming range is based on light output. If light is not measured, then the dimming range is based on the percentage of output current.
2. Testing was performed with a single fixture connected to dimmer.
3. Testing has been performed on these dimmers, but this does not imply any warranty of compatibility.
4. Dimming performance can be influenced by different loads, as well as variations in dimmer switches within the same model.
5. Dimmer maximum load rating with LED may differ from published traditional source dimmer ratings. Consult manufacturer for maximum dimmer information.
6. Consult factory for additional dimming information.

# CTL93 SERIES | Gallery M Luminaire Bridgelux® Warm Dim LED Photometry

## CTL932SPWDD: 17W, 3000K, 95 CRI, SPOT BEAM

Test No. G25091703

Fixture Delivered Lumens: 1187.73  
 Total Watts@120V: 16.9  
 Lumens Per Watt: 70.28  
 Center Beam Candle Power: 11195  
 Beam Distribution: 14.4°  
 Spacing Criterion: 0.28  
 Color Rendering Index (CRI)<sup>1</sup>: 92.9  
 Color Temperature (CCT)<sup>2</sup>: 2924K  
 Designed for 50,000 Hour Lamp Life<sup>3</sup>

DISTANCE (FT.)	FOOTCANDLES (FC)	BEAM DIA. (FT.)
4 FT	699.7	1.0
6 FT	311.0	1.5
8 FT	174.9	2.0
10 FT	111.9	2.5
12 FT	77.7	3.0
14 FT	57.1	3.5

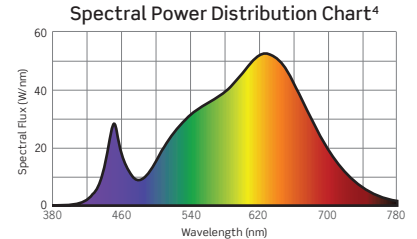
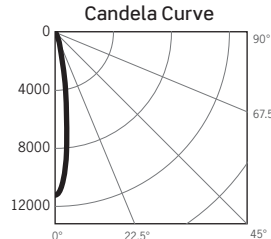

## CTL932MFWDD: 17W, 3000K, 95 CRI, MEDIUM FLOOD BEAM

Test No. G25091702

Fixture Delivered Lumens: 1158.27  
 Total Watts@120V: 16.9  
 Lumens Per Watt: 68.54  
 Center Beam Candle Power: 3188  
 Beam Distribution: 36.0°  
 Spacing Criterion: 0.53  
 Color Rendering Index (CRI)<sup>1</sup>: 92.9  
 Color Temperature (CCT)<sup>2</sup>: 2924K  
 Designed for 50,000 Hour Lamp Life<sup>3</sup>

DISTANCE (FT.)	FOOTCANDLES (FC)	BEAM DIA. (FT.)
4 FT	199.3	2.6
6 FT	88.6	3.9
8 FT	49.8	5.2
10 FT	31.9	6.5
12 FT	22.1	7.8
14 FT	16.3	9.1

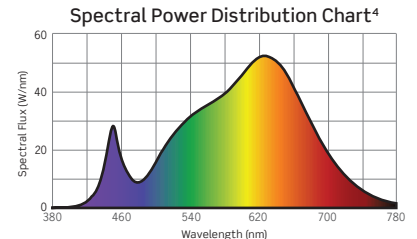
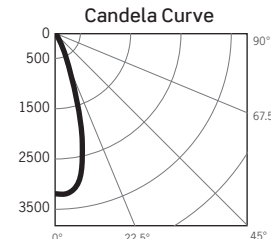

## CTL935NFWDD: 35W, 3000K, 95 CRI, NARROW FLOOD BEAM

Test No. G25091701

Fixture Delivered Lumens: 2309.59  
 Total Watts@120V: 35.5  
 Lumens Per Watt: 65.06  
 Center Beam Candle Power: 12050  
 Beam Distribution: 22.0°  
 Spacing Criterion: 0.37  
 Color Rendering Index (CRI)<sup>1</sup>: 92.9  
 Color Temperature (CCT)<sup>2</sup>: 2924K  
 Designed for 50,000 Hour Lamp Life<sup>3</sup>

DISTANCE (FT.)	FOOTCANDLES (FC)	BEAM DIA. (FT.)
4 FT	753.1	1.6
6 FT	334.7	2.3
8 FT	188.3	3.1
10 FT	120.5	3.9
12 FT	83.7	4.7
14 FT	61.5	5.4

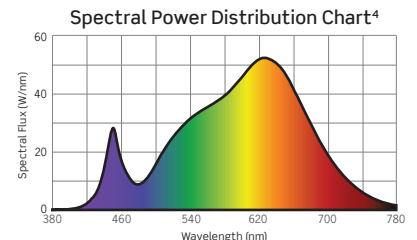
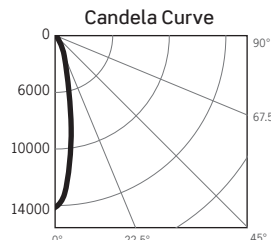

## CTL935MFWDD: 35W, 3000K, 95 CRI, MEDIUM FLOOD BEAM

Test No. G25091602

Fixture Delivered Lumens: 2524.46  
 Total Watts@120V: 35.6  
 Lumens Per Watt: 70.91  
 Center Beam Candle Power: 5896  
 Beam Distribution: 38.0°  
 Spacing Criterion: 0.58  
 Color Rendering Index (CRI)<sup>1</sup>: 92.9  
 Color Temperature (CCT)<sup>2</sup>: 2924K  
 Designed for 50,000 Hour Lamp Life<sup>3</sup>

DISTANCE (FT.)	FOOTCANDLES (FC)	BEAM DIA. (FT.)
4 FT	368.5	2.8
6 FT	163.8	4.1
8 FT	92.1	5.5
10 FT	59.0	6.9
12 FT	40.9	8.3
14 FT	30.1	9.6

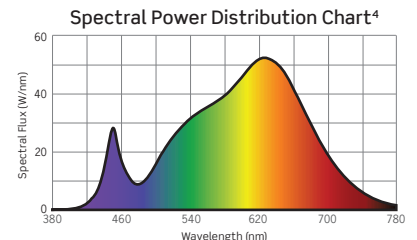
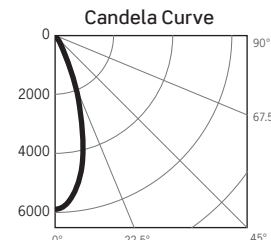

1. Accuracy of Rendering Colors 2. Color Appearance of Light Source 3. Dependent on Surrounding Temperatures 4. Colors Present within the Light Source

**CTL93 SERIES** | Gallery M Luminaire Bridgelux® Warm Dim LED Photometry

**TM-30 DATA: CTL935MFWDD - AT FULL BRIGHTNESS**

ANSI/IES TM-30-18 Color Rendition Report Test No. S25091701

Colors are for visual orientation purposes only

$R_f$	90
$R_g$	103
CCT(K)	2924K
$D_{uv}$	-0.0024
$u^l$	0.2541
$v^l$	0.5195

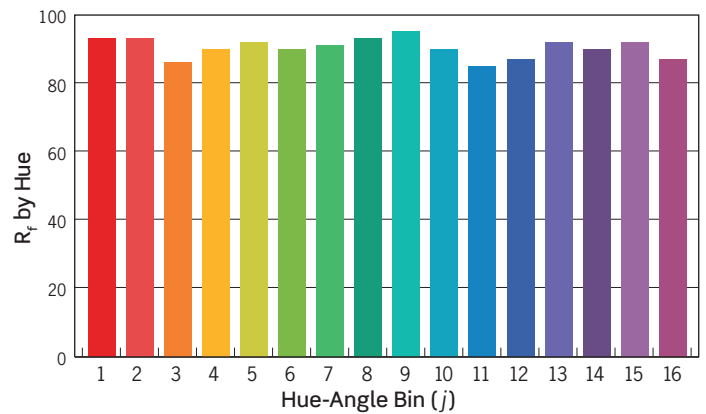
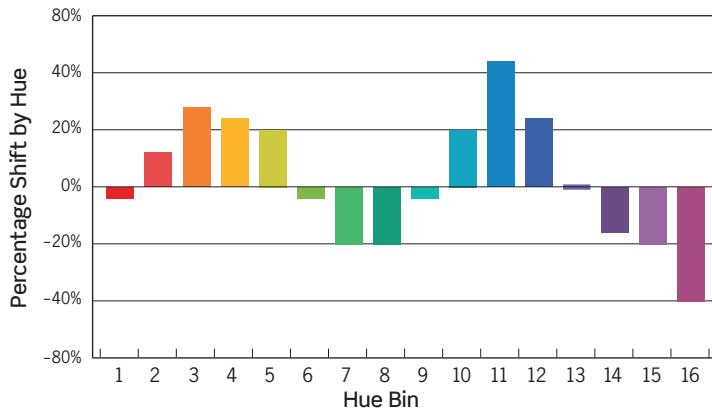
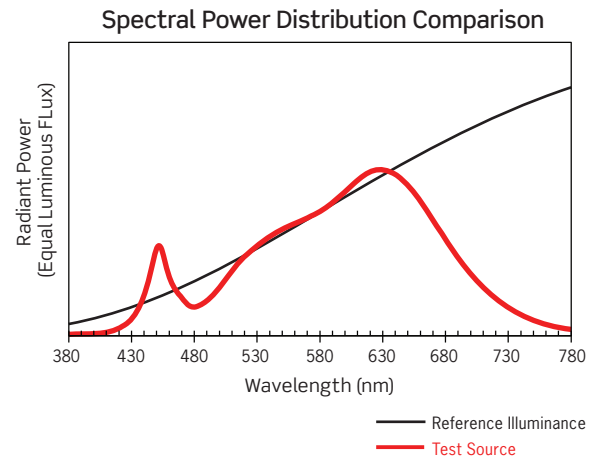
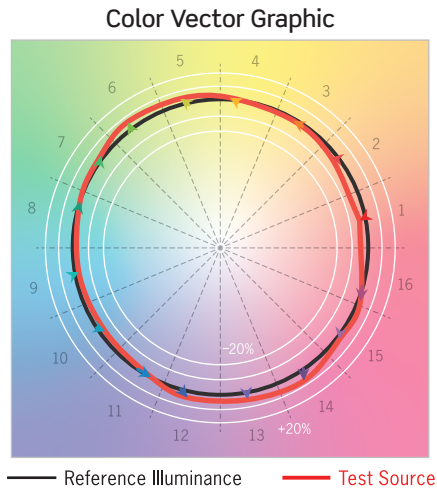

HUE BIN	1	2	3	4	5	6	7	8	9	10	11	12	13	14	15	16
HUE SHIFT	-1%	3%	7%	6%	5%	-1%	-5%	-5%	-1%	5%	11%	6%	0%	-4%	-5%	-10%
$R_f$ VALUE	93	93	86	90	92	90	91	93	95	90	85	87	92	90	92	87