

NCTL93 SERIES | Gallery M Track Luminaire for 2C/2N Nordic Track Systems

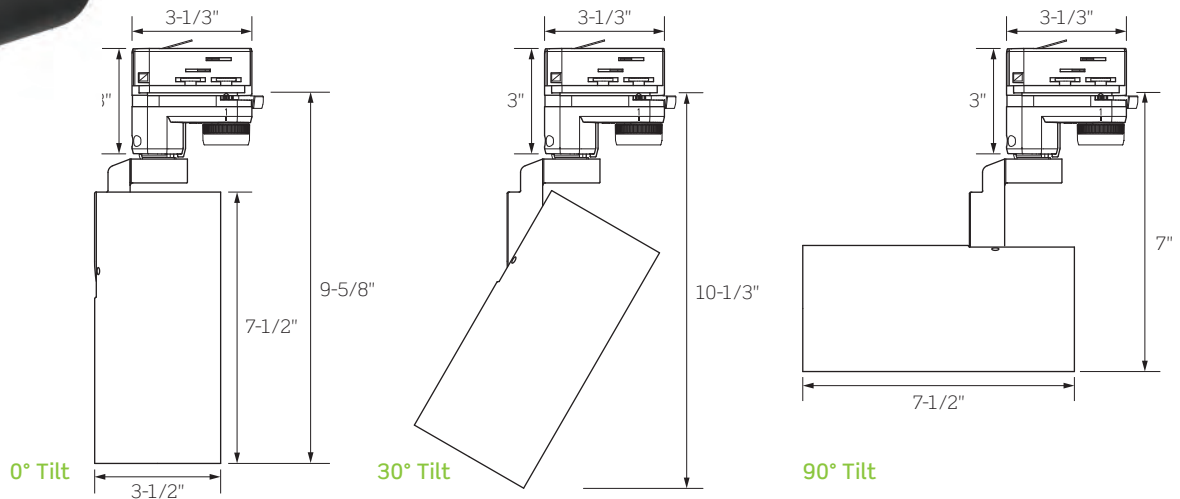

High performance track luminaire delivering high outputs and superior beam control

- Clean aesthetics, simple cylinder form
- Multiple beam distributions
- Delivering up to 3,700 Lumens
- Consistent color rendering



	NCTL931	NCTL932	NCTL933	NCTL934	NCTL935
WATTAGE	10W	14W	19W	28W	35W
LUMEN OUTPUT ¹ BY BEAM SPREAD					
Narrow Spot (12°)	1058 Lm	1424 Lm	N/A	N/A	N/A
Spot (15°)	1110 Lm	1536 Lm	2108 Lm	2768 Lm	N/A
Narrow Flood (22°)	981 Lm	1374 Lm	1914 Lm	2587 Lm	3260 Lm
Medium Flood (35°)	1118 Lm	1566 Lm	2182 Lm	2949 Lm	3716 Lm
Flood (52°)	1124 Lm	1574 Lm	2193 Lm	2964 Lm	3735 Lm
Wide Flood (79°)	1046 Lm	1464 Lm	2040 Lm	2758 Lm	3475 Lm
COLOR TEMPERATURE	2700K / 3000K / 3500K / 4000K				
CRI	83 (80min) / 90+				
FINISHES	Matte Black / Matte White / Matte Silver				
DRIVER INPUT VOLTAGE	120V, 50/60Hz				
DIMMING TYPE	120V Forward/Reverse Phase Dimming				
COMPATIBILITY	Compatible with Global/Nordic Aluminum Inc. Track Systems				
LISTINGS	cCSAus Certified for use in the U.S. and Canada; Suitable for Dry Locations				
WARRANTY	Five (5) year replacement after date of purchase				
SYSTEM RATING	50,000 Hours @ 70% Lumen Maintenance				

1. Approximate lumen output based on 3000K performance; see photometric test results for additional information

NCTL93 SERIES | Gallery M Track Luminaire for 2C/2N Nordic Track Systems

ORDERING INFORMATION

Example Order: NCTL932SP3KD-P1C

LED Series	Beam Option	CCT/CRI		Driver	Finish	Nordic Adapter	
NCTL931 10W	NS² Narrow Spot: 12° Beam / 21° Field	80+ CRI	90+ CRI	D 120V Forward/Reverse Phase Dimming	B Matte Black	Nordic NTEK 120V 2C/2N Leave Blank	
NCTL932 14W	SP³ Spot: 15° Beam / 31° Field	27K 2700K	27KC 2700K		P Matte White	27 Nordic NHTEK 277V 2C/2N	
NCTL933 19W	NF Narrow Flood: 22° Beam / 45° Field	3K 3000K	3KC 3000K			S Matte Silver	1C Nordic ECO 120V 1C/1N or 2C/1N
NCTL934 28W	MF Medium Flood: 35° Beam / 56° Field	35K 3500K	35KC 3500K				3C Nordic Pro 120V 3C/1N
NCTL935 35W	FL Flood: 52° Beam / 62° Field WF Wide Flood: 79° Beam / 101° Field	4K 4000K	4KC 4000K				

2. Narrow Spot (NS) Beam is only available for Series 1 (10W) and Series 2 (14W)
3. Spot (SP) Beam is only available for Series 1 (10W) through Series 4 (28W)

ACCESSORY & REPLACEMENT OPTIC ORDERING INFORMATION

Each Gallery M Luminaire may hold up to two (2) pieces of Media **OR** one (1) Snoot or Barn Door Assembly plus one (1) piece of Media



Snoot
with *Optional Cross Blades*
Exterior painted per finish selection: Black (B), White (P) or Silver (S). Interior and Cross Blades are always Black.

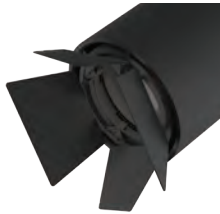

Barn Doors
Black finish. Barn Doors may hold one LF18 Lens or LA-35 Honeycomb Louver.



Honeycomb Louver
Black finish

Accessory
FA-93 Snoot with optional Cross Blades

Finish
B Matte Black
P Matte White
S Matte Silver

Accessory
BD93 Barn Doors

Finish
B Matte Black

Accessory
FA-16-60MM 2-3/8-In. Black Honeycomb Louver
LA-35 3-1/16-In. Black Honeycomb Louver for use within Barn Doors only



Tempered Glass Filters and Lenses
1/8-Inch Thick, typ.

Accessory
LF16 Tempered Glass Filters and Lenses
LF18 Tempered Glass Filters and Lenses for use within Barn Doors only

Finish	
C Clear	A Amber
SL Soft Light	B Blue
SOL Solite	LB Light Blue
LS Linear Spread	G Green
	R Red
	RO Rose
	Y Yellow

Size
60MM 2-3/8-Inch <i>Leave Blank</i>
3-1/16-Inch LF18 Series for use within Barn Doors only

Replacement Optics
CTL930PT-NS⁴ Narrow Spot Replacement 12° Beam / 21° Field
CTL930PT-SP⁵ Spot Replacement 15° Beam / 31° Field
CTL930PT-NF Narrow Flood Replacement 22° Beam / 45° Field
CTL930PT-MF Medium Flood Replacement 35° Beam / 56° Field
CTL930PT-FL Flood Replacement 52° Beam / 62° Field
CTL930PT-WF Wide Flood Replacement 79° Beam / 101° Field

4. Narrow Spot (CTL930PT-NS) Optic is only for use on luminaires originally ordered with NS Optic
5. Spot (CTL930PT-SP) Optic is only for use on luminaires originally ordered with SP Optic

NCTL93 SERIES | Gallery M Track Luminaire for 2C/2N Nordic Track Systems

PRODUCT SPECIFICATIONS

PERFORMANCE SUMMARY

- 2700K, 3000K, 3500K and 4000K CCTs; 80 CRI min., 83 typical; high CRI of 90+ available
- Excellent fixture-to-fixture color consistency with a 2-step MacAdam Ellipse tolerance
- Precise beam control ensures that even at lower aiming angles the luminaire is glare free and quiet in the ceiling
- Full collection of accessories available to produce a myriad of filtering and framing effects
- 120V Forward or Reverse Dimming is standard for all wattage options. For dimmer compatibility and performance, refer to the Dimming Specifications below.

CONSTRUCTION

- A revolutionary track head with superior optics designed to bring theatre grade beam control to traditional gallery and commercial track heads
- Constructed of die-cast aluminum, the cylindrical body provides thermal management for the luminaire
- Locking mechanisms for Tilt (0° to 91°) and Rotation (365°)
- Six (6) Beam Distributions available: 12° Narrow Spot, 15° Spot, 22° Narrow Flood, 35° Medium Flood, 51° Flood, and 79° Wide Flood
- Narrow Spot and Spot Beam configurations utilize smaller LES LEDs to achieve beams and may not be used in higher wattage options (see Ordering Information for details)

- Optics are field interchangeable (with restrictions) and provide smooth, striation-free beams
- Luminaire may accept up to two (2) pieces of media (Lens or Louver), one (1) Snoot/Barn Door Assembly plus one (1) piece of media (Lens or Louver). Consult ordering information for proper combinations and sizes. **NOTE: Luminaire** may hold one (1) LF16 60MM Series Lens or FA-16-60MM Louver; **Barn Doors** may hold one LF18 Series Lens or LA-35 Louver
- Integral ON/OFF switch and track polarity indicator are standard
- Fixture weight: 3 LBS

FIXTURE COMPATIBILITY

- Compatible with Nordic Aluminum Inc. TEK100 Track Systems
- ConTech can switch out the standard Nordic TEK00 adapter with either the GES66 or GA100 adapters for compatibility with other Nordic Aluminum Inc. Track Systems
- For more information, consult factory

DIMMING SPECIFICATIONS

- Incandescent 120V AC Dimmers adjust the light with *Forward Phase Control*, where the Dimmer “chops” the forward part of the AC Wave to deliver less or more power to the light source. No Neutral Wire Connection required.
- Electronic Low Voltage 120V AC Dimmers adjust the light with *Reverse Phase Control*, where the Dimmer “chops” the back part of the AC Wave to deliver less or more power to the light source. Neutral Wire Connection required.

FORWARD/REVERSE PHASE COMPATIBLE DIMMERS			
MANUFACTURER	PRODUCT	MODEL	LIGHT OUTPUT
Leviton	Vizia	VPE06	4%-100%
Leviton	Decora	6673-10W	11%-100%
Lutron	Ariadni	TGCL-153P	0%-100%
Lutron	Diva	DVCL-153P	0%-100%
Lutron	Diva	DVELV303P	3%-100%
Lutron	Skylark	SELV300P	3%-100%
Lutron	Maestro	MAELV600	0%-100%
Lutron	Faetra	FAELV500	7%-100%
Lutron	Skylark C	SCL-153P	0%-100%
Lutron	Maestro C•L	MAEL-153M	0%-99%
Lutron	RA2 Select	RRD-6CL	2%-98%

NOTES

1. If light is measured, then the dimming range is based on light output. If light is not measured, then the dimming range is based on the percentage of output current.
2. Testing was performed with a single fixture connected to dimmer.
3. Testing has been performed on these dimmers, but this does not imply any warranty of compatibility.
4. Dimming performance can be influenced by different loads, as well as variations in dimmer switches within the same model.
5. Dimmer maximum load rating with LED may differ from published traditional source dimmer ratings. Consult manufacturer for maximum dimmer information.
6. Consult factory for additional dimming information.

CTL93 SERIES | Gallery M Track Luminaire Standard Luminous Photometry

CTL932NS3KD: 14W, 3000K, 83 CRI, NARROW SPOT BEAM

Test No. G25072304

Fixture Delivered Lumens: 1423.61
 Total Watts@120V: 14.7
 Lumens Per Watt: 96.84
 Center Beam Candle Power: 29580
 Beam Distribution: 11.6°
 Spacing Criterion: 0.19
 Color Rendering Index (CRI): 82.8
 Color Temperature (CCT): 3004K
 Designed for 50,000 Hour Lamp Life³

Intensity Distribution		
DISTANCE (FT.)	FOOTCANDLES (FC)	BEAM DIA. (FT.)
4 FT	1848.8	0.8
6 FT	821.7	1.2
8 FT	462.2	1.6
10 FT	295.8	2.0
12 FT	205.4	2.4
14 FT	150.9	2.9

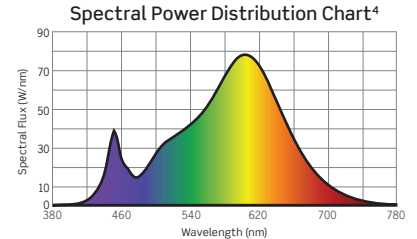
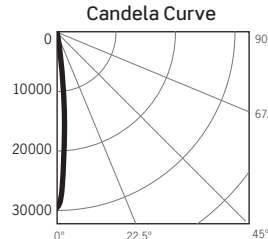

NARROW SPOT BEAM OUTPUT MULTIPLIERS
10W
0.74

CTL934SP3KD: 28W, 3000K, 83 CRI, SPOT BEAM

Test No. G25082504

Fixture Delivered Lumens: 2767.5
 Total Watts@120V: 28.7
 Lumens Per Watt: 96.43
 Center Beam Candle Power: 26608
 Beam Distribution: 14.8°
 Spacing Criterion: 0.27
 Color Rendering Index (CRI): 82.8
 Color Temperature (CCT): 3004K
 Designed for 50,000 Hour Lamp Life³

Intensity Distribution		
DISTANCE (FT.)	FOOTCANDLES (FC)	BEAM DIA. (FT.)
4 FT	1663.0	1.0
6 FT	739.1	1.6
8 FT	415.8	2.1
10 FT	266.1	2.6
12 FT	184.8	3.1
14 FT	135.8	3.6

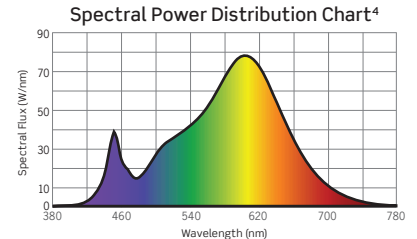
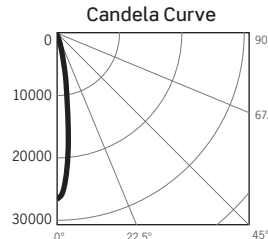

SPOT BEAM OUTPUT MULTIPLIERS		
10W	14W	19W
0.40	0.56	0.76

1. Accuracy of Rendering Colors 2. Color Appearance of Light Source 3. Dependent on Surrounding Temperatures 4. Colors Present within the Light Source

PHOTOMETRIC MULTIPLICATION FACTORS

Lumen output values fluctuate based on Color Temperature (CCT), Color Rendering Index (CRI), and Luminaire Wattage/Output. To estimate lumen output of the various options, multiply the 3000K standard CRI results by the following:

CCT	CCT MULTIPLIERS	
	STANDARD CRI	HIGH (90+) CRI
2700K	0.98	0.81
3000K	1.00	0.85
3500K	1.01	0.86
4000K	1.02	0.89

CTL93 SERIES | Gallery M Track Luminaire Standard Luminous Photometry

CTL935NF3KD: 35W, 3000K, 83 CRI, NARROW FLOOD BEAM

Test No. G25071703

Fixture Delivered Lumens: 3259.7
 Total Watts@120V: 35.4
 Lumens Per Watt: 92.08
 Center Beam Candle Power: 17020
 Beam Distribution: 21.6°
 Spacing Criterion: 0.37
 Color Rendering Index (CRI)¹: 82.8
 Color Temperature (CCT)²: 3004K
 Designed for 50,000 Hour Lamp Life³

DISTANCE (FT.)	FOOTCANDLES (FC)	BEAM DIA. (FT.)
4 FT	1063.7	1.5
6 FT	472.8	2.3
8 FT	265.9	3.1
10 FT	170.2	3.8
12 FT	118.2	4.6
14 FT	86.8	5.4

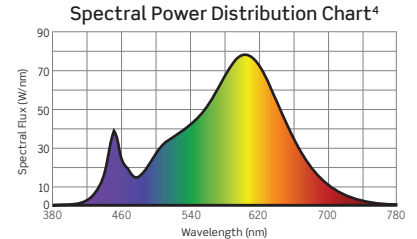
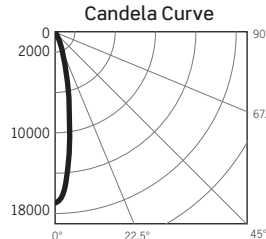

CTL935MF3KD: 35W, 3000K, 83 CRI, MEDIUM FLOOD BEAM

Test No. G25071702

Fixture Delivered Lumens: 3715.7
 Total Watts@120V: 35.4
 Lumens Per Watt: 104.96
 Center Beam Candle Power: 9897
 Beam Distribution: 35.2°
 Spacing Criterion: 0.55
 Color Rendering Index (CRI)¹: 82.8
 Color Temperature (CCT)²: 3004K
 Designed for 50,000 Hour Lamp Life³

DISTANCE (FT.)	FOOTCANDLES (FC)	BEAM DIA. (FT.)
4 FT	618.6	2.5
6 FT	274.9	3.8
8 FT	154.6	5.1
10 FT	99.0	6.3
12 FT	68.7	7.6
14 FT	50.5	8.9

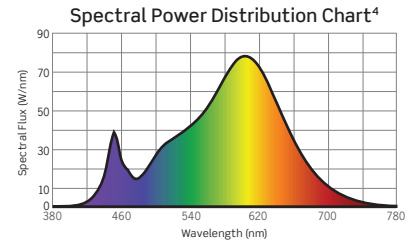
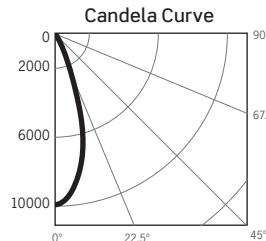

CTL935FL3KD: 35W, 3000K, 83 CRI, FLOOD BEAM

Test No. G25071701

Fixture Delivered Lumens: 3735.1
 Total Watts@120V: 35.4
 Lumens Per Watt: 105.51
 Center Beam Candle Power: 6137
 Beam Distribution: 51.8°
 Spacing Criterion: 0.71
 Color Rendering Index (CRI)¹: 82.8
 Color Temperature (CCT)²: 3004K
 Designed for 50,000 Hour Lamp Life³

DISTANCE (FT.)	FOOTCANDLES (FC)	BEAM DIA. (FT.)
4 FT	383.5	3.9
6 FT	170.5	5.8
8 FT	95.9	7.8
10 FT	61.4	9.7
12 FT	42.6	11.6
14 FT	31.3	13.6

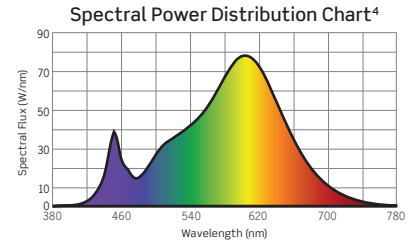
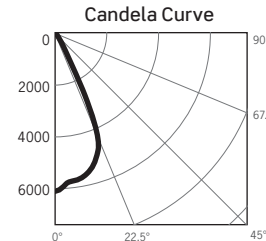

CTL934SP3KD: 35W, 3000K, 83 CRI, WIDE FLOOD BEAM

Test No. G25091601

Fixture Delivered Lumens: 3474.6
 Total Watts@120V: 35.1
 Lumens Per Watt: 99.00
 Center Beam Candle Power: 2347
 Beam Distribution: 79.4°
 Spacing Criterion: 1.13
 Color Rendering Index (CRI)¹: 82.8
 Color Temperature (CCT)²: 3004K
 Designed for 50,000 Hour Lamp Life³

DISTANCE (FT.)	FOOTCANDLES (FC)	BEAM DIA. (FT.)
4 FT	146.7	6.7
6 FT	65.2	10.0
8 FT	36.7	13.3
10 FT	23.5	16.6
12 FT	16.3	19.9
14 FT	12.0	23.3

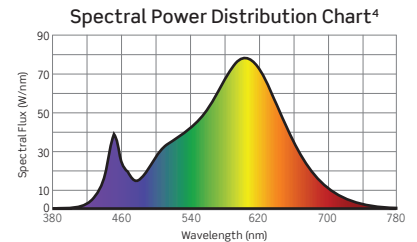
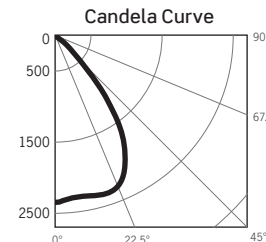

1. Accuracy of Rendering Colors 2. Color Appearance of Light Source 3. Dependent on Surrounding Temperatures 4. Colors Present within the Light Source

PHOTOMETRIC MULTIPLICATION FACTORS

Lumen output values fluctuate based on Color Temperature (CCT), Color Rendering Index (CRI), and Luminaire Wattage/Output. To estimate lumen output of the various options, multiply the 3000K standard CRI results by the following:

CCT	CCT MULTIPLIERS	
	STANDARD CRI	HIGH (90+) CRI
2700K	0.98	0.81
3000K	1.00	0.85
3500K	1.01	0.86
4000K	1.02	0.89

OUTPUT MULTIPLIERS			
10W	14W	19W	28W
0.30	0.42	0.59	0.79

CTL93 SERIES | Gallery M Track Luminaire Standard Luminous Photometry

TM-30 DATA: CTL935MF3KD

ANSI/IES TM-30-18 Color Rendition Report Test No. S21072001

Colors are for visual orientation purposes only

R_f	86
R_g	95
CCT(K)	3004K
D_{uv}	0.0007
u^l	0.2502
v^l	0.5222

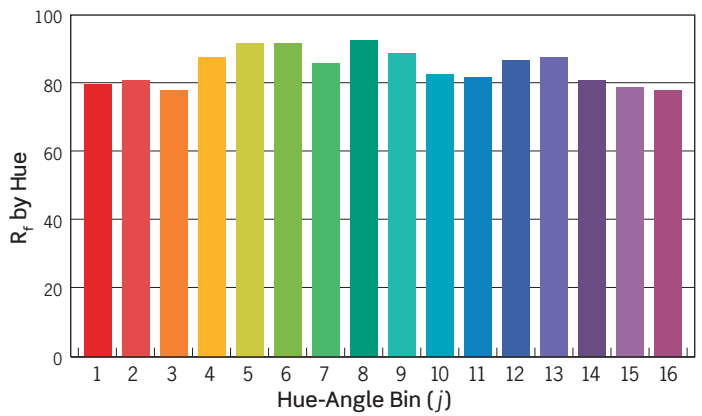
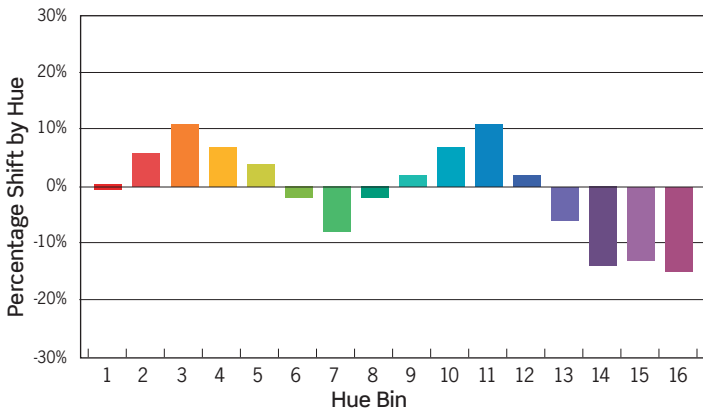
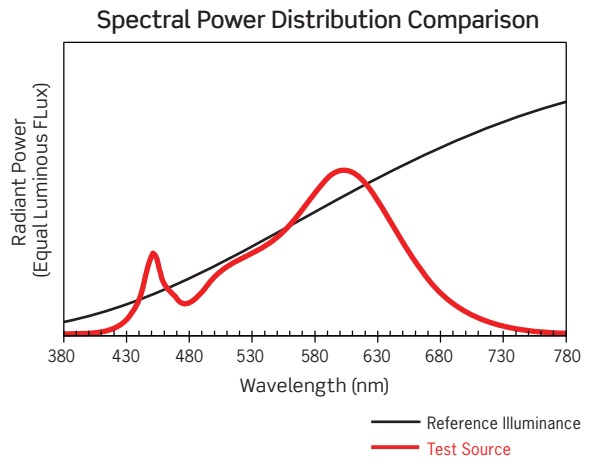
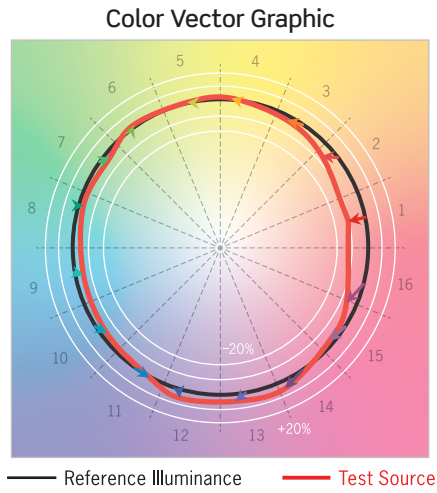

HUE BIN	1	2	3	4	5	6	7	8	9	10	11	12	13	14	15	16
HUE SHIFT	0%	7%	10%	6%	3%	-2%	-6%	-1%	3%	8%	11%	2%	-8%	-16%	-13%	-14%
R_f VALUE	80	82	80	91	94	94	88	94	90	86	84	87	88	80	79	78