

DATE PROJECT TYPE

CYL6 SERIES | 6 Inch Indoor/Outdoor Round Cylinders: Wall Mount





Down Light: **W**

Up Light: **U**

Nominal Weight: 6.0Lbs

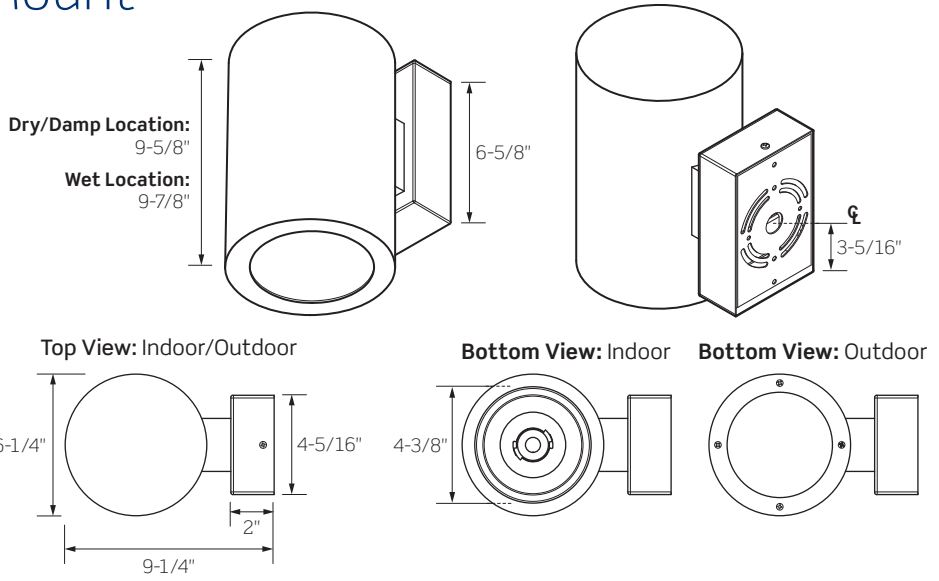
Wall Mount Cylinders available in the Up or Down orientation



	CYL61	CYL62	CYL63	CYL64	CYL65	CYL66
WATTAGE	10W	14W	20W	28W	36W	43W
LUMEN OUTPUT ¹	1220Lm	1685Lm	2300Lm	3100Lm	3850Lm	4350Lm
COLOR TEMPERATURE	2700K / 3000K / 3500K / 4000K					
CRI	83 (80min) / 90+					
REFLECTOR BEAM	36° / 54° / 63° / 80° / Wall Wash / Pencil Beam					
REFLECTOR FINISHES	Clear Alzak (Narrow, Medium, Wide) / Platinum (Medium)					
CYLINDER FINISHES	Matte Black / Satin Bronze / Matte White / Matte Silver / Custom Colors Available					
DRIVER INPUT WATTAGE	10W	14W	20W	28W	36W	43W
INPUT CURRENT (A) 120V/277V	.08/.04	.12/.06	.17/.08	.23/.11	.31/.14	.36/.16
INPUT VOLTAGE/DIMMING TYPE	Std Driver (TRIAC, ELV, 0-10V) 120VAC/277VAC, 50/60Hz Lutron HiLume® Driver 120VAC, 50/60Hz Lutron Eco-System® Driver 120VAC/277VAC, 50/60Hz eldoLED ECOdrive/SOLOdrive 120VAC/277VAC, 50/60Hz					
DIMMING RANGE	Std Driver (TRIAC, ELV, 0-10V) 10-100% Lutron HiLume® Driver 1-100% Lutron Eco-System® Driver 1-100% eldoLED ECOdrive/SOLOdrive 0.1-100%					
DRIVER POWER FACTOR	> 0.90					
TOTAL HARMONIC DISTORTION	< 20%					
LISTINGS	 cCSAus Certified for use in the U.S. and Canada; Suitable for Damp/Dry or Wet locations Wet Location Models have a Silicone Sealed Clear Glass Lens in a Gasketed Die-Cast Trim Ring to ensure unit is watertight ENERGY STAR® Certified; Pencil Beam and Wall Wash options are not ENERGY STAR® Certified All models must be installed per specific product installation instructions and all appropriate National Electrical Codes					
WARRANTY	Five (5) year replacement after date of purchase					
SYSTEM RATING	50,000 Hours @ 70% Lumen Maintenance					

1. Approximate lumen output based on 3000K performance; see photometric test results for additional information

DATE

PROJECT

TYPE

CYL6 SERIES | 6 Inch Indoor/Outdoor Round Cylinders: Wall Mount

ORDERING INFORMATION

Example Order: - -

Cylinder LED Series	Color Temp/CRI	Driver/Dimming	Mounting	Mntg Location	Reflector Beam
CYL61 - 10W/1220lm	83 (80min) CRI	MVD - 120V-277V TRIAC, ELV, 0-10V Dimming	W - Down Light Wall Mount	- Interior Dry/Damp Locations, Leave Blank	NCLR - 36° Narrow, Clear Alzak
CYL62 - 14W/1685lm	27K - 2700K	34D2 - 347V 0-10V Dimming	U - Up Light Wall Mount	X - Exterior/Wet Locations	MCLR - 54° Medium, Clear Alzak
CYL63 - 20W/2300lm	30K - 3000K	12D3¹ - Lutron Hi-lume 1% 2-Wire LED Driver (120V Forward Phase Only)			WCLR - 80° Wide, Clear Alzak
CYL64 - 28W/3100lm	35K - 3500K	MVD4² - Lutron Hi-lume 1% EcoSystem LED Driver with Soft-on, Fade-to-Black			PL - 63° Platinum
CYL65 - 36W/3850lm	40K - 4000K	MVD6 - eldoLED ECOdrive 0-10V, 1% Dimming			WW - Wall Wash
CYL66 - 43W/4350lm	90+ CRI	MVD7 - eldoLED ECOdrive DALI, 1% Dimming			PB³ - Pencil Beam
	27KC - 2700K	MVD8 - eldoLED SOLOdrive 0-10V, 0.1% Dimming			
	30KC - 3000K	MVD9 - eldoLED SOLOdrive DALI, 0.1% Dimming			
	35KC - 3500K	MDMX - eldoLED POWERdrive DMX <1% Dimming			
	40KC - 4000K				

Finish

- B** - Matte Black
- BZ** - Satin Bronze
- P** - Matte White
- S** - Matte Silver
- CC⁴** - Custom Color

Battery and Remote Enclosure^{5,6}

- None, Leave Blank
- RDB** - Remote Driver & Battery Pack
- RD** - Remote Driver Enclosure

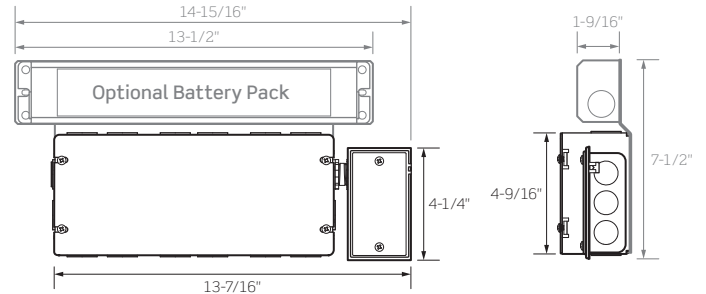

- Lutron Dimming Option 12D3 Hi-lume 1% 2-Wire LED Driver is available for Series 1 through 3 luminaires only (10W through 20W); not available for use with Series 4, 5 or 6 (28W, 36W or 43W) luminaires
- Lutron Dimming Option MVD4 Hi-lume 1% EcoSystem LED Driver is available for Series 1 through 4 luminaires only (10W through 28W); not available for use with Series 5 or 6 (36W or 43W) luminaires
- Pencil Beam (PB) Optic limited to Exterior Mount (X Mounting option) locations
- Custom Finish colors available; consult factory for pricing, minimum order quantities and lead time
- RDB and RD Options must be installed in Dry/Damp locations
- RDB and RD Options cannot be used with Lutron Hi-lume Dimming (12D3/MVD4 Options) in Series 5 or 6 (36W or 43W) luminaires

RDB: Remote Driver & Battery Pack
Battery Flexible Conduit Whips Not Pictured
RD: Remote Driver Enclosure

DRIVER AVAILABILITY MATRIX

Highest wattage option for each Driver/Dimmer type that will fit inside the luminaire;
Driver sizes that do not fit inside the luminaire may be ordered with a Remote Driver Housing (RD), unless otherwise noted with additional restrictions.

Driver	Max Wattage	Driver	Max Wattage	Driver	Max Wattage
MVD 120V-277V TRIAC/ELV	Any Wattage	MVD6 eldoLED ECOdrive 0-10V	Any Wattage	MVD9 eldoLED SOLOdrive DALI	Any Wattage
12D3⁵ 120V Lutron Hi-lume 1% 2-Wire	Up to 28W (CYL64)	MVD7 eldoLED ECOdrive DALI	Any Wattage	MDMX eldoLED POWERdrive DMX	Any Wattage
MVD4⁵ Lutron Hi-lume 1% EcoSystem	Up to 28W (CYL64)	MVD8 eldoLED SOLOdrive 0-10V	Any Wattage	34D2 347V 0-10V	Any Wattage

DATE

PROJECT

TYPE

CYL6 SERIES | 6 Inch Indoor/Outdoor Round Cylinders: Wall Mount

PRODUCT DETAILS

Construction

- Specification Grade 6 inch diameter Aluminum Housing; suitable for Dry/Damp (indoor) or Wet (outdoor) location types
- Wet Location Cylinders feature a Silicone Sealed Clear Glass Lens in a Gasketed Die-Cast Trim Ring to ensure unit is watertight
- Bracket Support for hands-free wiring
- Available in Up or Down mounting orientation; specific mounting style must ordered from factory

Performance Summary

- Clear Alzak Reflector is available in 36° Narrow, 54° Medium and 80° Wide beam distributions
- Platinum Reflector is available in a 63° Medium beam distribution
- Wall Wash and Pencil Beam Optic accessories are also available
- 2700K, 3000K, 3500K and 4000K Color Temperatures; CRI 80 of min., 83 typical; high CRI 90+ available
- Excellent fixture-to-fixture color consistency within a 3-step MacAdam Ellipse tolerance
- Battery Backup option provides 90 minutes of power
- UL8750 and Class 2 compliant: RoHS compliant, U.S. only
- Output over voltage, over current and short circuit protected
- CYL6 Cylinders are available for non-dimming and dimming applications; for dimmer compatibility, refer to Dimming Specification sheet

BUG RATINGS

Valid for all mountings except Up (U) Wall Mount

LED WATTAGE	REFLECTOR					
	NARROW	MEDIUM	WIDE	PLATINUM	WALL WASH ¹	PENCIL BEAM
10W	B1 U0 G0	B1 U0 G0	B1 U0 G1	B1 U0 G1	B0 U0 G0	B0 U0 G0
14W	B1 U0 G0	B2 U0 G0	B2 U0 G0	B2 U0 G0	B0 U0 G0	B0 U0 G0
20W	B1 U0 G0	B2 U0 G0	B2 U0 G0	B2 U0 G0	B0 U0 G0	B0 U0 G0
28W	B1 U0 G0	B2 U0 G0	B2 U0 G0	B2 U0 G0	B0 U0 G0	B0 U0 G0
36W	B2 U0 G0	B3 U0 G0	B3 U0 G1	B3 U0 G1	B1 U0 G0	B0 U0 G0
43W	B2 U0 G0	B3 U0 G0	B3 U0 G1	B3 U0 G1	B1 U0 G0	B0 U0 G0

1. Wall Wash Rating based on Reflector used as Forward Throw

DATE

PROJECT

TYPE

CYL6 SERIES | 6 Inch Indoor/Outdoor Round Cylinders: Photometrics

CYL6630KMVDCNCLR

Fixture Delivered Lumens: 4301.9
 Total Watts@120V: 42.3
 Lumens Per Watt: 101.7
 Center Beam Candle Power: 7111
 Beam Distribution: 35.7°
 Spacing Criterion: 0.64
 Color Rendering Index (CRI)¹: 83.6
 Color Temperature (CCT)²: 3086K
 Designed for 50,000 Hour Lamp Life³
 LM-63 Test No. G21080504
 LM-79 Test No. S21081101

Intensity Distribution

DISTANCE (FT.)	FOOTCANDLES (FC)	BEAM DIAMETER (FT.)
4 FT	444.5	2.6
6 FT	197.5	3.9
8 FT	111.1	5.1
10 FT	71.1	6.4
12 FT	49.4	7.7
14 FT	36.3	9.0

Candela Curve

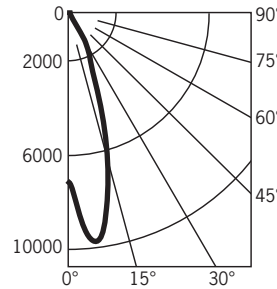

Spectral Power Distribution Chart⁴

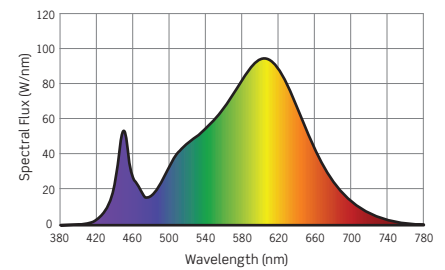

CYL6630KMVDCMCLR

Fixture Delivered Lumens: 4348.9
 Total Watts@120V: 42.3
 Lumens Per Watt: 102.8
 Center Beam Candle Power: 6032
 Beam Distribution: 53.3°
 Spacing Criterion: 0.80
 Color Rendering Index (CRI)¹: 83.6
 Color Temperature (CCT)²: 3086K
 Designed for 50,000 Hour Lamp Life³
 LM-63 Test No. G16122002
 LM-79 Test No. S21081101

Intensity Distribution

DISTANCE (FT.)	FOOTCANDLES (FC)	BEAM DIAMETER (FT.)
4 FT	377.0	4.0
6 FT	167.6	6.0
8 FT	94.2	8.0
10 FT	60.3	10.1
12 FT	41.9	12.1
14 FT	30.8	14.1

Candela Curve

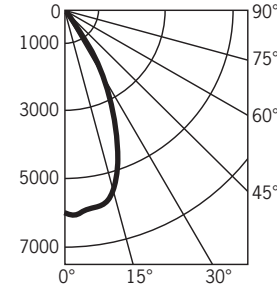

Spectral Power Distribution Chart⁴

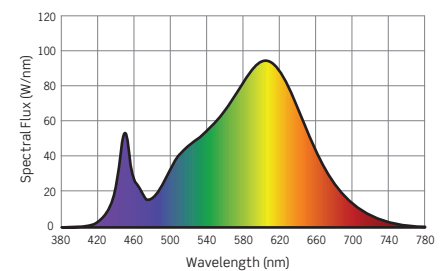

CYL6630KMVDCWCLR

Fixture Delivered Lumens: 4153.7
 Total Watts@120V: 42.3
 Lumens Per Watt: 98.2
 Center Beam Candle Power: 2367
 Beam Distribution: 79.9°
 Spacing Criterion: 1.20
 Color Rendering Index (CRI)¹: 83.6
 Color Temperature (CCT)²: 3086K
 Designed for 50,000 Hour Lamp Life³
 LM-63 Test No. G16122003
 LM-79 Test No. S21081101

Intensity Distribution

DISTANCE (FT.)	FOOTCANDLES (FC)	BEAM DIAMETER (FT.)
4 FT	147.9	6.7
6 FT	65.7	10.1
8 FT	37.0	13.4
10 FT	23.7	16.8
12 FT	16.4	20.1
14 FT	12.1	23.5

Candela Curve

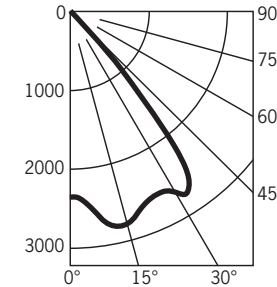

Spectral Power Distribution Chart⁴

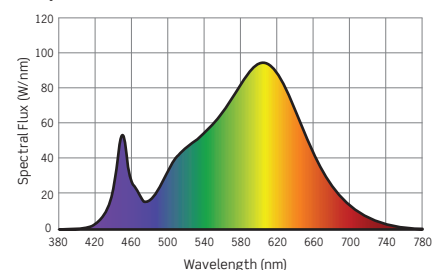

1. Accuracy of Rendering Colors 2. Color Appearance of Light Source 3. Dependent on Surrounding Temperatures 4. Colors Present within the Light Source

PHOTOMETRIC MULTIPLICATION FACTORS

Lumen output values fluctuate based on Color Temperature, Luminaire Wattage/Output and Trim Selection. To estimate lumen output of these various options, multiply 3000K results by the following:

CCT MULTIPLIERS			OUTPUT MULTIPLIERS				
CCT	STD CRI	HIGH CRI	10W/SERIES 1	14W/SERIES 2	20W/SERIES 3	28W/SERIES 4	36W/SERIES 5
2700K	0.94	0.70	0.28	0.39	0.53	0.72	0.89
3000K	N/A	0.75					
3500K	1.0	0.81					
4000K	1.0	0.87					

DATE

PROJECT

TYPE

CYL6 SERIES | 6 Inch Indoor/Outdoor Round Cylinders: Photometrics

CYL6630KMVDCPL

Fixture Delivered Lumens: 3801.8
 Total Watts@120V: 42.3
 Lumens Per Watt: 89.9
 Center Beam Candle Power: 4413
 Beam Distribution: 63.0°
 Spacing Criterion: 0.93
 Color Rendering Index (CRI)¹: 83.6
 Color Temperature (CCT)²: 3086K
 Designed for 50,000 Hour Lamp Life³
 LM-63 Test No. G21080602
 LM-79 Test No. S21081101

Intensity Distribution

DISTANCE (FT.)	FOOTCANDLES (FC)	BEAM DIAMETER (FT.)
4 FT	275.8	4.9
6 FT	122.6	7.4
8 FT	69.0	9.8
10 FT	44.1	12.2
12 FT	30.6	14.7
14 FT	22.5	17.1

Candela Curve

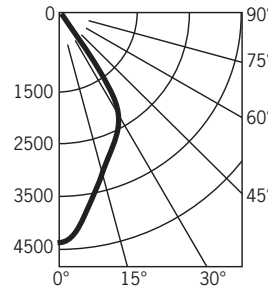

Spectral Power Distribution Chart⁴

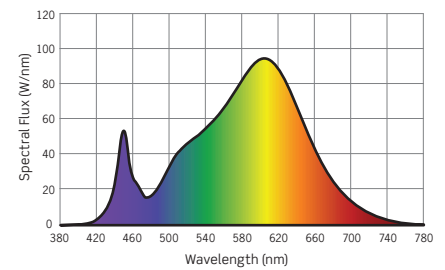

CYL6630KMVDCWW

Fixture Delivered Lumens: 1900.3
 Total Watts@120V: 42.0
 Lumens Per Watt: 45.2
 Center Beam Candle Power: 1820
 Beam Distribution: Wall Wash
 Spacing Criterion: 0.83
 Color Rendering Index (CRI)¹: 83.6
 Color Temperature (CCT)²: 3086K
 Designed for 50,000 Hour Lamp Life³
 LM-63 Test No. G21080603
 LM-79 Test No. S21081101

Intensity Distribution

DISTANCE (FT.)	FOOTCANDLES (FC)	BEAM DIAMETER (FT.)
4 FT	113.8	3.8
6 FT	50.6	5.7
8 FT	28.4	7.7
10 FT	18.2	9.6
12 FT	12.6	11.5
14 FT	9.3	13.4

Candela Curve

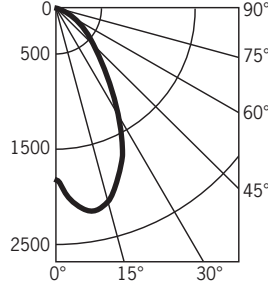

Spectral Power Distribution Chart⁴

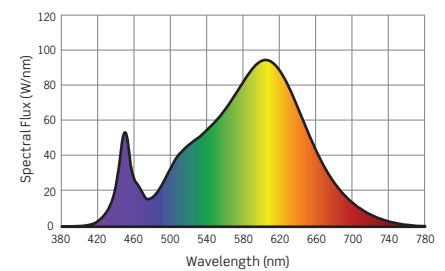

CYL6630KMVDCXPB

Fixture Delivered Lumens: 291.2
 Total Watts@120V: 42.0
 Lumens Per Watt: 6.9
 Center Beam Candle Power: 766
 Beam Distribution: 9°
 Spacing Criterion: 0.94
 Color Rendering Index (CRI)¹: 83.6
 Color Temperature (CCT)²: 3086K
 Designed for 50,000 Hour Lamp Life³
 LM-63 Test No. G21080901
 LM-79 Test No. S21081101

Intensity Distribution

DISTANCE (FT.)	FOOTCANDLES (FC)	BEAM DIAMETER (FT.)
4 FT	47.9	3.5
6 FT	21.3	5.3
8 FT	12.0	7.1
10 FT	7.7	8.8
12 FT	5.3	10.6
14 FT	3.9	12.4

Candela Curve

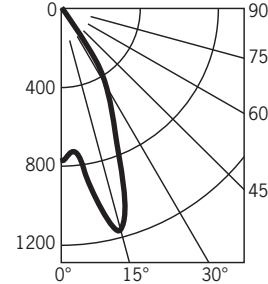

Spectral Power Distribution Chart⁴

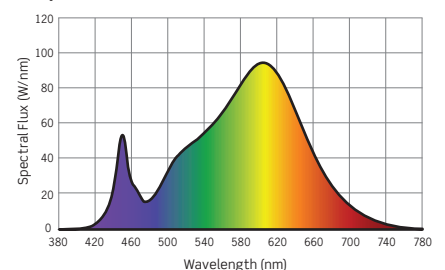

1. Accuracy of Rendering Colors 2. Color Appearance of Light Source 3. Dependent on Surrounding Temperatures 4. Colors Present within the Light Source

PHOTOMETRIC MULTIPLICATION FACTORS

Lumen output values fluctuate based on Color Temperature, Luminaire Wattage/Output and Trim Selection. To estimate lumen output of these various options, multiply 3000K results by the following:

CCT MULTIPLIERS			OUTPUT MULTIPLIERS				
CCT	STD CRI	HIGH CRI	10W/SERIES 1	14W/SERIES 2	20W/SERIES 3	28W/SERIES 4	36W/SERIES 5
2700K	0.94	0.70	0.28	0.39	0.53	0.72	0.89
3000K	N/A	0.75					
3500K	1.0	0.81					
4000K	1.0	0.87					

DATE

PROJECT

TYPE

CYL6 SERIES | 6 Inch Indoor/Outdoor Round Cylinders: Photometrics

TM-30 DATA: CYL630KMVDCMCLR

ANSI/IES TM-30-18 Color Rendition Report Test No. S21081101

Colors are for visual orientation purposes only

R_f	86
R_g	97
CCT(K)	3086K
D_{uv}	0.0017
u^l	0.2470
v^l	0.5220

Color Vector Graphic

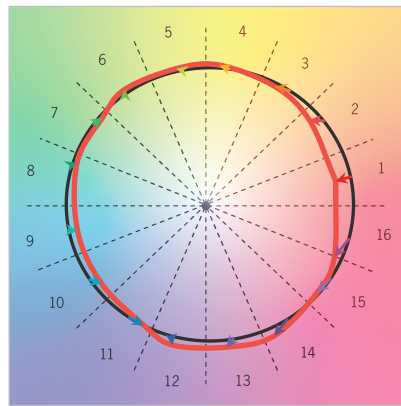

— Reference Illuminance — Test Source

Spectral Power Distribution Comparison

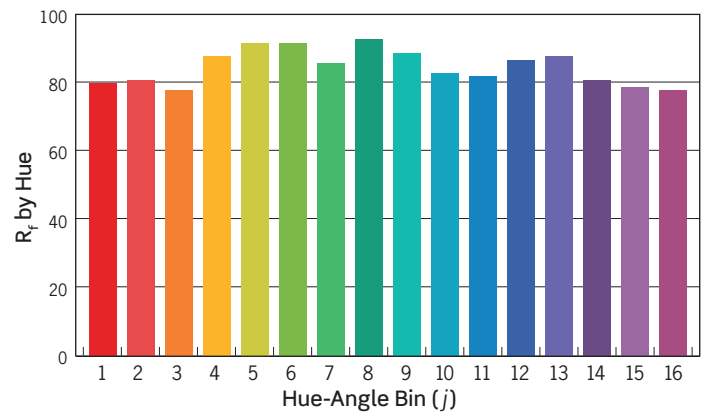
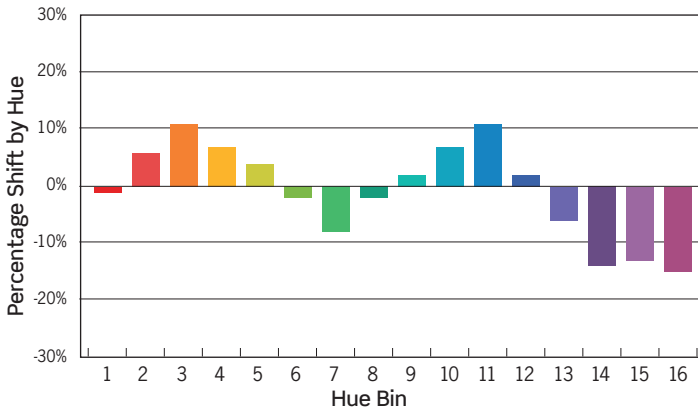
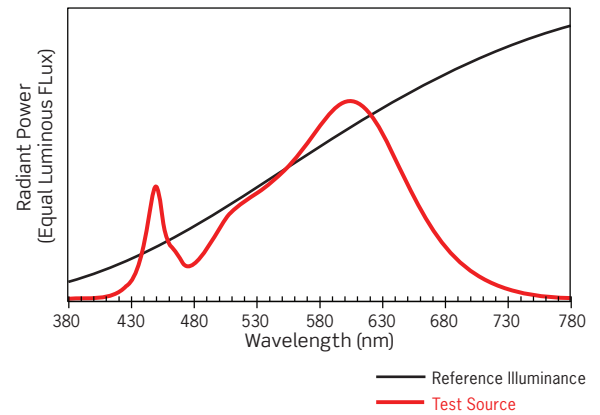

HUE BIN	1	2	3	4	5	6	7	8	9	10	11	12	13	14	15	16
HUE SHIFT	-1%	6%	10%	7%	4%	-2%	-7%	-2%	2%	7%	11%	2%	-6%	-14%	-13%	-15%
R _f VALUE	81	83	80	89	93	93	88	94	91	84	83	88	89	82	80	80

CYL6 SERIES | 6 Inch Indoor/Outdoor Round Cylinders: Dimming Specifications

- Incandescent 120VAC Dimmers adjust the light with “forward phase control,” where the dimmer “chops” the forward part of the AC wave to deliver less or more power to the light source. No neutral wire connection required.
- Electronic Low Voltage 120VAC dimmers adjust the light with “reverse phase control,” where the dimmer “chops” the back part of the AC wave to deliver less or more power to the light source. Neutral wire connection required.
- 0-10V DC Low Voltage Dimmers operate using two (2) low voltage dimming wires that are separate from the 120V or 277V AC power. The Dimmer sends a variable output voltage to the luminaire based upon the dimming level. 10V Corresponds to undimmed operation, 5V to 50% and so on. Switching On/Off is controlled with the line voltage power (120V or 277V AC) input to the Dimmer and then dimming operation is controlled with the 0-10V DC low voltage wiring connection between the Dimmer and the LED Driver. The control signal runs on two (2) low voltage control wires (color coded Purple and Pink/Grey).
- Lutron HiLume and EcoSystem Drivers provide continuous dimming from 1%-100%. For a complete list of compatible dimmers and controls, please visit www.lutron.com
- Use DALI approved controls for dimming eldoLED MVD7 (1%-100%) and MVD9 (0.1%-100%) options.

Manufacturer	Product	Model	MVD	MVD6	MVD8
			Dimming Option	Dimming Option	Dimming Option
			Light Output	Light Output	Light Output
Leviton	IllumaTech	IPI06-1LZ	1%-100%	NA	NA
Leviton	SureSlide	6631-2	1%-100%	NA	NA
Leviton	Vizia	VPE06	9%-100%	NA	NA
Leviton	Trimatron	6683-IW	6%-100%	NA	NA
Leviton	Decora	6161	15%-100%	NA	NA
Leviton	SureSlide	6633-P	1%-100%	NA	NA
Leviton	IllumaTech	IPE04	6%-100%	NA	NA
Leviton	IllumaTech	IP710-DLX	NA	1%-100%	0.1%-100%
Cooper	Devine	DLC03P	1%-100%	NA	NA
Cooper	Skye	SLC03P	0%-100%	NA	NA
Cooper	Decorator	DAL06P	0%-100%	NA	NA
Pass & Seymour	Titan	CD4FB-W	NA	1%-100%	0.1%-100%
Synergy		ISD BC	NA	1%-100%	0.1%-100%
Watt Stopper	Miro Decorator	DCLV1	NA	1%-100%	0.1%-100%
Lutron	Ariadni	TGCL-153P	1%-100%	NA	NA
Lutron	Ariadni	TG-600P	13%-100%	NA	NA
Lutron	Diva	DVCL-153P	1%-100%	NA	NA
Lutron	Diva	DV600P	6%-100%	NA	NA
Lutron	Diva	DVELV303P	6%-100%	NA	NA
Lutron	Diva	DVTV	NA	1%-100%	0.1%-100%
Lutron	Faetra	FAELV500	12%-100%	NA	NA
Lutron	Lumea	LG600P	8%-100%	NA	NA
Lutron	Maestro	MAELV600	16%-100%	NA	NA
Lutron	Nova	NFTV	NA	1%-100%	0.1%-100%
Lutron	Nova T	NTFTV	NA	1%-100%	0.1%-100%
Lutron	Skylark	S-603PG	5%-96%	NA	NA
Lutron	Skylark	S600P	5%-100%	NA	NA
Lutron	Skylark	SELV300P	10%-100%	NA	NA
Lutron	Skylark	CT103P	9%-100%	NA	NA

*277V Triac Dimming is not available

NOTES

1. Testing was performed with a single fixture connected to dimmer.
2. Testing has been performed on these dimmers, but this does not imply any warranty of compatibility.
3. Dimming performance can be influenced by different loads, as well as variations in dimmer switches within the same model.
4. Dimmer maximum load rating with LED may differ from published traditional source dimmer ratings. Consult manufacturer for maximum dimmer information.
5. Consult factory for additional dimming information.