

Odyssey Line Voltage Flexible Track System

120V Luminaires

Specifications/Features

Odyssey Line Voltage Flexible Track System offers unique visual interest over standard ceiling track. Luminaires are crafted from high quality materials to provide years of appealing illumination with an integrated adapter to ensure a solid electrical connection and simplified installation. Luminaires are available in a silver finish to create a modern style in many

different environments. No transformer is required for the line voltage fixture offering. All luminaires carry ConTech's one year full replacement guarantee after installation. See specific luminaires for lamp type and maximum wattage, lamps are sold separately. All luminaires are cCSAus Certified for dry locations.

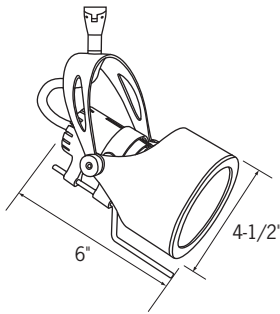

Bolos

Accepts LF20 Series filters
Lamp: 75W max. PAR30, E26 Med. Base



LIR830-S

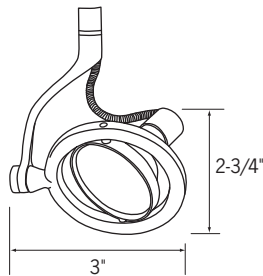

Lika Spot

Dual Swivel lampholder. Rear lampholder allows use of (1) LF16 series lens or FA-16 filter.
Lamp: 50W max. PAR16 GU10 base



LIR596-S

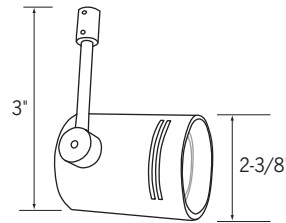

Bima Spot

Lamp: 50W max. PAR16 GU10 base



LIR697-S

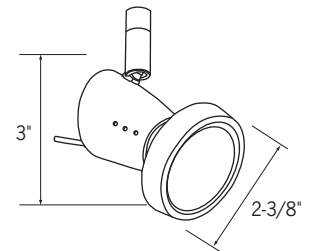

Risa with Ring

Lamp: 50W max. PAR16, GU10 base



LIR4537-S

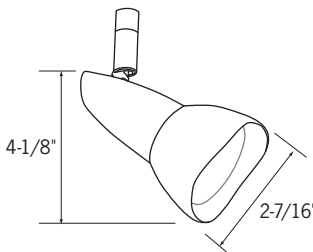

Ponti with Porcelain Shade

Lamp: 50W max. PAR16, GU10 base



LIR400-S

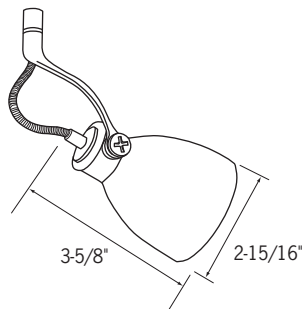

Radia-S with Porcelain Shade

Lamp: 40W max. T4, G9 Bi-pin base



LIR44156-S

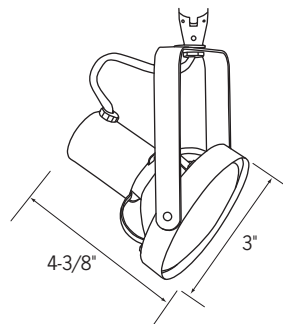

PAR20 Gimbal Mounted Spot

Front loading lamp, Sure-Set yoke
Lamp: 50W max. PAR20
E26 med. base



LIR2820-S