

LVR316R-SA

StopAire Low Voltage Recessed Remodel Downlight; Housing Only

Specifications/Features

Housing/Mounting

Low silhouette design for remodeling applications in solid or suspended ceilings.

Narrow fixture design for fast installation through ceiling opening minimizes remodeling mess.

Retractable mounting clips allow easy installation into existing ceiling.

Fixture is easily installed through ceiling opening.

Retractable mounting clips lock fixture in place and adjust for different ceiling thicknesses from 1/2" to 1".



Lamp/Electrical

(1) 10W Max. or (1) 50W Max., 12V MR16, GU5.3 base.

Class H "in-line" magnetic transformer is prewired and thermally protected. 120V in/12V out. Conveniently mounted to end of J-Box and is replaceable to simplify future maintenance.

(6) 1/2" knock outs and spring latch access plates in J-box.

Lamp housing is removeable through ceiling aperture for access to J-Box.

Can be used with low voltage, magnetic dimming controls for optimal control of illumination.

Ceramic terminal block socket.

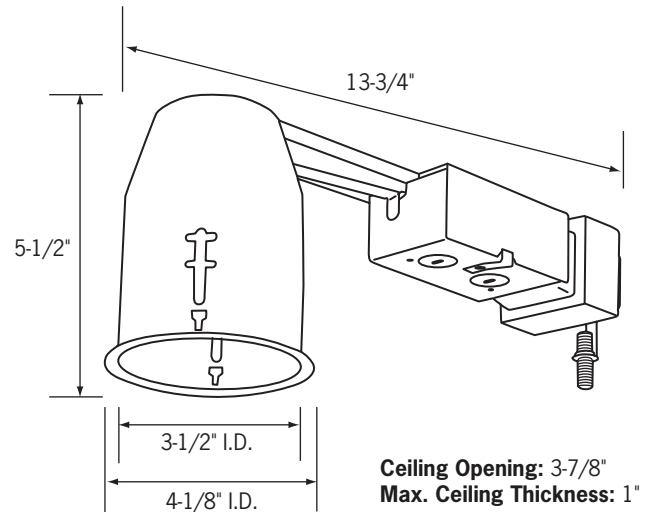

Trims

Baffle, multiplier, wall wash, accent and adjustable trim options available to suit a broad range of applications. See "Trims for 3" Low Voltage Recessed Housings" spec sheet for details.

Warranty

This fixture is covered by ConTech's full one (1) year replacement guarantee after date of purchase.

Labels/Usage

cCSAus Certified. Suitable for damp locations.

Conforms to Washington State Energy Code (WSEC) for low air filtration.

Tested in accordance with ASTM E283 (2.0 CFM or less).

Ordering Information

Example Order:

Housing/Voltage

LVR316R-SA 10M - 120V/12V/10W
LVR316R-SA - 120V/12V/50W

Trims

For Trims, see "Trims for 3" Low Voltage Recessed Housings" spec sheet.

Trims for 3" Low Voltage Recessed Housings

- All CTR3 Series Trims are cCSAus Certified and Suitable for Damp Locations; only Shower Trims are Wet Location Listed
- All Trims have White Trim finish unless specified
- For Trims designed for use with MR16 Lamps, ConTech Lighting provides a clear, Tempered Safety Glass Lens that should only be

used with open MR16 Lamps; not with MR16 Lamps that contain an integral Glass Lens

- If use of MR16 with Front Glass is required, remove the factory provided Safety Lens; Lens should also be removed when using MR16 LED Lamps
- Consult factory for LED Lamp compatibility

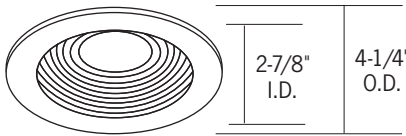

CTR301 Series
Adjustable Baffle

15° Vertical swing, 45mm lens. Trim can hold up to two (2) lenses with stepped lens holder (included). Insert 45mm lens on lower level of lamp seat, insert 50mm lens onto higher level.

CTR301-WHT - Adjustable White Baffle



CTR303N Series
Slotted Wall Wash

Internal 50° swing adjustment (25° from Nadir), external 358° rotation. Slot aperture permits maximum beam area adjustment for either wall wash or concealed accent lighting effects. Black interior surface.

CTR303N-P - White Slotted Wall Wash

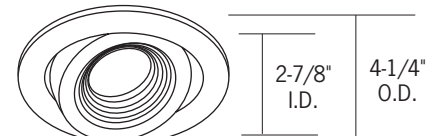

CTR307 Series
Adjustable Pin Spot

Deep baffle for maximum lamp concealment. May be used as a pin spot style downlight or an adjustable accent light. 35° Vertical adjustment. 45mm Lens. Trim can hold up to two (2) lenses with stepped lens holder (included). Insert 45mm lens on lower level of lamp seat, insert 50mm lens onto higher level.

CTR307-B - Black Baffle, Black Trim



CTR302 Series
Adjustable Multiplier

37° Vertical adjustment, 45mm lens. Trim can hold up to two (2) lenses with stepped lens holder (included). Insert 45mm lens on lower level of lamp seat, insert 50mm lens onto higher level.

- CTR302-B-BLKN** - Black Reflector, Black Trim
- CTR302-P-CLR** - Clear Reflector, White Trim
- CTR302-P-BLK** - Black Reflector, White Trim
- CTR302-P-WHT** - White Reflector, White Trim
- CTR302STCLR** - Clear Reflector, Brushed Stainless Steel Trim

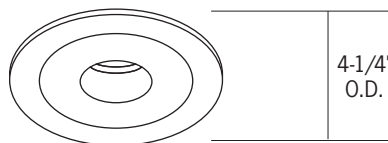

CTR305 Series
Pin Spot

Downlight Only, 50mm Lens. Trim can hold up to two (2) lenses with stepped lens holder (included). Insert 45mm lens on lower level of lamp seat, insert 50mm lens onto higher level.

CTR305-CLR - Clear Cut-Off Reflector, White Trim

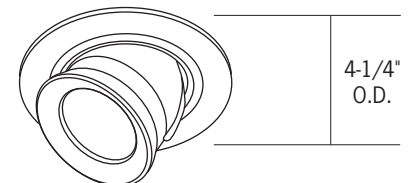

CTR325 Series
Fully Adjustable

Die cast, fully adjustable, round lampholder and backplate. Easy relamping with twist-off front retaining ring. Unsurpassed aiming flexibility: 87° vertical, 359° rotational. 50mm lens.

CTR325-B - Black
CTR325-P - White

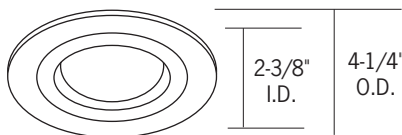

CTR312
Flat Glass

Etched Glass for light diffusion.

CTR312-P - Flat Glass, White Trim



CTR311FR
Frosted Flat Glass Shower Light

Shower light trim, double neoprene gasketed. cULus Listed for wet location.

CTR311FR-P - Frosted Flat Glass Shower Light, White Trim

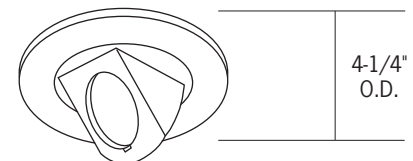

CTR324 Series
Fully Adjustable

Unsurpassed aiming flexibility: 87° vertical, 359° rotational. Front access, spring latch lamp retainer ring, black finish (optional white retainer ring available: **1623/24 WHITE**, ordered separately). Exclusive stainless flat springs insure firm, close-to-ceiling mounting. Accepts only one 47mm lens; if louver is required (**FA-16 45MM**), remove safety lens and use front glass MR16 lamp.

CTR324-P - White