

# PPRO SERIES | Precedent Pro Modular Linear Lighting

Precedent Pro Modular Linear Lighting delivers premium performance for suspended environments. The three (3) TIR Optic options provide varied distributions with superior beam control and lighting uniformity for both vertical and horizontal planes. The Stack optic creates an ideal solution for retail aisles, file rooms and library stacks while the Asymmetric and Flood optics serve other general applications.

- Quick-connect Wiring Harness (for power, dimming, and grounding) can support continuous runs up to 80 feet
- Three (3) available downlight outputs delivering up to 1700 lumens/linear foot and three (3) available up-light outputs for up to 600 lumens/linear foot
- Mechanical overlapping luminaire connections support simple installation and ensure a seamless line of illumination without light leaks
- Available in stand-alone or continuous run configurations

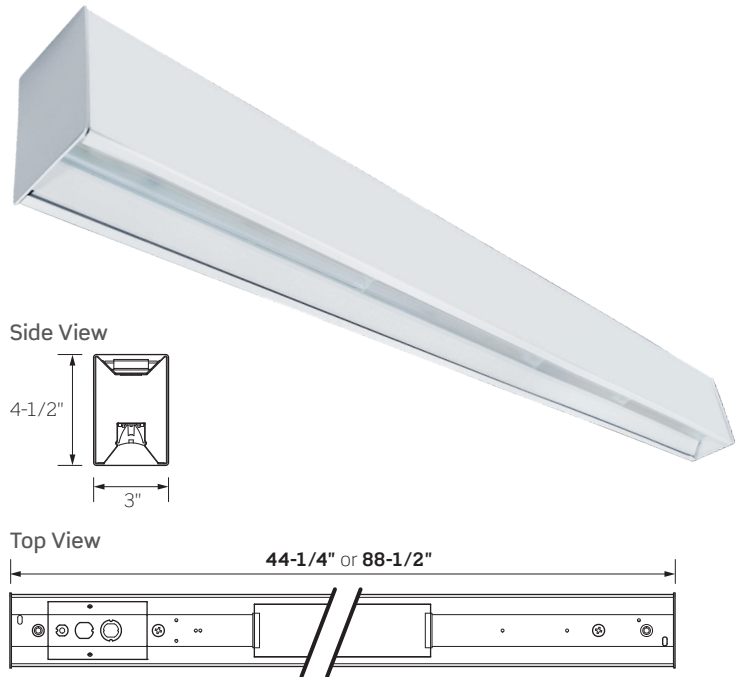

	PPRO4: 44-1/4" Linear			PPRO8: 88-1/2" Linear		
LED SERIES	04	10	15	04	10	15
WATTAGE	11.1W	29.8W	46.4W	22.2W	59.6W	92.8W
DELIVERED LUMENS <sup>1</sup>	1717Lm	4279Lm	6270Lm	3434Lm	8558Lm	12540Lm
LUMEN/WATT	154.7Lm/W	143.6Lm/W	135.1Lm/W	154.7Lm/W	143.6Lm/W	135.1Lm/W
UPLIGHTING DELIVERED LUMENS PER LUMINAIRE	No Uplighting/1100Lm/1600Lm/2500Lm			No Uplighting/2200Lm/3200Lm/4900Lm		

1. Performance based on 4000K/83CRI Flood Beam Optic; see Photometric Test Results and Multiplier Guides for additional information. Please refer to Photometric Test Results and Multiplier Guides for alternate Optic or Color Temperature/CRI options

## PRODUCT SPECIFICATIONS

### CONSTRUCTION

- Die Formed and Spot Welded Cold Rolled Steel Construction
- Powder Coat Paint Finish in White, Black or Silver
- Available in **44-1/4-inches** (PPRO4) and **88-1/2-inches** (PPRO8) lengths
- Can be specified as a Stand Alone unit or in Continuous Runs up to 80 feet
- Manufactured in North America

### PERFORMANCE

- TIR Molded Optics with Stack, Asymmetric and Flood distributions deliver uniformity and intensity on both horizontal and vertical target planes
- Optional factory installed Horizontal Louver
- 3000K, 3500K and 4000K CCT with a CRI 80+ or 90+
- L80 Performance > 50,000 hours

### ELECTRICAL

- 120-277V 50/60Hz 0-10V Dimming down to 1%
- Single- or Two-Circuit wiring options allow independent control of the optional up light or EM Unit control in continuous runs
- Optional integrated 10W, 90-minute Battery Back-up Module with Test Switch

### INSTALLATION

- Available adjustable Aircraft Cable Suspension Kits and Power Feeds allow up to 20-foot suspension
- Certified for installation within ambient temperatures up to 42°C (107.6°F)

### CERTIFICATIONS AND WARRANTY

- cETLus certified for use in U.S. and Canada
- Suitable for Damp Locations
- Five (5) year replacement after date of purchase

# PPRO SERIES | Precedent Pro

## Modular Linear Lighting

### ORDERING INFORMATION FOR SERIES LINL1 FAMILY

Example Order: PPRO840K0015FMVD2SAEM-P-2C

Length <sup>2</sup>	CCT/CRI	Uplight <sup>3</sup>	Downlight <sup>3</sup>	Distribution	Driver	Unit Type	Battery Backup	Finish	Options
<b>PPRO4</b> 44-1/4"	80+ CRI	<b>00</b> No Output	<b>04</b> 460Lm/ Linear Ft.	<b>S</b> Stack	<b>MVD2</b> 120 - 277V 0-10V Dim.	<b>SA</b> Stand Alone	No Backup, Leave Blank	<b>P</b> White	<b>2C</b> Two-Circuit Wiring
	<b>30K</b> 3000K	<b>02</b> 307Lm/ Linear Ft.	<b>F</b> Flood	<b>10</b> 1156Lm/ Linear Ft.					
<b>PPRO8</b> 88-1/2"	4000K	<b>04</b> 435Lm/ Linear Ft.	<b>15</b> 1700Lm/ Linear Ft.		<b>MR</b> Middle of Run	<b>ER</b> End of Run		<b>S<sup>4</sup></b> Silver	<b>L43</b> Black Louver
	90+ CRI	<b>06</b> 669Lm/ Linear Ft.							
	<b>30KC</b> 3000K								
	<b>35KC</b> 3500K								<b>L44</b> Silver Louver
	<b>40KC</b> 4000K								

- Precedent Pro is available in 44-1/4" or 88-1/2" bodies; please note unit lengths when creating continuous inter-connected runs
- Output options represent Delivered Lumens per Linear Foot of lighting using a flood optic at 4000K/80CRI; actual outputs vary by Optic and CCT/CRI; refer to Photometric Test Results and Multiplier Guides as necessary
- White is the Standard Finish; Black and Silver finishes available, consult factory for lead time

### SUSPENSION & POWER FEED KITS

Suspension and Power Feed Kits include a length of field cut-table Aircraft Cable and Canopy Kit

Kit Type	Drop Length	Finish
<b>PPROAC</b> Suspension Kit	<b>48</b> 48"/4 Ft.	<b>P</b> White
<b>PPROPF5WAC</b> 5-Wire Power Feed Kit	<b>120</b> 120"/10 Ft.	<b>B<sup>4</sup></b> Black
<b>PPROPF6WAC</b> 6-Wire Power Feed Kit	<b>240</b> 240"/20 Ft.	<b>S<sup>4</sup></b> Silver

- White is the Standard Finish; Black and Silver finishes available, consult factory for lead time

### EXAMPLE BILL OF MATERIAL: AISLE

One (1) 59 Foot Continuous Run: 4000K/80CRI, Flood Optic, No Uplighting, Series 15 Downlighting, 120/277V, 0-10V Dimming

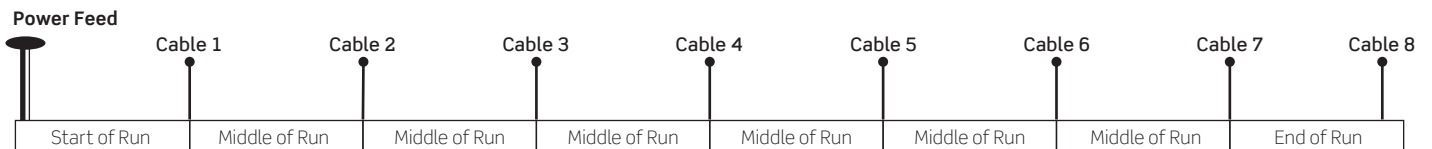

BILL OF MATERIAL	
<b>Luminaires:</b>	One (1) PPRO830K0615SMVD2SR-P Six (6) PPRO830K0615SMVD2MR-P One (1) PPRO830K0615SMVD2ER-P
<b>Power Feed:</b>	One (1) PPROPF5WAC48-P
<b>Supports:</b>	Eight (8) PPROAC48-P

RUN SUMMARY	
<b>59 Total Linear Feet:</b>	Eight (8) Luminaires x 88-1/2-inches = 708-inches/59 Feet
<b>Downlight:</b>	100,320 Total Delivered Lumens
<b>Lumens/Foot:</b>	1700 Delivered Lumens/Foot (100,320 Lumens / 59 Linear Feet)
<b>Total Watts:</b>	744W (Eight [8] Luminaires x 93W/Luminaire)
<b>Watts/Foot:</b>	12.6W/Linear Foot (744 Total Watts / 59 Linear Feet)

# PPRO SERIES | Precedent Pro Modular Linear Lighting

## PHOTOMETRICS: DOWN LIGHTS

### PPRO440K0015SMVD2SA: 44-1/4-Inch Luminaire / 4000K / LED Series 15 / Stack Optic

LM-63 Test No. G005948; LM-79 Test No. S23101801

Fixture Delivered Lumens: 6103.5  
Total Watts@120V: 46.4  
Lumens Per Watt: 131.5  
Center Beam Candle Power: 4965.9  
Beam Distribution: 52.3° @ 90°  
Spacing Criterion: 1.06 @ 90°  
Color Rendering Index (CRI)1: 81  
Color Temperature (CCT)2: 4000K

DISTANCE (FT.)	FOOTCANDLES (FC)	BEAM DIA. (FT.)
6 FT	99.8	5.9
8 FT	56.1	7.9
10 FT	35.9	9.8
12 FT	24.9	11.8
14 FT	18.3	13.8
16 FT	14.0	15.7

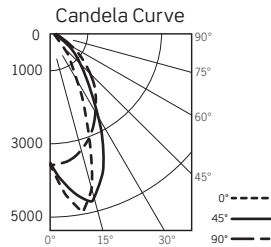

### PPRO440K0015FMVD2SA: 44-1/4-Inch Luminaire / 4000K / LED Series 15 / Flood Optic

LM-63 Test No. G005962; LM-79 Test No. S23101801

Fixture Delivered Lumens: 6269.9  
Total Watts@120V: 46.4  
Lumens Per Watt: 135.1  
Center Beam Candle Power: 3469.1  
Beam Distribution: 73.6° @ 90°  
Spacing Criterion: 1.17 @ 90°  
Color Rendering Index (CRI)1: 81  
Color Temperature (CCT)2: 4000K

DISTANCE (FT.)	FOOTCANDLES (FC)	BEAM DIA. (FT.)
6 FT	82.3	9.0
8 FT	46.3	12.0
10 FT	29.6	15.0
12 FT	20.6	18.0
14 FT	15.1	21.0
16 FT	11.6	23.9

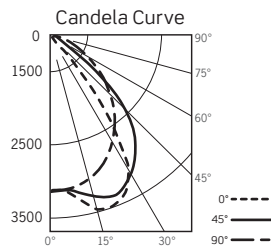

### PPRO440K0015AMVD2SA: 44-1/4-Inch Luminaire / 4000K / LED Series 15 / Asymmetric Optic

LM-63 Test No. G005950; LM-79 Test No. S23101801

Fixture Delivered Lumens: 5917.9  
Total Watts@120V: 46.4  
Lumens Per Watt: 127.5  
Center Beam Candle Power: 6486.5  
Beam Distribution: 57.5° @ 90°  
Spacing Criterion: 1.12 @ 90°  
Color Rendering Index (CRI)1: 81  
Color Temperature (CCT)2: 4000K

DISTANCE (FT.)	FOOTCANDLES (FC)	BEAM DIA. (FT.)
6 FT	73.5	7.0
8 FT	41.3	9.3
10 FT	26.5	11.6
12 FT	18.4	13.9
14 FT	13.5	16.2
16 FT	10.3	18.5

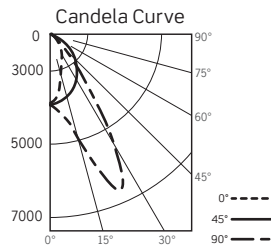

1. Accuracy of Rendering Colors
2. Color Appearance of Light Source
3. Dependent on Surrounding Temperatures
4. Colors Present within the Light Source

## PHOTOMETRIC MULTIPLIERS: FOR DOWNLIGHT ONLY

Lumen output values fluctuate based on Color Temperature (CCT), Color Rendering Index (CRI) and Wattage. Published performance data is based on 4000K, 80CRI and the highest wattage series available.

To estimate lumen output of other combinations, multiply the published results by the following factors:

CCT MULTIPLIERS			OUTPUT MULTIPLIERS		
CCT	80/STD CRI	90/HIGH CRI	SERIES 04	SERIES 10	SERIES 15
3000K	0.961	0.822	0.27	0.68	1.00
3500K	0.975	0.849			
4000K	1.000	0.877			

# PPRO SERIES | Precedent Pro

## Modular Linear Lighting

### PHOTOMETRICS: UP LIGHT

#### PPRO440K06: 44-1/4-Inch Luminaire / 4000K / LED Series 06 / Up Light Only

LM-63 Test No. G005199.001; LM-79 Test No. S23101801

Fixture Delivered Lumens: 2468  
 Total Watts@120V: 15.4  
 Lumens Per Watt: 160  
 Center Beam Candle Power: 893  
 Beam Distribution: 79°  
 Color Rendering Index (CRI)1: 81  
 Color Temperature (CCT)2: 4000K

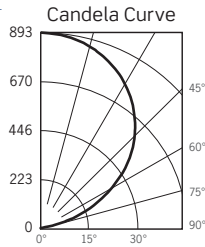

1. Accuracy of Rendering Colors 2. Color Appearance of Light Source 3. Dependent on Surrounding Temperatures

### PHOTOMETRIC MULTIPLIERS: FOR UP LIGHT ONLY

Lumen output values fluctuate based on Color Temperature (CCT), Color Rendering Index (CRI) and Wattage. Published performance data is based on 4000K, 80CRI and the highest wattage series available. To estimate lumen output of other combinations, multiply the published results by the following factors:

CCT	CCT MULTIPLIERS		OUTPUT MULTIPLIERS		
	80/STD CRI	90/HIGH CRI	SERIES 02	SERIES 04	SERIES 06
3000K	0.961	0.822	0.46	0.65	1.00
3500K	0.975	0.849			
4000K	1.000	0.877			

#### TM-30 DATA PPRO435K0615SMVD2SR: 44-1/4-Inch Luminaire / 3500K / LED Series 15 / Stack Optic

ANSI/IES TM-30-18 Color Rendition Report Test No. S23101801

Colors are for visual orientation purposes only

Rf	84
Rg	96
CCT(K)	3485K
Duv	-0.0007
ul	0.2364
vl	0.5107

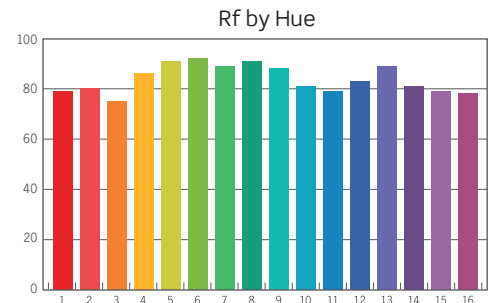
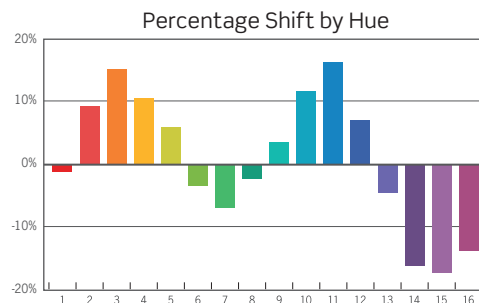
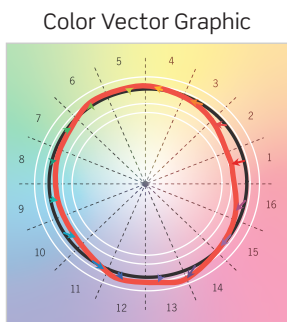
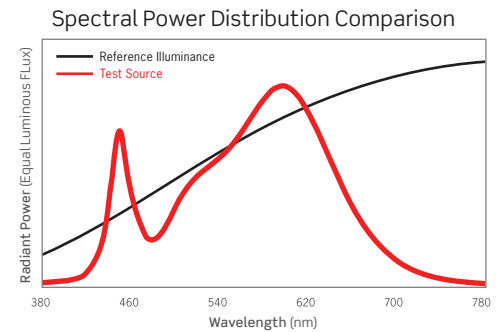
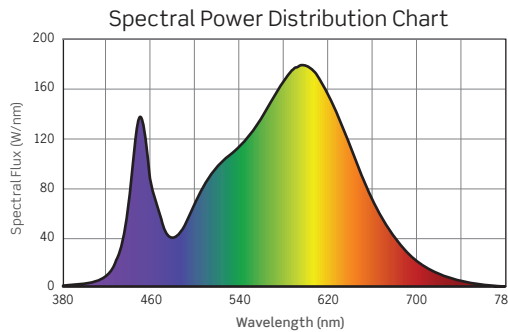

HUE BIN	1	2	3	4	5	6	7	8	9	10	11	12	13	14	15	16
HUE SHIFT	-1%	8%	13%	9%	5%	-3%	-6%	-2%	3%	10%	14%	6%	-4%	-14%	-15%	-12%
R <sub>f</sub> VALUE	79	80	75	86	91	92	89	91	88	81	79	83	89	81	79	78