

DATE

PROJECT



TYPE

R6W SERIES | 6-In Recessed Pull Down Wall Lighter: R6WIC Insulated Ceiling (IC)/StopAire™ Housing

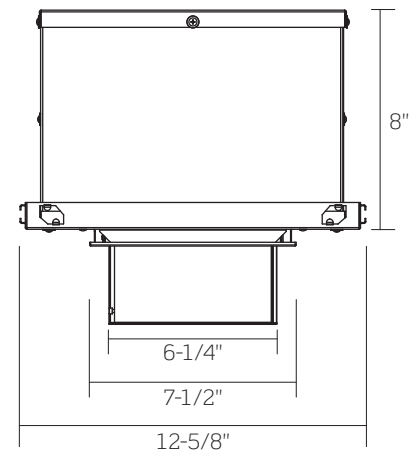
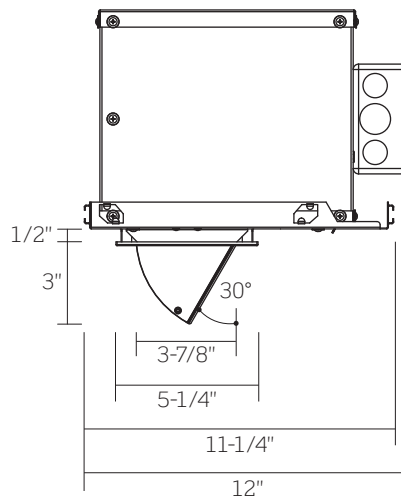

Ceiling Opening: 4-7/8" by 7-1/4"
Ceiling Thickness: 1/2" - 1-1/2"



	R6WIC1	R6WIC2
WATTAGE	21W	28W
LUMEN OUTPUT ¹	2400Lm	3200Lm
COLOR TEMPERATURE	2700K / 3000K / 3500K / 4000K	
CRI	83 (80min) / 90+	
INPUT WATTAGE	21W	28W
INPUT CURRENT (A) 120V/277V	.18/.08	.24/.10
INPUT VOLTAGE	120VAC / 277VAC , 50/60Hz	
Standard Driver (TRIAC, ELV, 0-10V)	120VAC / 277VAC , 50/60Hz	
Lutron Eco-System® Driver	120VAC / 277VAC , 50/60Hz	
eldoLED ECOdrive and SOLOdrive	120VAC / 277VAC , 50/60Hz	
DRIVER POWER FACTOR	> 0.90	
TOTAL HARMONIC DISTORTION (THD)	< 20%	
LISTINGS	cCSAus Certified to UL Standards; suitable for Damp locations Compliant with ASTM E283 (Air Leakage Rate 2.0 CFM or less) ENERGY STAR® Certified; eldoLED Dimming Options are not ENERGY STAR® Certified	
	 	
WARRANTY	Five (5) year replacement after date of purchase	
SYSTEM RATING	50,000 Hours @ 70% Lumen Maintenance	

1. Lumen values are approximate, see photometric test results

DATE	PROJECT	TYPE
------	---------	------

R6W SERIES | 6-In Recessed Pull Down Wall Lighter: R6WIC Insulated Ceiling (IC)/StopAire™ Housing

ORDERING INFORMATION

Example Order: -

Housing/LED Series	Color Temp/CRI	Electrical/Dimming	Finish
R6WIC1 - 21W, 2400lm	83 (80min) CRI	MVD¹ - 120-277V TRIAC, ELV, 0-10V	B - Black
R6WIC2 - 28W, 3200lm	27K - 2700K	MVD4 - Lutron Hi-lume 1% EcoSystem LED Driver with Soft-on, Fade-to-Black	P - White
	30K - 3000K	MVD6 - 120-277V eldoLED ECOdrive, 0-10V, 1% Dimming	
	35K - 3500K	MVD7 - 120-277V eldoLED ECOdrive, DALI, 1% Dimming	
	40K - 4000K	MVD8 - 120-277V eldoLED SOLOdrive, 0-10V, 0.1% Dimming	
	90+ CRI	MVD9 - 120-277V eldoLED SOLOdrive, DALI, 0.1% Dimming	
	27KC - 2700K		
	30KC - 3000K		
	35KC - 3500K		
	40KC - 4000K		

1. TRIAC and ELV Dimming for 120V only

Accessories

Standard Hanger Bars Supplied with Housing

HB-30 - T-Bar Hanger Set

Additional Accessories on Page 3

DATE

PROJECT

TYPE

R6W SERIES | Stealth Pull Down Wall Lighter Accessories

Accessory Holder

5-3/8" W, 3" H, 5/8" D

Will accept up to two (2) LF49 Lenses or FA-54 Louvers.

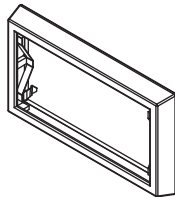

Snoot

4-5/8" W, 2-1/4" H, 1/2" D

Requires FA-19 Accessory Holder. For White (-P) finish, the inside surface is black.

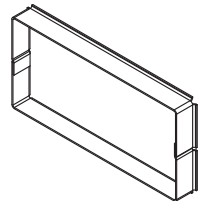

FA-19 - Accessory Holder

Finish

B - Black
P - White

Quantity

FA-53 - Snoot

Finish

B - Black
P - White

Quantity

Honeycomb Louver

4-3/4" L x 2-15/16" H x 1/8" D

Glare control and shielding accessory. Requires FA-19 Accessory Holder. Black finish.

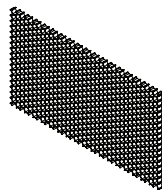

FA-54 - Honeycomb Louver

Quantity

Tempered Glass Lenses

4-3/4" L x 2-15/16" H x 1/8" D

Requires FA-19 Accessory Holder

LF49 - Tempered Glass Lenses

Finish

73 - Spread Lens
LSH - Linear Spread Lens, Horizontal
Elongates beams horizontally
LSV - Linear Spread Lens, Vertical
Elongates beams vertically
SL - Soft Light
SOL - Solite
UV - Optivex UV Filter

A - Amber
B - Blue
CL - Clear
DPE - Dichroic Peach
G - Green
LB - Light Blue
R - Red
RO - Rose
Y - Yellow

Quantity

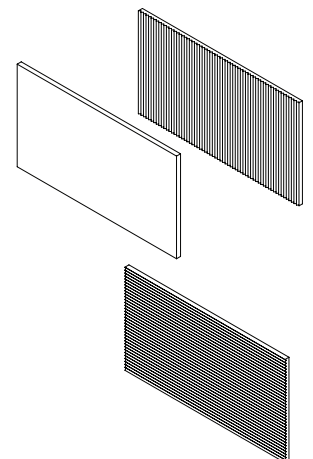

DATE

PROJECT

TYPE

R6W SERIES | 6-In Recessed Pull Down Wall Lighter: R6WIC Insulated Ceiling (IC)/StopAire™ Housing

PRODUCT DETAILS

Construction

- Specification Grade 6-inch 16 Gauge Galvanized Steel Insulated Ceiling (IC)/StopAire™ Housing; Die-Cast Aluminum Pull-down Head and Trim Frame
- Housing can be used in direct contact with insulation materials
- Unique Heat Pipe/Radiator Finned Heat Sink provides exceptional heat dissipation, ensuring long life and consistent performance
- Constant tension Pull-down Head with vertical adjustment from 0° to 60° for aiming ease
- Locking mechanism with graduations for consistent fixture-to-fixture aiming
- Quick Connect Light Engine enables easy installation and removal
- Drivers are fully accessible from below the ceiling and can be easily removed
- Dual Nailer Hanger Bars are adjustable for 16- and 24- inch center joists (14-1/4- to 24-1/2- inch). Nailer Bars may be extended to rest on T-Bar ceilings; optional clip-on T-Bar Hangers available.
- Pre-wired Junction Box with eight (8) 1/2- inch and four (4) 3/4- inch Knockouts
- Output over-voltage, over-current and short circuit protection
- Approved for Through Circuit Wiring: max. eight (8) 12 AWG (4in/4out), wiring rated for at least 90°C
- Will accept up to two (2) LF49 Lenses, FA-54 Louvers or one (1) FA-53 Snoot by using the FA-19 Accessory Holder
- For accessory ordering information, see page 3

Performance Summary

- 2700K, 3000K, 3500K and 4000K Color Temperatures; 80 CRI min., 83 typical; high CRI of 90+ available
- Excellent fixture-to-fixture color consistency with a 3-step MacAdam Ellipse tolerance
- All R6W Wall Lighter Downlights are available for non-dimming and dimming applications; for compatible Dimmers, refer to the Dimming Specification Sheet
- UL8750 and Class 2 Compliant; RoHS Compliant, US only
- Assembled in the USA

DATE

PROJECT

TYPE

R6W SERIES | 6-Inch Pull Down Wall Lighter: R6W

PHOTOMETRICS: R6W - SERIES-6, 3000K Standard (83) CRI

Color Rendering Index (CRI)¹: 82
Color Temperature (CCT)²: 3164K
Designed for 50,000 Hour Lamp Life³
LM-79 Test: 524102101

Spectral Power Distribution Chart⁴

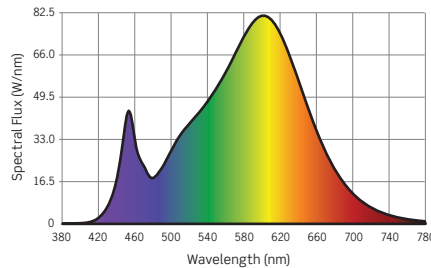

LED SERIES	TOTAL W @ 120V	DELIVERED LMS	LM/WATT	LM-63 TEST
R6WIC1 20W/SERIES 1	20.9W	2462Lm	117.8	G24102201
R6WIC2 28W/SERIES 2	28.4W	3261Lm	114.4	G24102202

1. Accuracy of Rendering Colors 2. Color Appearance of Light Source 3. Dependent on Surrounding Temperatures 4. Colors Present within the Light Source

PHOTOMETRIC MULTIPLICATION FACTORS

Lumen output values fluctuate based on wattage, CCT and CRI. To estimate lumen output of the various options, multiply 3000K, Standard CRI results using the following:

LED SERIES	MULTIPLIER
R6W - 21W / SERIES 1	0.43
R6W - 28W / SERIES 2	0.57
R6W - 36W / SERIES 3	0.70
R6W - 43W / SERIES 4	0.79
R6W - 50W / SERIES 5	0.90
R6W - 58W / SERIES 6	1.00

CCT MULTIPLIERS		
CCT	STD CRI (83)	HIGH CRI (90+)
2700K	0.95	0.74
3000K	N/A	0.85
3500K	1.03	0.89
4000K	1.07	0.92

DATE

PROJECT









TYPE

R6W SERIES | 6-Inch Pull Down Wall Lighter: R6W









PHOTOMETRICS: R6W - SERIES-6, 3000K Standard (83) CRI

Note: All data below is based on Series-6, 3000K Standard (83) CRI. Please use multiplication factors below for alternate output and LED options.

Mounted 3 Feet From Wall, 10' Mounting Height, Tilted 40 Degrees from Nadir is beam center

Distance from Ceiling	Single Unit						Multiple Units								
	0 FT	1 FT	2 FT	3 FT	4 FT	5 FT	4 FT on Center			6 FT on Center			8 FT on Center		
															
1 FT	103	93	76	62	47	31	197	201	198	133	135	134	107	91	110
2 FT	94	84	69	58	44	28	183	188	184	125	127	125	100	86	102
3 FT	86	76	65	54	40	28	170	174	170	116	118	116	92	81	94
4 FT	75	71	60	49	40	28	152	157	153	105	107	105	83	75	86
5 FT	59	59	52	41	35	28	124	128	125	87	88	87	68	63	71
6 FT	43	43	40	33	27	23	96	100	97	69	70	69	54	52	55
7 FT	29	28	25	23	19	15	71	74	71	52	53	52	40	40	41
8 FT	24	24	22	19	17	15	59	62	60	44	45	44	34	34	35
9 FT	18	18	17	15	14	12	48	50	48	36	37	36	28	28	29

Mounted 4 Feet From Wall, 10' Mounting Height, Tilted 40 Degrees from Nadir is beam center

Distance from Ceiling	Single Unit						Multiple Units								
	0 FT	1 FT	2 FT	3 FT	4 FT	5 FT	4 FT on Center			6 FT on Center			8 FT on Center		
															
1 FT	64	62	60	47	35	25	143	146	143	101	101	101	79	75	79
2 FT	62	60	58	45	35	25	141	144	142	100	100	100	78	75	78
3 FT	60	59	56	45	35	25	139	142	140	99	99	99	77	74	77
4 FT	57	55	54	45	35	25	134	136	135	95	96	95	75	72	74
5 FT	49	48	46	42	33	23	118	121	120	86	86	85	67	65	66
6 FT	41	40	39	34	30	21	103	106	104	75	76	75	59	58	58
7 FT	33	33	32	28	23	19	89	91	89	65	67	65	51	51	51
8 FT	28	27	27	25	21	16	76	78	77	57	58	57	45	44	44
9 FT	22	22	22	20	18	14	62	65	64	48	49	48	38	38	38

PHOTOMETRIC MULTIPLICATION FACTORS

Lumen output values fluctuate based on wattage, CCT and CRI. To estimate lumen output of the various options, multiply 3000K, Standard CRI results using the following:

LED SERIES	MULTIPLIER
R6W - 21W / SERIES 1	0.43
R6W - 28W / SERIES 2	0.57
R6W - 36W / SERIES 3	0.70
R6W - 43W / SERIES 4	0.79
R6W - 50W / SERIES 5	0.90
R6W - 58W / SERIES 6	1.00

CCT MULTIPLIERS		
CCT	STD CRI (83)	HIGH CRI (90+)
2700K	0.95	0.74
3000K	N/A	0.85
3500K	1.03	0.89
4000K	1.07	0.92

DATE

PROJECT

TYPE

R6W SERIES | 6-Inch Recessed Pull-Down Wall Lighters: Dimming Specifications

- Incandescent 120VAC Dimmers adjust the light with “forward phase control,” where the dimmer “chops” the forward part of the AC Wave to deliver less or more power to the light source. No neutral wire connection required.
- Electronic Low Voltage 120VAC Dimmers adjust the light with “reverse phase control,” where the dimmer “chops” the back part of the AC Wave to deliver less or more power to the light source. Neutral wire connection required.
- 0-10V DC Low Voltage Dimmers operate using two (2) low voltage dimming wires that are separate from the 120V or 277V AC power. The dimmer sends a variable output voltage to the fixture based upon the dimming level. 10V Corresponds to undimmed operation, 5V to 50% and so on. Switching on/off is controlled with the line voltage power (120V or 277V AC) input to the dimmer and then dimming operation is controlled with the 0-10V DC low voltage wiring connection between the Dimmer and the LED Driver. The control signal runs on two (2) low voltage control wires (color coded Purple and Pink/Grey).
- Lutron HiLume and EcoSystem Drivers provide continuous dimming from 1%-100%; for a complete list of compatible Dimmers and Controls, visit www.lutron.com
- Use DALI approved controls for dimming eldoLED MVD7 (1%-100%) and MVD9 (0.1%-100%) options.

			TRIAC, ELV, 0-10V DIMMING (12D, 27D or MVD Option*)	eldoLED ECOdrive 0-10V (12D6, 27D6 or MVD6 Option)	eldoLED SOLOdrive 0-10V (12D8, 27D8 or MVD8 Option)
Manufacturer	Product	Model	Light Output	Light Output	Light Output
Leviton	IllumaTech	IPI06-1LZ	2%-100%	NA	NA
Leviton	SureSlide	6631-2	1%-100%	NA	NA
Leviton	Vizia	VPE06	12%-100%	NA	NA
Leviton	Trimatron	6683-IW	8%-100%	NA	NA
Leviton	Decora	6161	20%-100%	NA	NA
Leviton	SureSlide	6633-P	3%-100%	NA	NA
Leviton	IllumaTech	IPE04	7%-100%	NA	NA
Leviton	IllumaTech	IP710-DLX	NA	1%-100%	0.1%-100%
Pass & Seymour	Titan	CD4FB-W	NA	1%-100%	0.1%-100%
Synergy		ISD BC	NA	1%-100%	0.1%-100%
Watt Stopper	Miro Decorator	DCLV1	NA	1%-100%	0.1%-100%
Lutron	Ariadni	TGCL-153P	8%-100%	NA	NA
Lutron	Ariadni	TG-600P	15%-100%	NA	NA
Lutron	Diva	DVCL-153P	3%-100%	NA	NA
Lutron	Diva	DV600P	9%-100%	NA	NA
Lutron	Diva	DVELV303P	10%-100%	NA	NA
Lutron	Diva	DVTV	NA	1%-100%	0.1%-100%
Lutron	Faedra	FAELV500	15%-100%	NA	NA
Lutron	Lumea	LG600P	10%-100%	NA	NA
Lutron	Maestro	MAELV600	15%-100%	NA	NA
Lutron	Nova	NFTV	NA	1%-100%	0.1%-100%
Lutron	Nova T	NTFTV	NA	1%-100%	0.1%-100%
Lutron	Skylark	S-603PG	7%-96%	NA	NA
Lutron	Skylark	S600P	6%-100%	NA	NA
Lutron	Skylark	SELV300P	10%-100%	NA	NA
Lutron	Skylark	CT103P	12%-100%	NA	NA

*277V Triac Dimming is not available

NOTES

1. If light is measured, then the dimming range is based on light output. If light is not measured, then the dimming range is based on the percentage of output current.
2. Testing was performed with a single fixture connected to dimmer.
3. Testing has been performed on these dimmers, but this does not imply any warranty of compatibility.
4. Dimming performance can be influenced by different loads, as well as variations in dimmer switches within the same model.
5. Dimmer maximum load rating with LED may differ from published traditional source dimmer ratings. Consult manufacturer for maximum dimmer information.
6. Consult factory for additional dimming information.