

DATE

PROJECT

TYPE

SQL3 SERIES | 3-1/2 Inch Indoor/Outdoor Square Cylinders: Rigid Stem Pendant Mount

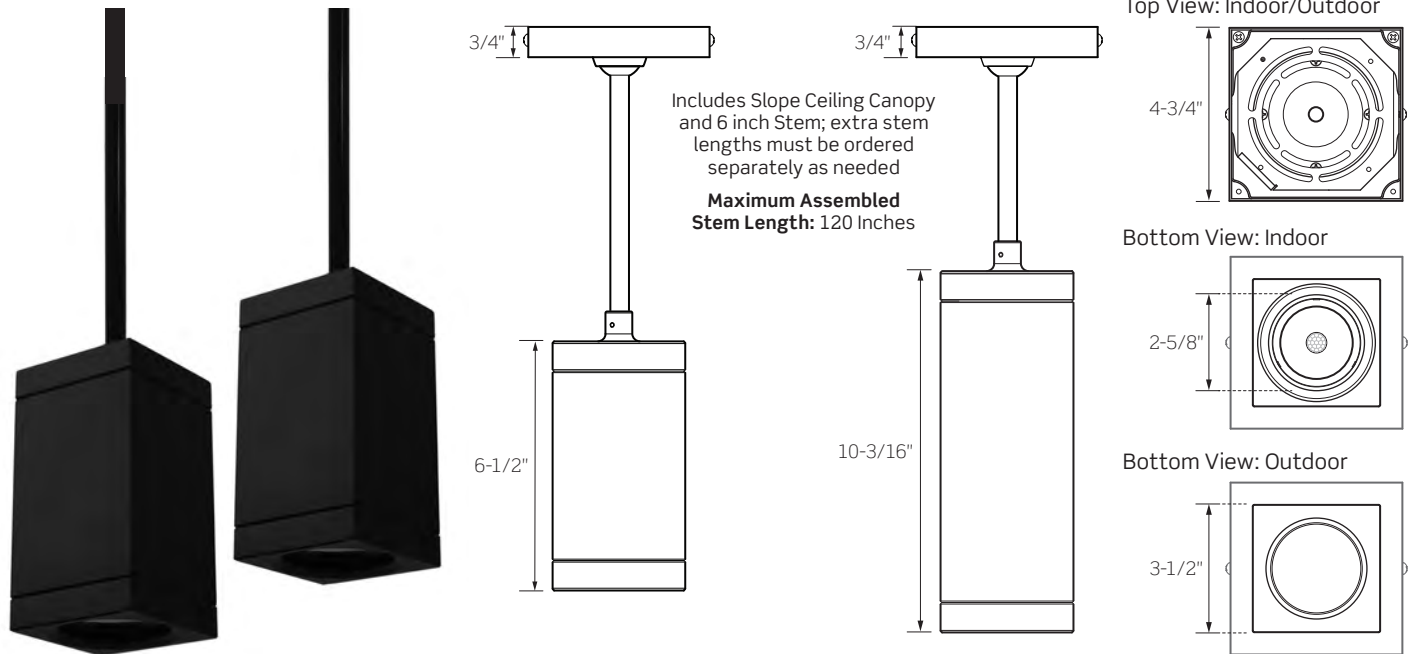

	SQL3S1/SQL3T1	SQL3S2/SQL3T2	SQL3S3/SQL3T3
WATTAGE	10W	14W	20W
LUMEN OUTPUT ¹	1100Lm	1400Lm	1800Lm
COLOR TEMPERATURE	2700K / 3000K / 3500K / 4000K		
CRI	83 (80min) / 90+		
BEAM	12° Spot / 28° Medium / 39° Flood / 65° Wide Flood / Wall Wash		
LUMINAIRE HEIGHT	6-1/2 Inches / 10-3/16 Inches		
FINISHES	Matte Black / Satin Bronze / Matte White / Matte Silver / Custom Colors Available		
DRIVER INPUT WATTAGE	10W	14W	20W
DRIVER INPUT VOLTAGE	120V – 277V Dimming, 50/60Hz		
DIMMING TYPE	120V TRIAC/ELV 120V Forward Phase Only 120V – 277V 0-10V Lutron HiLume EcoSystem		
LISTINGS	cCSAus Certified for use in the U.S. and Canada; Suitable for Damp/Dry or Wet locations ENERGY STAR® Certified Wet Location Cylinders feature a Silicone Sealed Clear Glass Lens in a Gasketed Die-Cast Trim Ring to ensure unit is watertight IP65 Rating for Wet Location Models Cylinders must be installed per specific product installation instructions and all appropriate NEC Codes		
WARRANTY	Five (5) year replacement after date of purchase		
SYSTEM RATING	50,000 Hours @ 70% Lumen Maintenance		

1. Approximate lumen output based on 3000K performance; see photometric test results for additional information

DATE

PROJECT

TYPE

SQL3 SERIES | 3-1/2 Inch Indoor/Outdoor Square Cylinders: Rigid Stem Pendant Mount

ORDERING INFORMATION

Example Order: - -

Cyl. Height	LED Series	Color Temp/CRI	Driver/Dimming	Mounting	Mntg Location	Beam
SQL3S ¹ - 6-1/2 In.	1 - 10W 1100lm	83 (80min) CRI 27K - 2700K 30K - 3000K 35K - 3500K 40K - 4000K	12D1 - 120V TRIAC/ELV 12D3 ² - Lutron HiLume 1%, 2-Wire LED Driver (120V Forward Phase Only)	RS ³ - Rigid Stem Pendant	- Interior Dry/Damp Locations, Leave Blank	S - 12° Spot M - 28° Medium F - 36° Flood WF - 65° Wide Flood
SQL3T - 10-3/16 In.	2 - 14W 1400lm 3 - 20W 1800lm	90+ CRI 27KC - 2700K 30KC - 3000K 35KC - 3500K 40KC - 4000K	MVD2 - 120V-277V 0-10V Dimming MVD4 ² - Lutron HiLume 1%, EcoSystem LED Driver Soft-On, Fade-to-Black		X - Exterior Wet Locations	WW ⁴ - Wall Wash

Finish

- B** - Matte Black
- BZ** - Satin Bronze
- P** - Matte White
- S** - Matte Silver
- CC**⁵ - Custom Color

Battery and Remote Enclosure⁶

- None, Leave Blank
- RDB** - Remote Driver & Battery Pack
- RD** - Remote Driver Enclosure

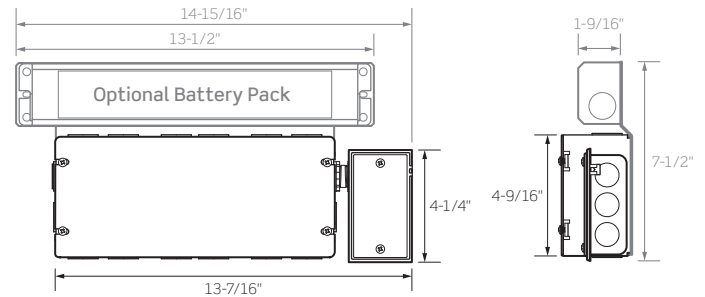

RDB: Remote Driver & Battery Pack
Battery Flexible Conduit Whips Not Pictured
RD: Remote Driver Enclosure

1. 10W Short Series (CY3S1) luminaires are not available with MVD2 Drivers
2. Lutron HiLume Drivers must use Remote Driver Enclosure (RD Option)
3. Rigid Stem Pendant Mount (RS) includes Slope Ceiling Canopy (up to 45°) and 6 Inch Stem; extra stem lengths must be ordered separately as needed. Maximum assembled stem length: 120 Inches/10 Feet
4. Wall Wash Optic (WW) is not field interchangeable with Spot, Medium, Flood or Wide Flood Optics
5. Custom Color finishes available; consult factory for pricing, minimum order quantities and lead time
6. RD and RDB Options must be installed in Dry/Damp Locations

RIGID STEM & ACCESSORY ORDERING INFORMATION

Stems for RS Mounting

- 6" STEM(A)** - 6 In Stem
- 12" STEM(A)** - 12 In Stem
- 18" STEM(A)** - 18 In Stem
- 24" STEM(A)** - 24 In Stem
- 30" STEM(A)** - 30 In Stem
- 36" STEM(A)** - 36 In Stem
- 48" STEM(A)** - 48 In Stem
- COUPLING** - Stem Coupling

Finish

- B** - Matte Black
- BZ** - Satin Bronze
- P** - Matte White
- S** - Matte Silver
- CC**⁵ - Custom Color

Replacement Optics

- 2INOPTIC-S** - 12° Spot
- 2INOPTIC-M** - 28° Medium
- 2INOPTIC-F** - 36° Flood
- 2INOPTIC-WF** - 65° Wide Flood

Spot (S), Medium (M), Flood (F), and Wide Flood (WF) Optics are not interchangeable with Wall Wash (WW) options

Accessories

- FA-47** - Accessory Holder
- FA-16 60MM** - 2-3/8 Inch Diameter Black Honeycomb Louver
Requires FA-47 Accessory Holder
- LF16-* 60MM** - 2-3/8 Inch Diameter Tempered Glass Lenses and Filters
1/8 Inch Thick, typical
Requires FA-47 Accessory Holder

*Color/Pattern Legend

- 73** (Spread Lens), **-LS** (Linear Spread Lens), **-SL** (Soft Light), **-SOL** (Solite), **-UV** (Optivex UV Filter), **-A** (Amber), **-B** (Blue), **-CL** (Clear), **-DPE** (Dichroic Peach), **-G** (Green), **-LB** (Light Blue), **-R** (Red), **-RO** (Rose), **-Y** (Yellow)

DATE

PROJECT

TYPE

SQL3 SERIES | 3-1/2 Inch Indoor/Outdoor Square Cylinders: Rigid Stem Pendant Mount

PRODUCT DETAILS

Construction

- Specification Grade 3-1/2 inch square Aluminum Housing for indoor and outdoor applications
- Cast Aluminum Driver Canopy
- Available in 6-1/2 and 10-3/16 inch heights
- Suitable for Dry/Damp (indoor) or Wet (outdoor) location types
- Wet Location Cylinders feature a Silicone Sealed Clear Glass Lens in a Gasketed Die-Cast Trim Ring to ensure unit is watertight
- Hang support for hands-free wiring
- Includes Slope Ceiling Canopy (up to 45°) and 6 inch Stem; extra stem lengths must be ordered separately as needed
- Maximum Assembled Stem Length: 120 Inches
- Stem thread: 1/4-18NPS

Performance Summary

- Available in 12° Spot, 28° Medium, 39° Flood and 65° Wide Flood Beam Distributions, as well as a Wall Wash option
- Wall Wash Optic may be rotated 360° to aim distribution pattern
- Optics have been optically engineered to provide a smooth uniform beam, maximizing output and minimizing glare
- Optics can be easily changed in the field for optimal flexibility; Wall Wash Optic (WW) is not field interchangeable with Spot, Medium, Flood or Wide Flood Optics
- 2700K, 3000K, 3500K and 4000K Color Temperatures; CRI 80 of min., 83 typical; high CRI 90+ available
- Excellent fixture-to-fixture color consistency within a 3-step MacAdam Ellipse tolerance
- Battery Backup option provides 90 minutes of power
- UL8750 and Class 2 compliant: RoHS compliant, U.S. only
- Output over voltage, over current and short circuit protected
- SQL3 Cylinders are available for non-dimming and dimming applications; for dimmer compatibility, refer to Dimming Specification sheet

DATE

PROJECT

TYPE

SQL3 SERIES | 3-1/2 Inch Indoor/Outdoor Square Cylinders

SQL3S330K12D1CS

Fixture Delivered Lumens: 1572.35
 Total Watts@120V: 20.5
 Lumens Per Watt: 76.7
 Center Beam Candle Power: 18447
 Beam Distribution: 12.3°
 Spacing Criterion: 0.24
 Color Rendering Index (CRI)¹: 83
 Color Temperature (CCT)²: 3107K
 Designed for 50,000 Hour Lamp Life³
 LM-63 Test No. G20012901
 LM-79 Test No. S20013101

Intensity Distribution

DISTANCE (FT.)	FOOTCANDLES (FC)	BEAM DIAMETER (FT.)
4'	1152.9	0.9
6'	512.4	1.3
8'	288.2	1.7
10'	184.5	2.2
12'	128.1	2.6
14'	94.1	3.0

Candela Curve

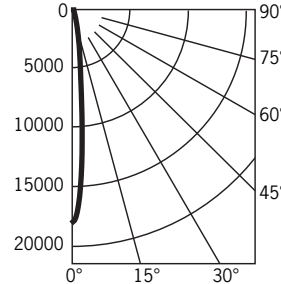

Spectral Power Distribution Chart⁴

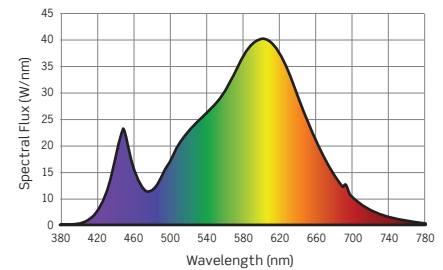

SQL3S330K12D1CM

Fixture Delivered Lumens: 2068.13
 Total Watts@120V: 20.5
 Lumens Per Watt: 100.9
 Center Beam Candle Power: 8383
 Beam Distribution: 28.7°
 Spacing Criterion: 0.47
 Color Rendering Index (CRI)¹: 83
 Color Temperature (CCT)²: 3107K
 Designed for 50,000 Hour Lamp Life³
 LM-63 Test No. G20012803
 LM-79 Test No. S20013101

Intensity Distribution

DISTANCE (FT.)	FOOTCANDLES (FC)	BEAM DIAMETER (FT.)
4'	523.9	2.1
6'	232.9	3.1
8'	131.0	4.1
10'	83.8	5.1
12'	58.2	6.1
14'	42.8	7.2

Candela Curve

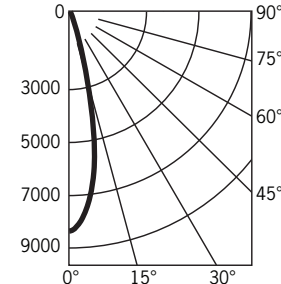

Spectral Power Distribution Chart⁴

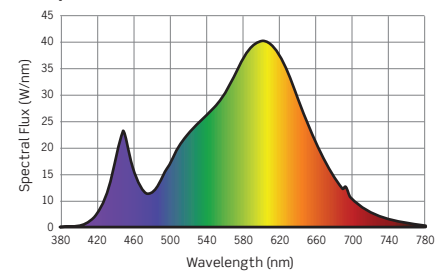

SQL3S330K12D1CF

Fixture Delivered Lumens: 2041.0
 Total Watts@120V: 20.5
 Lumens Per Watt: 99.6
 Center Beam Candle Power: 4582
 Beam Distribution: 40.5°
 Spacing Criterion: 0.64
 Color Rendering Index (CRI)¹: 83
 Color Temperature (CCT)²: 3107K
 Designed for 50,000 Hour Lamp Life³
 LM-63 Test No. G20012802
 LM-79 Test No. S20013101

Intensity Distribution

DISTANCE (FT.)	FOOTCANDLES (FC)	BEAM DIAMETER (FT.)
4'	286.4	3.0
6'	127.3	4.4
8'	71.6	5.9
10'	45.8	7.4
12'	31.8	8.9
14'	23.4	10.3

Candela Curve

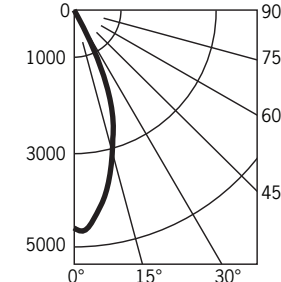

Spectral Power Distribution Chart⁴

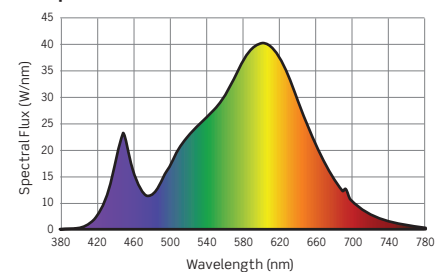

1. Accuracy of Rendering Colors 2. Color Appearance of Light Source 3. Dependent on Surrounding Temperatures 4. Colors Present within the Light Source

PHOTOMETRIC MULTIPLICATION FACTORS

Lumen output values fluctuate based on CCT. To estimate lumen output of the various CCT/CRI options, multiply 3000K (80 CRI min) results by the following:

CCT	CCT MULTIPLIERS		OUTPUT MULTIPLIERS		
	STD CRI	HIGH CRI	10W	14W	WET LOCATION OPT.
2700K	0.935	0.703	0.59	0.78	0.94
3000K	N/A	0.754	0.59	0.78	0.94
3500K	1.0	0.812	0.59	0.78	0.94
4000K	1.0	0.870	0.59	0.78	0.94

DATE

PROJECT

TYPE

SQL3 SERIES | 3-1/2 Inch Indoor/Outdoor Square Cylinders

SQL3S330K12D1CWF

Fixture Delivered Lumens: 1701.7
 Total Watts@120V: 20.5
 Lumens Per Watt: 83.0
 Center Beam Candle Power: 1276
 Beam Distribution: 66.0°
 Spacing Criterion: 1.00
 Color Rendering Index (CRI)¹: 83
 Color Temperature (CCT)²: 3107K
 Designed for 50,000 Hour Lamp Life³
 LM-63 Test No. G20012801
 LM-79 Test No. S20013101

Intensity Distribution

DISTANCE (FT.)	FOOTCANDLES (FC)	BEAM DIAMETER (FT.)
4 FT	79.8	5.2
6 FT	35.5	7.8
8 FT	19.9	10.4
10 FT	12.8	13.0
12 FT	8.9	15.6
14 FT	6.5	18.2

Candela Curve

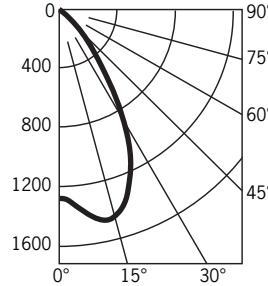

Spectral Power Distribution Chart⁴

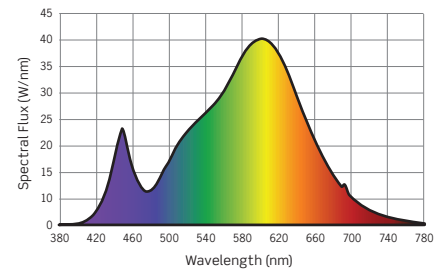

SQL3S330K12D1CWW

Fixture Delivered Lumens: 874.8
 Total Watts@120V: 20.3
 Lumens Per Watt: 43.1
 Center Beam Candle Power: 760
 Beam Distribution: 48.0°
 Spacing Criterion: 0.86
 Color Rendering Index (CRI)¹: 83
 Color Temperature (CCT)²: 3107K
 Designed for 50,000 Hour Lamp Life³
 LM-63 Test No. G20012902
 LM-79 Test No. S20013101

Intensity Distribution

DISTANCE (FT.)	FOOTCANDLES (FC)	BEAM DIAMETER (FT.)
4 FT	47.5	3.8
6 FT	21.1	5.7
8 FT	11.9	7.6
10 FT	7.6	9.5
12 FT	5.3	11.4
14 FT	3.9	13.3

Candela Curve

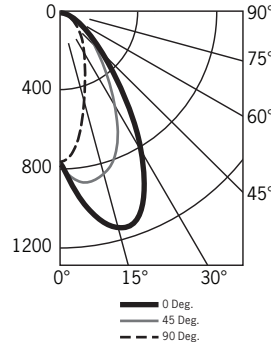

Spectral Power Distribution Chart⁴

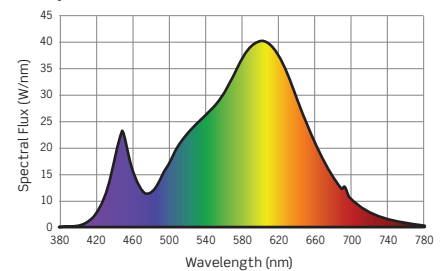

1. Accuracy of Rendering Colors 2. Color Appearance of Light Source 3. Dependent on Surrounding Temperatures 4. Colors Present within the Light Source

PHOTOMETRIC MULTIPLICATION FACTORS

Lumen output values fluctuate based on CCT. To estimate lumen output of the various CCT/CRI options, multiply 3000K (80 CRI min) results by the following:

CCT	CCT MULTIPLIERS		OUTPUT MULTIPLIERS		
	STD CRI	HIGH CRI	10W	14W	WET LOCATION OPT.
2700K	0.935	0.703	0.59	0.78	0.94
3000K	N/A	0.754	0.59	0.78	0.94
3500K	1.0	0.812	0.59	0.78	0.94
4000K	1.0	0.870	0.59	0.78	0.94

BUG RATINGS

Not valid for Up/Down (U/D) or Wall Mount (W) when oriented as an Uplight

	REFLECTOR				
	SPOT	MEDIUM	FLOOD	WIDE FLOOD	WALL WASH ¹
10W	B1 U0 G0	B1 U0 G0	B1 U0 G0	B1 U0 G0	B0 U0 G0
14W	B1 U0 G0	B1 U0 G0	B1 U0 G0	B1 U0 G0	B1 U0 G0
20W	B2 U0 G0	B2 U0 G0	B2 U0 G0	B2 U0 G0	B0 U0 G0

1. Wall Wash Rating based on Reflector used as Forward Throw

SQL3 SERIES | 3-1/2 In Indoor/Outdoor Square Cylinders: Dimming Specifications

- Incandescent 120VAC Dimmers adjust the light with “forward phase control”, where the dimmer “chops” the forward part of the AC wave to deliver less or more power to the light source. No neutral wire connection required.
- Electronic Low Voltage 120VAC Dimmers adjust the light with “reverse phase control”, where the dimmer “chops” the back part of the AC wave to deliver less or more power to the light source. Neutral wire connection required.
- 0-10V DC Low Voltage Dimmers operate using two low voltage dimming wires that are separate from the 120V or 277V AC power. The Dimmer sends a variable output voltage to the fixture based upon the dimming level. 10V Corresponds to undimmed operation, 5V to 50% and so on. Switching on/off is controlled with the line voltage power input (120V or 277V AC) to the Dimmer and then dimming operation is controlled with the 0-10V DC low voltage wiring connection between the Dimmer and the LED Driver. The control signal runs on two low voltage control wires (color coded violet and pink/gray).
- Lutron HiLume and EcoSystem Drivers provide continuous dimming from 1%-100%. For a complete list of compatible dimmers and controls, please visit www.lutron.com

			SQL3* Dimming Option 12D1 or MVD2
Manufacturer	Product	Model	Light Output
Leviton	IllumaTech	IPI06-1LZ	1%-100%
Leviton	SureSlide	6631-2	1%-100%
Leviton	Vizia	VPE06	9%-100%
Leviton	Trimatron	6683-IW	4%-100%
Leviton	Decora	6161	15%-100%
Leviton	SureSlide	6633-P	0%-100%
Leviton	IllumaTech	IPE04	6%-100%
Leviton	IllumaTech	IP710-DLX	NA
Lutron	Ariadni	TGCL-153P	4%-100%
Lutron	Ariadni	TG-600P	11%-100%
Lutron	Diva	DVCL-153P	0%-100%
Lutron	Diva	DV600P	0%-100%
Lutron	Diva	DVELV303P	6%-100%
Lutron	Diva	DVTV	NA
Lutron	Faedra	FAELV500	12%-100%
Lutron	Lumea	LG600P	5%-100%
Lutron	Maestro	MAELV600	11%-100%
Lutron	Nova	NFTV	NA
Lutron	Nova T	NTFTV	NA
Lutron	Skylark	S-603PG	4%-96%
Lutron	Skylark	S600P	1%-100%
Lutron	Skylark	SELV300P	7%-100%
Lutron	Skylark	CT103P	9%-100%
Pass & Seymour	Titan	CD4FB-W	NA
Watt Stopper	Miro Decorator	DCLV1	NA
Synergy		ISD BC	NA
Cooper	Devine	DLC03P	1%-100%
Cooper	Skye	SLC03P	0%-100%
Cooper	Decorator	DAL06P	0%-100%

*277V Triac Dimming is not available

NOTES

1. Testing was performed with a single fixture connected to dimmer.
2. Testing has been performed on these dimmers, but this does not imply any warranty of compatibility.
3. Dimming performance can be influenced by different loads, as well as variations in dimmer switches within the same model.
4. Dimmer maximum load rating with LED may differ from published traditional source dimmer ratings. Consult manufacturer for maximum dimmer information.
5. Consult factory for additional dimming information.