

DATE

PROJECT

TYPE

SQL6 SERIES | 6 Inch Indoor/Outdoor Square Cylinders: Flexible Cable Pendant



Nominal Weight: 11 Lbs

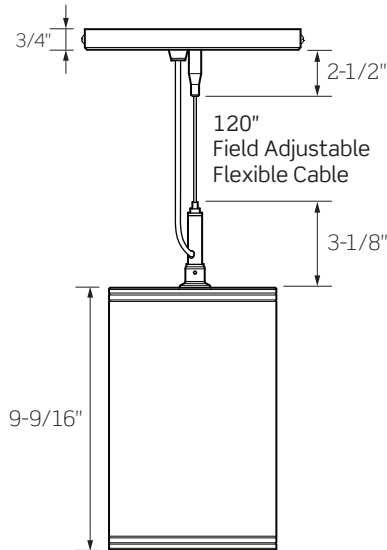

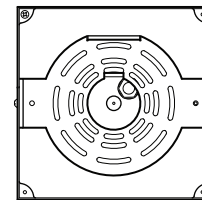

Top View

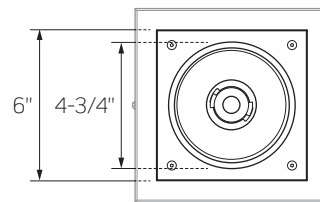

Bottom View



	SQL61	SQL62	SQL63	SQL64	SQL65	SQL66
WATTAGE	10W	14W	20W	28W	36W	43W
LUMEN OUTPUT ¹	1220Lm	1700Lm	2310Lm	3183Lm	3879Lm	4358Lm
COLOR TEMPERATURE	2700K / 3000K / 3500K / 4000K					
CRI	83 (80min) / 90+					
REFLECTOR BEAM	36° / 54° / 63° / 80° / Wall Wash / Pencil Beam					
REFLECTOR FINISHES	Clear Alzak (Narrow, Medium, Wide) / Platinum (Medium)					
CYLINDER FINISHES	Matte Black / Satin Bronze / Matte White / Matte Silver / Custom Colors Available					
DRIVER INPUT WATTAGE	10W	14W	20W	28W	36W	43W
INPUT CURRENT (A) 120V/277V	.08/.04	.12/.06	.17/.08	.23/.11	.31/.14	.36/.16
INPUT VOLTAGE/DIMMING TYPE	Std Driver (TRIAC, ELV, 0-10V) 120VAC/277VAC, 50/60Hz					
Lutron HiLume® Driver	120VAC, 50/60Hz			N/A	N/A	N/A
Lutron Eco-System® Driver	120VAC/277VAC, 50/60Hz				N/A	N/A
eldoLED ECOdrive/SOLOdrive	120VAC/277VAC, 50/60Hz					
DIMMING RANGE	Std Driver (TRIAC, ELV, 0-10V) 10-100%					
Lutron HiLume® Driver	1-100%					
Lutron Eco-System® Driver	1-100%					
eldoLED ECOdrive/SOLOdrive	0.1-100%					
DRIVER POWER FACTOR	> 0.90					
TOTAL HARMONIC DISTORTION	< 20%					
LISTINGS	  cCSAus Certified for use in the U.S. and Canada; Suitable for Damp/Dry Locations ENERGY STAR® Certified; the Series 6 (43W)/2700K Combination and Wall Wash options are not ENERGY STAR® Certified All models must be installed per specific product installation instructions and all appropriate National Electrical Codes					
WARRANTY	Five (5) year replacement after date of purchase					
SYSTEM RATING	50,000 Hours @ 70% Lumen Maintenance					

1. Approximate lumen output based on 3000K performance; see photometric test results for additional information

DATE

PROJECT

TYPE

SQL6 SERIES | 6 Inch Indoor/Outdoor Square Cylinders: Flexible Cable Pendant

ORDERING INFORMATION

Example Order: - -

LED Series	Color Temp/CRI	Driver/Dimming	Mounting	Reflector Beam
SQL61 - 10W / 1220lm	83 (80min) CRI	MVD - 120V-277V TRIAC, ELV, 0-10V Dimming	FC - Flexible Cable Canopy Mount	NCLR - 36° Narrow, Clear Alzak
SQL62 - 14W / 1700lm	27K - 2700K	34D2 - 347V 0-10V Dimming		MCLR - 54° Medium, Clear Alzak
SQL63 - 20W / 2310lm	30K - 3000K	12D3¹ - Lutron Hi-lume 1% 2-Wire LED Driver (120V Forward Phase Only)		WCLR - 80° Wide, Clear Alzak
SQL64 - 28W / 3183lm	35K - 3500K	MVD4² - Lutron Hi-lume 1% EcoSystem LED Driver with Soft-on, Fade-to-Black		PL - 63° Platinum
SQL65 - 36W / 3879lm	40K - 4000K	MVD6 - eldoLED ECOdrive 0-10V, 1% Dimming		WW - Wall Wash
SQL66 - 43W / 4358lm	90+ CRI	MVD7 - eldoLED ECOdrive DALI, 1% Dimming		
	27KC - 2700K	MVD8 - eldoLED SOLOdrive 0-10V, 0.1% Dimming		
	30KC - 3000K	MVD9 - eldoLED SOLOdrive DALI, 0.1% Dimming		
	35KC - 3500K	MDMX - eldoLED POWERdrive DMX <1% Dimming		
	40KC - 4000K			

Finish

- B** - Matte Black
- BZ** - Satin Bronze
- P** - Matte White
- S** - Matte Silver
- CC³** - Custom Color

Battery and Remote Enclosure^{4,5}

- None, Leave Blank
- RDB** - Remote Driver & Battery Pack
- RD** - Remote Driver Enclosure

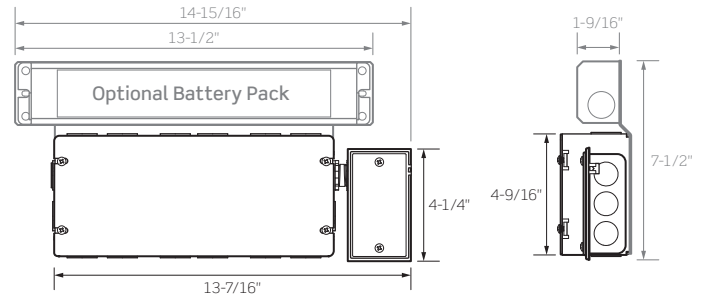

- Lutron Dimming Option 12D3 Hi-lume 1% 2-Wire LED Driver is available for Series 1 through 3 luminaires only (10W through 20W); not available for use with Series 4, 5 or 6 (28W, 36W or 43W) luminaires
- Lutron Dimming Option MVD4 Hi-lume 1% EcoSystem LED Driver is available for Series 1 through 4 luminaires only (10W through 28W); not available for use with Series 5 or 6 (36W or 43W) luminaires
- Custom Finish colors available; consult factory for pricing, minimum order quantities and lead time
- RDB and RD Options must be installed in Dry/Damp locations
- RDB and RD Options cannot be used with Lutron Hi-lume Dimming (12D3/MVD4 Options) in Series 5 or 6 (36W or 43W) luminaires

RDB: Remote Driver & Battery Pack
Battery Flexible Conduit Whips Not Pictured
RD: Remote Driver Enclosure

DRIVER AVAILABILITY MATRIX

Highest wattage option for each Driver/Dimmer type that will fit inside the luminaire;

Driver sizes that do not fit inside the luminaire may be ordered with a Remote Driver Housing (RD), unless otherwise noted with additional restrictions.

Driver	Max Wattage	Driver	Max Wattage	Driver	Max Wattage
MVD 120V-277V TRIAC/ELV	Any Wattage	MVD6 eldoLED ECOdrive 0-10V	Up to 36W (SQL65)	MVD9 eldoLED SOLOdrive DALI	Up to 36W (SQL65)
12D3⁵ 120V Lutron Hi-lume 1% 2-Wire	Up to 20W (SQL63)	MVD7 eldoLED ECOdrive DALI	Up to 36W (SQL65)	MDMX eldoLED POWERdrive DMX	N/A
MVD4⁵ Lutron Hi-lume 1% EcoSystem	Up to 28W (SQL64)	MVD8 eldoLED SOLOdrive 0-10V	Up to 36W (SQL65)	34D2 347V 0-10V	Any Wattage

5. RDB and RD Options cannot be used with Lutron Hi-lume Dimming (12D3/MVD4 Options) in Series 5 or 6 (36W or 43W) luminaires

DATE

PROJECT

TYPE

SQL6 SERIES | 6 Inch Indoor/Outdoor Square Cylinders: Flexible Cable Pendant

PRODUCT DETAILS

Construction

- Specification Grade 6 inch square Aluminum Housing; suitable for Dry/Damp (indoor) locations
- Includes 120 inches of Field Adjustable Cable and Steel Aircraft Cable for support
- Black Flexible Cable with Black or Bronze Cylinders, White Flexible Cable with White Cylinders and Gray Flexible Cable with Silver Cylinders

Performance Summary

- Clear Alzak Reflector is available in 36° Narrow, 54° Medium and 80° Wide beam distributions
- Platinum Reflector is available in a 63° Medium beam distribution
- Wall Wash Optic also available
- 2700K, 3000K, 3500K and 4000K Color Temperatures; CRI of 80 min., 83 typical; high CRI of 90+ available
- Excellent fixture-to-fixture color consistency within a 3-step MacAdam Ellipse tolerance
- Battery Backup option provides 90 minutes of power
- UL8750 and Class 2 compliant: RoHS compliant, U.S. only
- Output over voltage, over current and short circuit protected
- SQL6 Cylinders are available for non-dimming and dimming applications; for dimmer compatibility, refer to Dimming Specification sheet

BUG RATINGS

LED WATTAGE	REFLECTOR					
	NARROW	MEDIUM	WIDE	PLATINUM	WALL WASH ¹	PENCIL BEAM
10W	B1 U0 G0	B1 U0 G0	B1 U0 G1	B1 U0 G1	B0 U0 G0	B0 U0 G0
14W	B1 U0 G0	B2 U0 G0	B2 U0 G0	B2 U0 G0	B0 U0 G0	B0 U0 G0
20W	B1 U0 G0	B2 U0 G0	B2 U0 G0	B2 U0 G0	B0 U0 G0	B0 U0 G0
28W	B1 U0 G0	B2 U0 G0	B2 U0 G0	B2 U0 G0	B0 U0 G0	B0 U0 G0
36W	B2 U0 G0	B3 U0 G0	B3 U0 G1	B3 U0 G1	B1 U0 G0	B0 U0 G0
43W	B2 U0 G0	B3 U0 G0	B3 U0 G1	B3 U0 G1	B1 U0 G0	B0 U0 G0

1. Wall Wash Rating based on Reflector used as Forward Throw

DATE

PROJECT

TYPE

SQL6 SERIES | 6 Inch Indoor/Outdoor Square Cylinders: Photometrics

SQL6630KMVDCNCLR

Fixture Delivered Lumens: 4306.3
 Total Watts@120V: 42.2
 Lumens Per Watt: 102.0
 Center Beam Candle Power: 7509
 Beam Distribution: 35.0°
 Spacing Criterion: 0.62
 Color Rendering Index (CRI)¹: 83.6
 Color Temperature (CCT)²: 3086K
 Designed for 50,000 Hour Lamp Life³
 LM-63 Test No. G21091502
 LM-79 Test No. S21081101

Intensity Distribution

DISTANCE (FT.)	FOOTCANDLES (FC)	BEAM DIAMETER (FT.)
4 FT	469.3	2.5
6 FT	208.6	3.8
8 FT	117.3	5.0
10 FT	75.1	6.3
12 FT	52.1	7.6
14 FT	38.3	8.8

Candela Curve

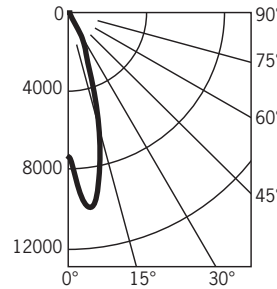

Spectral Power Distribution Chart⁴

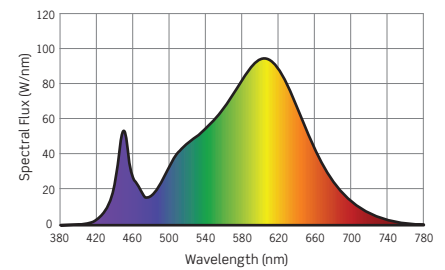

SQL6630KMVDCMCLR

Fixture Delivered Lumens: 4357.9
 Total Watts@120V: 42.2
 Lumens Per Watt: 103.3
 Center Beam Candle Power: 5567
 Beam Distribution: 53.7°
 Spacing Criterion: 0.820
 Color Rendering Index (CRI)¹: 83.6
 Color Temperature (CCT)²: 3086K
 Designed for 50,000 Hour Lamp Life³
 LM-63 Test No. G21091501
 LM-79 Test No. S21081101

Intensity Distribution

DISTANCE (FT.)	FOOTCANDLES (FC)	BEAM DIAMETER (FT.)
4 FT	347.9	4.1
6 FT	154.6	6.1
8 FT	87.0	8.1
10 FT	55.7	10.1
12 FT	38.7	12.2
14 FT	28.4	14.2

Candela Curve

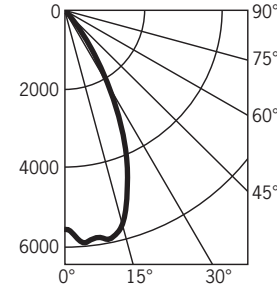

Spectral Power Distribution Chart⁴

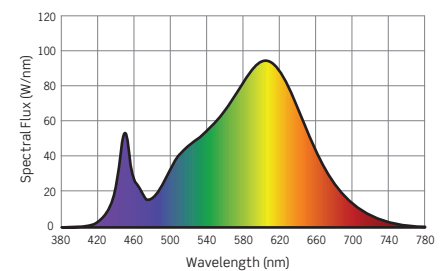

SQL6330KMVDCWCLR

Fixture Delivered Lumens: 4174.3
 Total Watts@120V: 42.2
 Lumens Per Watt: 98.9
 Center Beam Candle Power: 2383
 Beam Distribution: 79.8°
 Spacing Criterion: 1.20
 Color Rendering Index (CRI)¹: 83.6
 Color Temperature (CCT)²: 3086K
 Designed for 50,000 Hour Lamp Life³
 LM-63 Test No. G21091503
 LM-79 Test No. S21081101

Intensity Distribution

DISTANCE (FT.)	FOOTCANDLES (FC)	BEAM DIAMETER (FT.)
4 FT	148.9	6.7
6 FT	66.2	10.0
8 FT	37.2	13.4
10 FT	23.8	16.7
12 FT	16.5	20.1
14 FT	12.2	23.4

Candela Curve

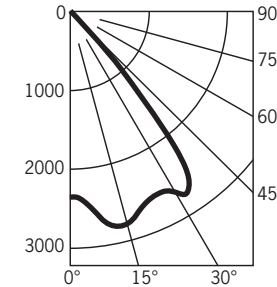

Spectral Power Distribution Chart⁴

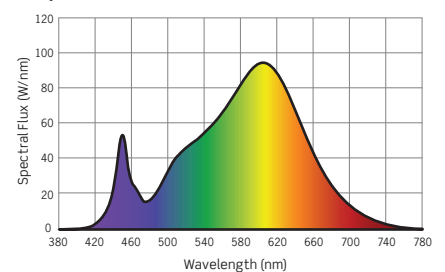

1. Accuracy of Rendering Colors 2. Color Appearance of Light Source 3. Dependent on Surrounding Temperatures 4. Colors Present within the Light Source

PHOTOMETRIC MULTIPLICATION FACTORS

Lumen output values fluctuate based on Color Temperature, Luminaire Wattage/Output and Trim Selection. To estimate lumen output of these various options, multiply 3000K results by the following:

CCT MULTIPLIERS			OUTPUT MULTIPLIERS				
CCT	STD CRI	HIGH CRI	10W/SERIES 1	14W/SERIES 2	20W/SERIES 3	28W/SERIES 4	36W/SERIES 5
2700K	0.94	0.70	0.28	0.39	0.53	0.72	0.89
3000K	N/A	0.75					
3500K	1.0	0.81					
4000K	1.0	0.87					

DATE

PROJECT

TYPE

SQL6 SERIES | 6 Inch Indoor/Outdoor Square Cylinders: Photometrics

SQL6630KMVDCPL

Fixture Delivered Lumens: 3823.3
 Total Watts@120V: 42.2
 Lumens Per Watt: 90.6
 Center Beam Candle Power: 4440
 Beam Distribution: 63.1°
 Spacing Criterion: 0.93
 Color Rendering Index (CRI)¹: 83.6
 Color Temperature (CCT)²: 3086K
 Designed for 50,000 Hour Lamp Life³
 LM-63 Test No. G21091504
 LM-79 Test No. S21081101

Intensity Distribution

DISTANCE (FT.)	FOOTCANDLES (FC)	BEAM DIAMETER (FT.)
4 FT	277.5	4.9
6 FT	123.3	7.4
8 FT	69.4	9.8
10 FT	44.4	12.3
12 FT	30.8	14.7
14 FT	22.7	17.2

Candela Curve

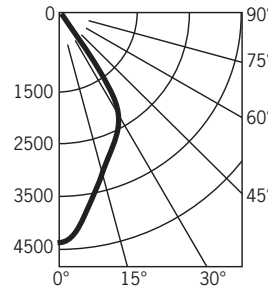

Spectral Power Distribution Chart⁴

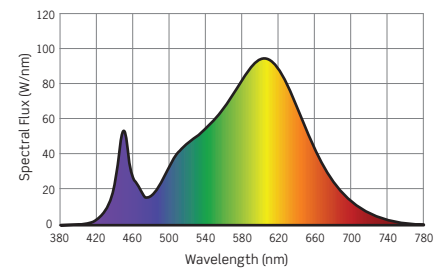

SQL6630KMVDCWW

Fixture Delivered Lumens: 2168.7
 Total Watts@120V: 42.1
 Lumens Per Watt: 51.5
 Center Beam Candle Power: 2146
 Beam Distribution: Wall Wash
 Spacing Criterion: 0.81
 Color Rendering Index (CRI)¹: 83.6
 Color Temperature (CCT)²: 3086K
 Designed for 50,000 Hour Lamp Life³
 LM-63 Test No. G21091601
 LM-79 Test No. S21081101

Intensity Distribution

DISTANCE (FT.)	FOOTCANDLES (FC)	BEAM DIAMETER (FT.)
4 FT	134.2	3.7
6 FT	59.6	5.6
8 FT	33.5	7.4
10 FT	21.5	9.3
12 FT	14.9	11.1
14 FT	11.0	13.0

Candela Curve

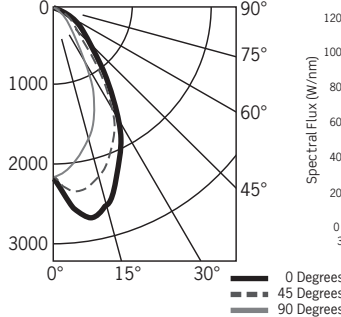

Spectral Power Distribution Chart⁴

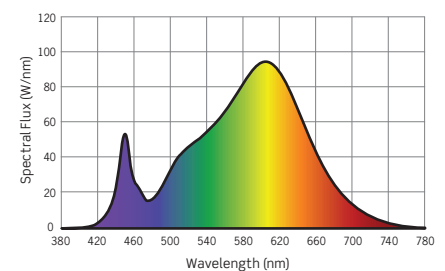

SQL6630KMVDCXPB

Fixture Delivered Lumens: 117.3
 Total Watts@120V: 42.1
 Lumens Per Watt: 2.8
 Center Beam Candle Power: 766
 Beam Distribution: 8.3°
 Spacing Criterion: 0.99
 Color Rendering Index (CRI)¹: 83.6
 Color Temperature (CCT)²: 3086K
 Designed for 50,000 Hour Lamp Life³
 LM-63 Test No. G22021602
 LM-79 Test No. S21081101

Intensity Distribution

DISTANCE (FT.)	FOOTCANDLES (FC)	BEAM DIAMETER (FT.)
4 FT	47.9	4.3
6 FT	21.3	6.4
8 FT	12.0	8.5
10 FT	7.7	10.6
12 FT	5.3	12.8
14 FT	3.9	14.9

Candela Curve

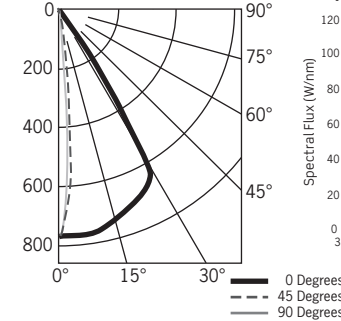

Spectral Power Distribution Chart⁴

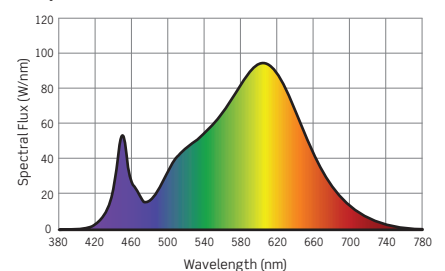

1. Accuracy of Rendering Colors 2. Color Appearance of Light Source 3. Dependent on Surrounding Temperatures 4. Colors Present within the Light Source

PHOTOMETRIC MULTIPLICATION FACTORS

Lumen output values fluctuate based on Color Temperature, Luminaire Wattage/Output and Trim Selection. To estimate lumen output of these various options, multiply 3000K results by the following:

CCT MULTIPLIERS			OUTPUT MULTIPLIERS				
CCT	STD CRI	HIGH CRI	10W/SERIES 1	14W/SERIES 2	20W/SERIES 3	28W/SERIES 4	36W/SERIES 5
2700K	0.94	0.70	0.28	0.39	0.53	0.72	0.89
3000K	N/A	0.75					
3500K	1.0	0.81					
4000K	1.0	0.87					

DATE

PROJECT

TYPE

SQL6 SERIES | 6 Inch Indoor/Outdoor Square Cylinders: Photometrics

TM-30 DATA: SQL6630KMVDCMLR

ANSI/IES TM-30-18 Color Rendition Report Test No. S21081101

Colors are for visual orientation purposes only

R_f	86
R_g	97
CCT(K)	3086K
D_{uv}	0.0017
u^l	0.2470
v^l	0.5220

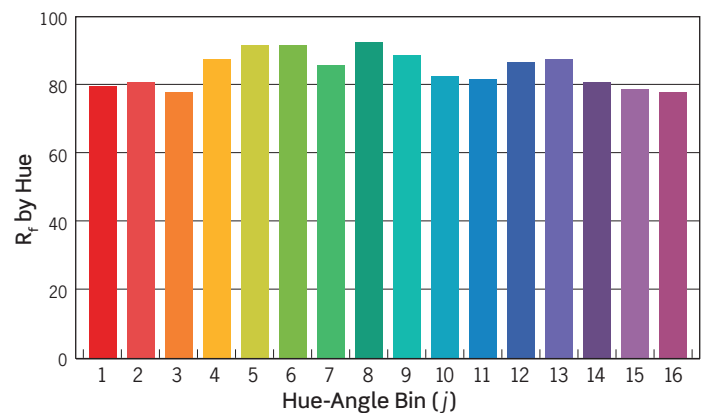
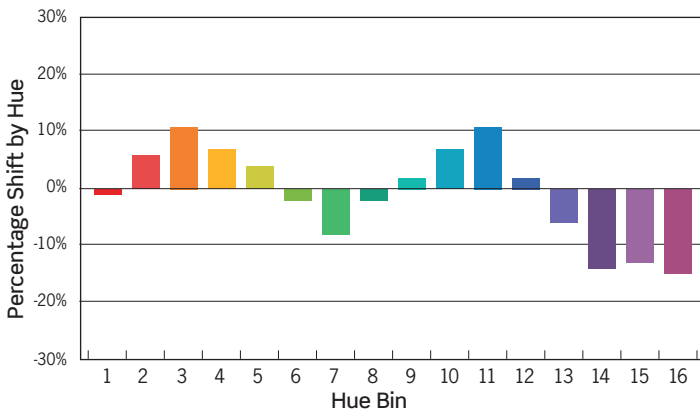
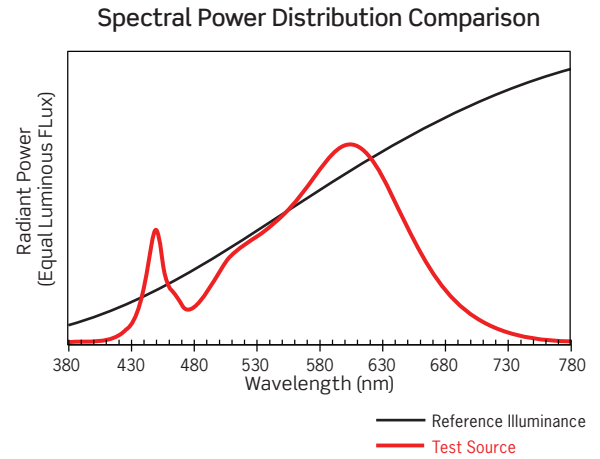
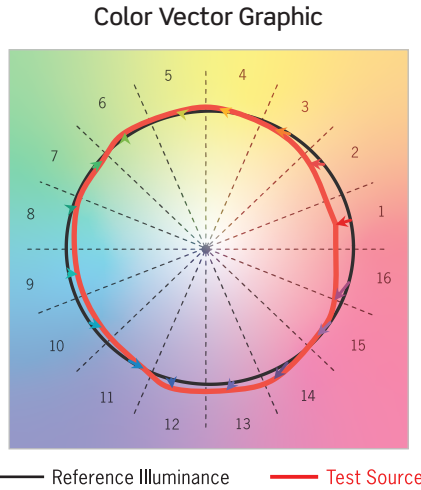

HUE BIN	1	2	3	4	5	6	7	8	9	10	11	12	13	14	15	16
HUE SHIFT	-1%	6%	10%	7%	4%	-2%	-7%	-2%	2%	7%	11%	2%	-6%	-14%	-13%	-15%
R_f VALUE	81	83	80	89	93	93	88	94	91	84	83	88	89	82	80	80

SQL6 SERIES | 6 Inch Indoor/Outdoor Square Cylinders: Dimming Specifications

- Incandescent 120VAC Dimmers adjust the light with “forward phase control,” where the dimmer “chops” the forward part of the AC wave to deliver less or more power to the light source. No neutral wire connection required.
- Electronic Low Voltage 120VAC dimmers adjust the light with “reverse phase control,” where the dimmer “chops” the back part of the AC wave to deliver less or more power to the light source. Neutral wire connection required.
- 0-10V DC Low Voltage Dimmers operate using two (2) low voltage dimming wires that are separate from the 120V or 277V AC power. The Dimmer sends a variable output voltage to the luminaire based upon the dimming level. 10V Corresponds to undimmed operation, 5V to 50% and so on. Switching On/Off is controlled with the line voltage power (120V or 277V AC) input to the Dimmer and then dimming operation is controlled with the 0-10V DC low voltage wiring connection between the Dimmer and the LED Driver. The control signal runs on two (2) low voltage control wires (color coded Purple and Pink/Grey).
- Lutron HiLume and EcoSystem Drivers provide continuous dimming from 1%-100%. For a complete list of compatible dimmers and controls, please visit www.lutron.com
- Use DALI approved controls for dimming eldoLED MVD7 (1%-100%) and MVD9 (0.1%-100%) options.

Manufacturer	Product	Model	MVD	MVD6	MVD8
			Dimming Option	Dimming Option	Dimming Option
			Light Output	Light Output	Light Output
Leviton	IllumaTech	IPI06-1LZ	1%-100%	NA	NA
Leviton	SureSlide	6631-2	1%-100%	NA	NA
Leviton	Vizia	VPE06	9%-100%	NA	NA
Leviton	Trimatron	6683-IW	6%-100%	NA	NA
Leviton	Decora	6161	15%-100%	NA	NA
Leviton	SureSlide	6633-P	1%-100%	NA	NA
Leviton	IllumaTech	IPE04	6%-100%	NA	NA
Leviton	IllumaTech	IP710-DLX	NA	1%-100%	0.1%-100%
Cooper	Devine	DLC03P	1%-100%	NA	NA
Cooper	Skye	SLC03P	0%-100%	NA	NA
Cooper	Decorator	DAL06P	0%-100%	NA	NA
Pass & Seymour	Titan	CD4FB-W	NA	1%-100%	0.1%-100%
Synergy		ISD BC	NA	1%-100%	0.1%-100%
Watt Stopper	Miro Decorator	DCLV1	NA	1%-100%	0.1%-100%
Lutron	Ariadni	TGCL-153P	1%-100%	NA	NA
Lutron	Ariadni	TG-600P	13%-100%	NA	NA
Lutron	Diva	DVCL-153P	1%-100%	NA	NA
Lutron	Diva	DV600P	6%-100%	NA	NA
Lutron	Diva	DVELV303P	6%-100%	NA	NA
Lutron	Diva	DVTV	NA	1%-100%	0.1%-100%
Lutron	Faetra	FAELV500	12%-100%	NA	NA
Lutron	Lumea	LG600P	8%-100%	NA	NA
Lutron	Maestro	MAELV600	16%-100%	NA	NA
Lutron	Nova	NFTV	NA	1%-100%	0.1%-100%
Lutron	Nova T	NTFTV	NA	1%-100%	0.1%-100%
Lutron	Skylark	S-603PG	5%-96%	NA	NA
Lutron	Skylark	S600P	5%-100%	NA	NA
Lutron	Skylark	SELV300P	10%-100%	NA	NA
Lutron	Skylark	CT103P	9%-100%	NA	NA

*277V Triac Dimming is not available

NOTES

1. Testing was performed with a single fixture connected to dimmer.
2. Testing has been performed on these dimmers, but this does not imply any warranty of compatibility.
3. Dimming performance can be influenced by different loads, as well as variations in dimmer switches within the same model.
4. Dimmer maximum load rating with LED may differ from published traditional source dimmer ratings. Consult manufacturer for maximum dimmer information.
5. Consult factory for additional dimming information.