

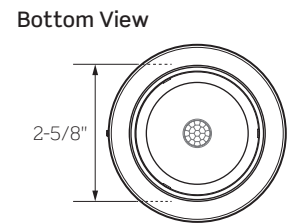
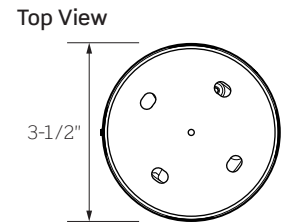
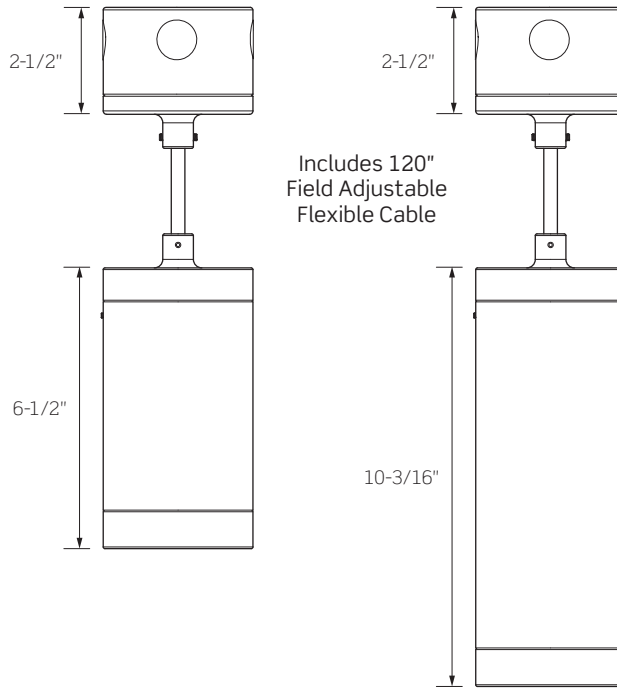

DATE

PROJECT

TYPE

CY3 SERIES | 3-1/2-Inch Round Indoor Cylinders: Flex Cable Pendant with Conduit Feed Mounting Box



	CY3S1/CY3T1	CY3S2/CY3T2	CY3S3/CY3T3
WATTAGE	10W	14W	20W
LUMEN OUTPUT ¹	1200Lm	1653Lm	2286Lm
COLOR TEMPERATURE	2700K / 3000K / 3500K / 4000K		
CRI	83 (80min) / 90+		
BEAM	13° Spot / 29° Medium / 44° Flood / 60° Wide Flood / Wall Wash		
LUMINAIRE HEIGHT	6-1/2-Inch (Short) / 10-3/16-Inch (Tall) / 2-1/2-Inch Deep Conduit Feed Mounting Box		
FINISHES	Matte Black / Satin Bronze / Matte White / Matte Silver / Custom Colors Available		
DRIVER INPUT WATTAGE	10W	14W	20W
DRIVER INPUT VOLTAGE	120V – 277V Dimming, 50/60Hz		
DIMMING TYPE	120V TRIAC/ELV 120V – 277V 0-10V Lutron HiLume EcoSystem		
LISTINGS	   cCSAus Certified for use in the U.S. and Canada; Suitable for Damp/Dry locations Cylinders with Conduit Feed Boxes must be installed per specific Product Installation Instructions and all appropriate NEC Codes ENERGY STAR® Certified		
WARRANTY	Five (5) year replacement after date of purchase		
SYSTEM RATING	50,000 Hours @ 70% Lumen Maintenance		

1. Approximate lumen output based on 3000K performance; see photometric test results for additional information

DATE

PROJECT

TYPE

CY3 SERIES | 3-1/2-Inch Round Indoor Cylinders: Flex Cable Pendant with Conduit Feed Mounting Box

ORDERING INFORMATION

Example Order: - -

Cyl. Height	LED Series	Color Temp/CRI	Driver/Dimming	Mounting	Beam
CY3S - 6-1/2-In.	1 - 10W 1200lm	83 (80min) CRI 27K - 2700K 30K - 3000K 35K - 3500K 40K - 4000K	12D1 - 120V TRIAC/ELV MVD2 - 120V-277V 0-10V Dimming MVD4 ¹ - Lutron HiLume 1% EcoSystem Driver with Soft-On, Fade-to-Black	SFC - Flexible Cable Pendant with Conduit Box	S - 13° Spot M - 29° Medium F - 44° Flood WF - 60° Wide Flood WW ² - Wall Wash
CY3T -10-3/16-In.	2 - 14W 1653lm 3 - 20W 2286lm	90+ CRI 27KC - 2700K 30KC - 3000K 35KC - 3500K 40KC - 4000K			

Finish

- B** - Matte Black
- BZ** - Satin Bronze
- P** - Matte White
- S** - Matte Silver
- CC**³ - Custom Color

Battery and Remote Enclosure⁴

- None, Leave Blank
- RDB** - Remote Driver & Battery Pack
- RD** - Remote Driver Enclosure

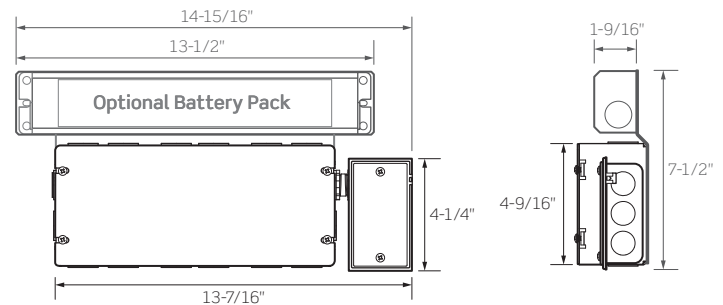

RDB: Remote Driver & Battery Pack
Battery Flexible Conduit Whips Not Pictured

RD: Remote Driver Enclosure

- Lutron HiLume Drivers must use Remote Driver Enclosure (RD Option)
- Wall Wash Optic (WW) is not field interchangeable with Spot, Medium, Flood and Wide Flood Optics
- Custom Color finishes available; consult factory for pricing, minimum order quantities and lead time
- RD and RDB Options must be installed in Dry/Damp Locations

ACCESSORY ORDERING INFORMATION

Replacement Optics

- CY3-OPTIC-S** - 13° Spot
- CY3-OPTIC-M** - 29° Medium
- CY3-OPTIC-F** - 44° Flood
- CY3-OPTIC-WF** - 60° Wide Flood

Spot (S), Medium (M), Flood (F), and Wide Flood (WF) Optics are not interchangeable with Wall Wash (WW) options

Accessories

- FA-47** - Accessory Holder
- FA-16 60MM** - 2-3/8-Inch Diameter Black Honeycomb Louver; Requires FA-47 Accessory Holder
- LF16-* 60MM** - 2-3/8-Inch Diameter Tempered Glass Lenses and Filters: 1/8-Inch Thick, typical; requires FA-47 Accessory Holder

*Color/Pattern Legend

- 73** (Spread Lens), **-LS** (Linear Spread Lens), **-SL** (Soft Light), **-SOL** (Solite),
- UV** (Optivex UV Filter), **-A** (Amber), **-B** (Blue), **-CL** (Clear), **-DPE** (Dichroic Peach),
- G** (Green), **-LB** (Light Blue), **-R** (Red), **-RO** (Rose), **-Y** (Yellow)

DATE

PROJECT

TYPE

CY3 SERIES | 3-1/2-Inch Round Indoor Cylinders: Flex Cable Pendant with Conduit Feed Mounting Box

PRODUCT DETAILS

Construction

- Specification Grade 3-1/2-inch diameter Aluminum Housing for indoor applications
- Cast Aluminum Driver Canopy with a four (4) outlet, 3-1/2-inch diameter Junction Box with hardware for 3/4-inch EMT Conduit and Hubs
- Available in 6-1/2- and 10-3/16-inch heights
- Suitable for Dry/Damp (Indoor) location types
- Includes 120-inches (10 ft.) of field adjustable 18/3 or 18/5 SJT Cable
- Black Flexible Cable with Black or Bronze Cylinders, White Cable with White Cylinders and Gray Cable with Silver Cylinders

Performance Summary

- Available in 13° Spot, 29° Medium, 44° Flood and 60° Wide Flood Beam Distributions, as well as a Wall Wash option
- Wall Wash Optic may be rotated 360° to aim distribution pattern
- Optics have been optically engineered to provide a smooth uniform beam, maximizing output and minimizing glare
- Optics can be easily changed in the field for optimal flexibility; Wall Wash Optic (WW) is not field interchangeable with Spot, Medium, Flood or Wide Flood Optics
- 2700K, 3000K, 3500K and 4000K Color Temperatures; CRI 80 of min., 83 typical; high CRI 90+ available
- Excellent fixture-to-fixture color consistency within a 3-step MacAdam Ellipse tolerance
- Battery Backup option provides 90 minutes of power
- UL8750 and Class 2 compliant: RoHS compliant, U.S. only
- Output over voltage, over current and short circuit protected
- CY3 Cylinders are available for non-dimming and dimming applications; for dimmer compatibility, refer to Dimming Specification sheet

DATE

PROJECT

TYPE

CY3 SERIES | 3-1/2 In Indoor/Outdoor Round Cylinders

PHOTOMETRICS

CY3S330K12D1CS: Spot Optic

Fixture Delivered Lumens: 2197.22
 Total Watts@120V: 19.679
 Lumens Per Watt: 111.534
 Center Beam Candle Power: 14522
 Beam Distribution: 12.54°
 Spacing Criterion: 0.3135
 Color Rendering Index (CRI)¹: 83
 Color Temperature (CCT)²: 3101K

Designed for 50,000 Hour Lamp Life³
 LM-63 Test No. G24020204
 LM-79 Test No. S24020101

Intensity Distribution

DISTANCE (FT.)	FOOTCANDLES (FC)	BEAM DIAMETER (FT.)
4 FT	907.6	0.88
6 FT	403.4	1.32
8 FT	226.9	1.76
10 FT	145.2	2.20
12 FT	100.8	2.64
14 FT	74.1	3.08

Candela Curve

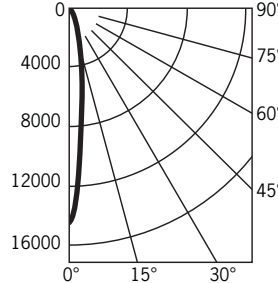

Spectral Power Distribution Chart⁴

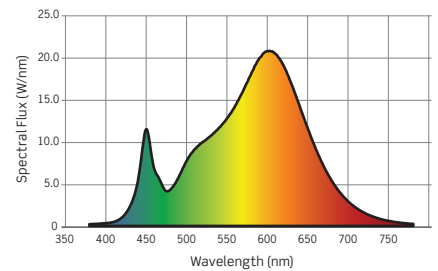

CY3S330K12D1CM: Medium Optic

Fixture Delivered Lumens: 2285.87
 Total Watts@120V: 19.672
 Lumens Per Watt: 116.034
 Center Beam Candle Power: 8583
 Beam Distribution: 29.28°
 Spacing Criterion: 0.4628
 Color Rendering Index (CRI)¹: 83
 Color Temperature (CCT)²: 3101K

Designed for 50,000 Hour Lamp Life³
 LM-63 Test No. G24020203
 LM-79 Test No. S24020101

Intensity Distribution

DISTANCE (FT.)	FOOTCANDLES (FC)	BEAM DIAMETER (FT.)
4 FT	536.4	2.09
6 FT	238.4	3.13
8 FT	134.1	4.18
10 FT	85.8	5.22
12 FT	59.6	6.24
14 FT	43.8	7.31

Candela Curve

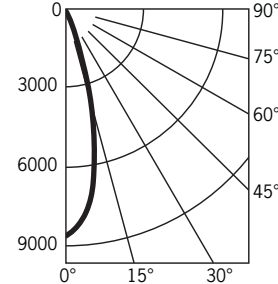

Spectral Power Distribution Chart⁴

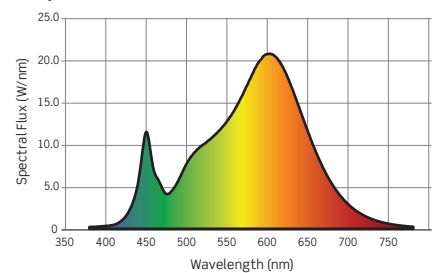

CY3S330K12D1CF: Flood Optic

Fixture Delivered Lumens: 2263.94
 Total Watts@120V: 19.675
 Lumens Per Watt: 114.921
 Center Beam Candle Power: 4311
 Beam Distribution: 43.77°
 Spacing Criterion: 0.6604
 Color Rendering Index (CRI)¹: 83
 Color Temperature (CCT)²: 3101K

Designed for 50,000 Hour Lamp Life³
 LM-63 Test No. G24020205
 LM-79 Test No. S24020101

Intensity Distribution

DISTANCE (FT.)	FOOTCANDLES (FC)	BEAM DIAMETER (FT.)
4 FT	269.4	3.21
6 FT	119.7	4.82
8 FT	67.4	6.43
10 FT	43.1	8.03
12 FT	29.9	9.64
14 FT	22.0	11.25

Candela Curve

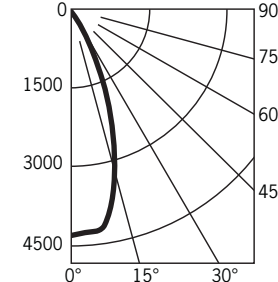

Spectral Power Distribution Chart⁴

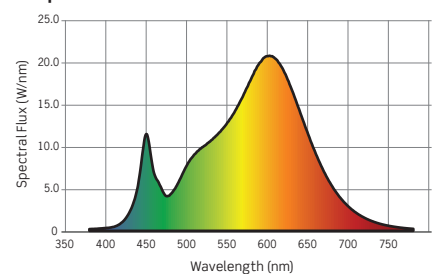

1. Accuracy of Rendering Colors 2. Color Appearance of Light Source 3. Dependent on Surrounding Temperatures 4. Colors Present within the Light Source

PHOTOMETRIC MULTIPLICATION FACTORS

Lumen output values fluctuate based on CCT. To estimate lumen output of the various CCT/CRI options, multiply 3000K (80 CRI min) results by the following:

CCT	CCT MULTIPLIERS		OUTPUT MULTIPLIERS		
	STD CRI	HIGH CRI	10W	14W	WET LOCATION OPT.
2700K	0.949	0.842	0.525	0.723	0.922
3000K	N/A	0.872			
3500K	1.02	0.895			
4000K	1.04	0.916			

DATE

PROJECT

TYPE

CY3 SERIES | 3-1/2 In Indoor/Outdoor Round Cylinders

PHOTOMETRICS

CY3S330K12D1CWF: Wide Flood Optic

Fixture Delivered Lumens: 1854.25
 Total Watts@120V: 19.675
 Lumens Per Watt: 94.1245
 Center Beam Candle Power: 1876
 Beam Distribution: 59.89°
 Spacing Criterion: 0.882
 Color Rendering Index (CRI)¹: 83
 Color Temperature (CCT)²: 3101K
 Designed for 50,000 Hour Lamp Life³
 LM-63 Test No. G24020206
 LM-79 Test No. S24020101

Intensity Distribution

DISTANCE (FT.)	FOOTCANDLES (FC)	BEAM DIAMETER (FT.)
4 FT	117.2	4.61
6 FT	52.1	6.91
8 FT	29.3	9.22
10 FT	18.8	11.52
12 FT	13.0	13.83
14 FT	9.6	16.13

Candela Curve

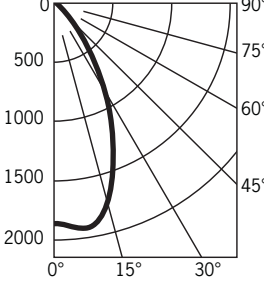

Spectral Power Distribution Chart⁴

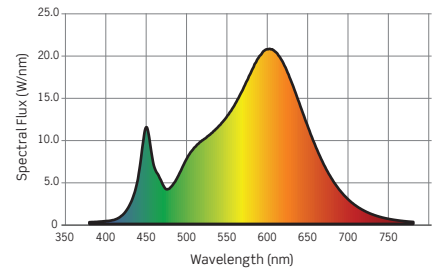

CY3S330K12D1CWW: Wall Wash

Fixture Delivered Lumens: 997.225
 Total Watts@120V: 19.718
 Lumens Per Watt: 50.6206
 Center Beam Candle Power: 927
 Beam Distribution: 50.35°
 Spacing Criterion: 0.8078
 Color Rendering Index (CRI)¹: 83
 Color Temperature (CCT)²: 3101K
 Designed for 50,000 Hour Lamp Life³
 LM-63 Test No. G24020207
 LM-79 Test No. S24020101

Intensity Distribution

DISTANCE (FT.)	FOOTCANDLES (FC)	BEAM DIAMETER (FT.)
4 FT	57.9	4.08
6 FT	25.7	6.08
8 FT	14.5	8.11
10 FT	9.3	10.14
12 FT	6.4	12.16
14 FT	4.7	14.19

Candela Curve

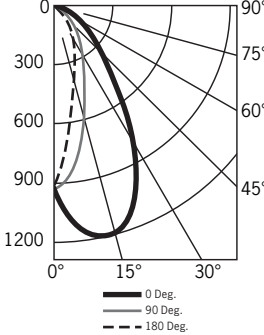

Spectral Power Distribution Chart⁴

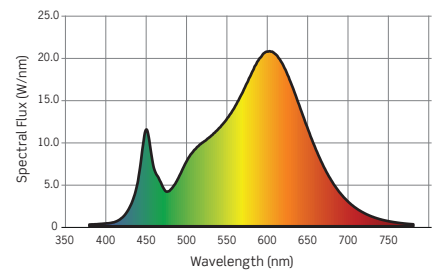

1. Accuracy of Rendering Colors 2. Color Appearance of Light Source 3. Dependent on Surrounding Temperatures 4. Colors Present within the Light Source

PHOTOMETRIC MULTIPLICATION FACTORS

Lumen output values fluctuate based on CCT. To estimate lumen output of the various CCT/CRI options, multiply 3000K (80 CRI min) results by the following:

CCT	CCT MULTIPLIERS		OUTPUT MULTIPLIERS		
	STD CRI	HIGH CRI	10W	14W	WET LOCATION OPT.
2700K	0.949	0.842	0.525	0.723	0.922
3000K	N/A	0.872			
3500K	1.02	0.895			
4000K	1.04	0.916			

BUG RATINGS

Not valid for Wall Mount (W) when oriented as an Uplight

	REFLECTOR				
	SPOT	MEDIUM	FLOOD	WIDE FLOOD	WALL WASH ¹
10W	B1 U0 G0	B1 U0 G0	B1 U0 G0	B1 U0 G0	B0 U0 G0
14W	B1 U0 G0	B1 U0 G0	B1 U0 G0	B1 U0 G0	B1 U0 G0
20W	B2 U0 G0	B2 U0 G0	B2 U0 G0	B2 U0 G0	B0 U0 G0

1. Wall Wash Rating based on Reflector used as Forward Throw

DATE

PROJECT

TYPE

CY3 SERIES | 3-1/2 In Indoor/Outdoor Round Cylinders

PHOTOMETRICS

TM-30 DATA: CY3S440K12D1CM

ANSI/IES TM-30-18 Color Rendition Report Test No. S24020101

Colors are for visual orientation purposes only

R_f	86
R_g	96
CCT(K)	3101 K
D_{uv}	-0.0002
u^I	0.2470
v^I	0.5196

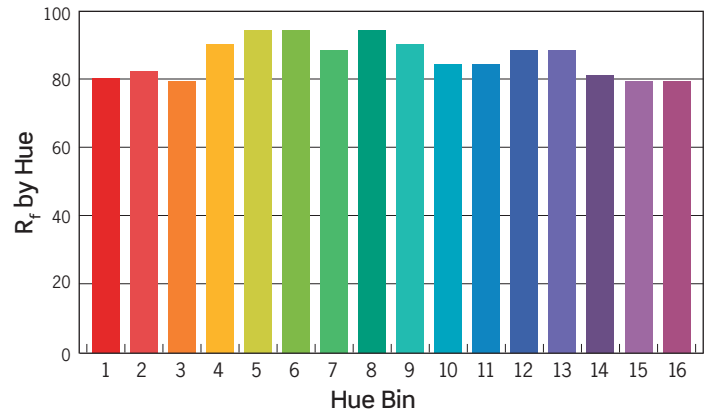
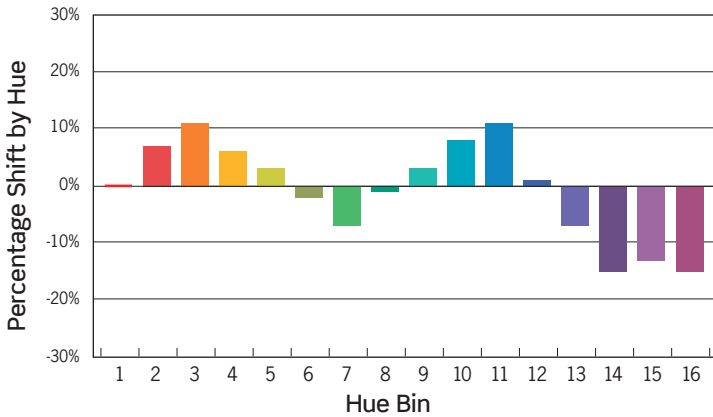
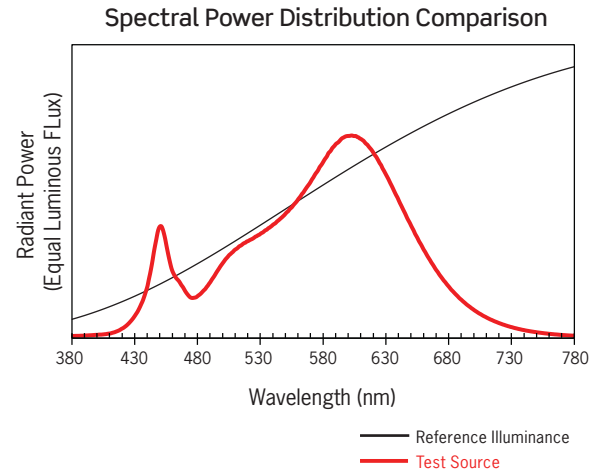
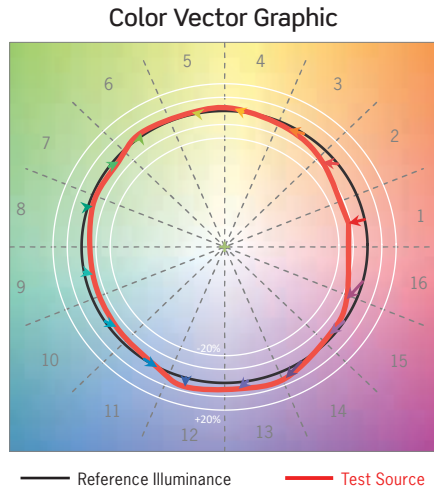

HUE BIN	1	2	3	4	5	6	7	8	9	10	11	12	13	14	15	16
HUE SHIFT	0%	7%	11%	6%	3%	-2%	-7%	-1%	3%	8%	11%	1%	-7%	-15%	-13%	-15%
R_f VALUE	80	82	79	90	94	94	88	94	90	84	84	88	88	81	79	79

Colors are for visual orientation purposes only

CY3 SERIES | 3-1/2-Inch Round Indoor/Outdoor Cylinders: Dimming Specifications

- Incandescent 120VAC Dimmers adjust the light with “forward phase control”, where the dimmer “chops” the forward part of the AC wave to deliver less or more power to the light source. No neutral wire connection required.
- Electronic Low Voltage 120VAC Dimmers adjust the light with “reverse phase control”, where the dimmer “chops” the back part of the AC wave to deliver less or more power to the light source. Neutral wire connection required.
- 0-10V DC Low Voltage Dimmers operate using two low voltage dimming wires that are separate from the 120V or 277V AC power. The Dimmer sends a variable output voltage to the fixture based upon the dimming level. 10V Corresponds to undimmed operation, 5V to 50% and so on. Switching on/off is controlled with the line voltage power input (120V or 277V AC) to the Dimmer and then dimming operation is controlled with the 0-10V DC low voltage wiring connection between the Dimmer and the LED Driver. The control signal runs on two low voltage control wires (color coded violet and pink/gray).
- Lutron EcoSystem Drivers provide continuous dimming from 1%-100%. For a complete list of compatible dimmers and controls, please visit www.lutron.com

			CY3S/CY3T* Dimming Option 12D1 or MVD2
Manufacturer	Product	Model	Light Output
Leviton	IllumaTech	IPI06-1LZ	1%-100%
Leviton	SureSlide	6631-2	1%-100%
Leviton	Vizia	VPE06	9%-100%
Leviton	Trimatron	6683-IW	4%-100%
Leviton	Decora	6161	15%-100%
Leviton	SureSlide	6633-P	0%-100%
Leviton	IllumaTech	IPE04	6%-100%
Leviton	IllumaTech	IP710-DLX	NA
Lutron	Ariadni	TGCL-153P	4%-100%
Lutron	Ariadni	TG-600P	11%-100%
Lutron	Diva	DVCL-153P	0%-100%
Lutron	Diva	DV600P	0%-100%
Lutron	Diva	DVELV303P	6%-100%
Lutron	Diva	DVTV	NA
Lutron	Faedra	FAELV500	12%-100%
Lutron	Lumea	LG600P	5%-100%
Lutron	Maestro	MAELV600	11%-100%
Lutron	Nova	NFTV	NA
Lutron	Nova T	NTFTV	NA
Lutron	Skylark	S-603PG	4%-96%
Lutron	Skylark	S600P	1%-100%
Lutron	Skylark	SELV300P	7%-100%
Lutron	Skylark	CT103P	9%-100%
Pass & Seymour	Titan	CD4FB-W	NA
Watt Stopper	Miro Decorator	DCLV1	NA
Synergy		ISD BC	NA
Cooper	Devine	DLC03P	1%-100%
Cooper	Skye	SLC03P	0%-100%
Cooper	Decorator	DAL06P	0%-100%

*277V Triac Dimming is not available

1. Testing was performed with a single fixture connected to dimmer.
2. Testing has been performed on these dimmers, but this does not imply any warranty of compatibility.
3. Dimming performance can be influenced by different loads, as well as variations in dimmer switches within the same model.
4. Dimmer maximum load rating with LED may differ from published traditional source dimmer ratings. Consult manufacturer for maximum dimmer information.
5. Consult factory for additional dimming information.