

DATE

PROJECT

TYPE

RN2RM | 2" LED Trimless Downlight: New Construction and Remodel Housing

WATTAGE	8W	10W	14W
LUMEN OUTPUT ¹	800Lm	1100Lm	1400Lm
BEAM SPREAD	12° Spot/27° Medium/40° Flood/65° Wide Flood/Wall Wash		
COLOR TEMPERATURE	2700K/3000K/3500K/4000K		
CRI	83 (80min) / 90+		
SYSTEM RATING	50,000 Hours @ 70% Lumen Maintenance		
DRIVER INPUT WATTAGE	8W	10W	14W
DRIVER INPUT CURRENT (A) 120/277	.07/.03	.08/.04	.12/.05
DRIVER INPUT VOLTAGE Dimming (Triac, ELV, 0-10V) Lutron EcoSystem® Dimming	90-305V AC, 50/60Hz 120-277V AC, 50/60Hz		
DRIVER Power Factor THD	> 0.90 < 20%		
LISTING	cCSAus Certified using US (UL) and Canadian (CSA) standards Housings with S, M, F, and WF beam distributions are suitable for wet locations with any trim; Wall Wash (WW) housing is only suitable for wet locations with CTRN2323L trims Conforms to Washington State Energy Code (WSEC) for low air infiltration. Tested in accordance with ASTM E283 CP Housing is Chicago Plenum CCEA listed Assembled in the USA		
WARRANTY	Five (5) Year Replacement After Date of Purchase		

1. Lumen values are approximate, see page 5 for photometric test results



Ceiling Thickness: 1/2" - 1"

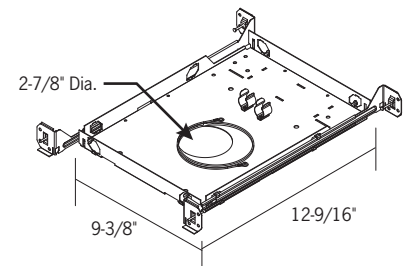
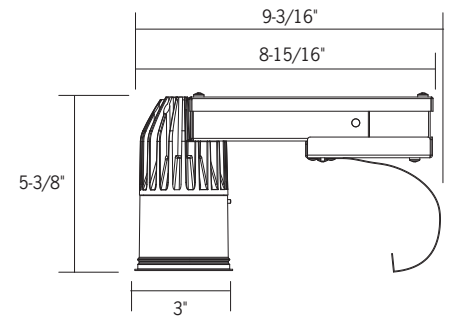

Optional Mounting Frame: NCF1

RN2RM | 2" LED Trimless Downlight: New Construction and Remodel Housing

Ordering Information

Housing + Mud Frame + Trim = Complete System

Example Order Housing: Mud Frame:
Trim:

Housing	LED Series	Color Temp/CRI	Electrical/Dimming	Beam Distribution	Options
RN2RM	05 - 8W, 800lm, IC, Stopaire Remodel 1 - 10W, 1100lm, IC, Stopaire Remodel 2¹ - 14W, 1400lm, Non-IC, Stopaire Remodel	83 (80min) CRI 27K - 2700K 30K - 3000K 35K - 3500K 40K - 4000K 90 CRI 27KC - 2700K 30KC - 3000K 35KC - 3500K 40KC - 4000K	MVD² - 120/277V Triac, ELV and 0-10V Dimming MVD4 - Lutron Hi-lume 1% EcoSystem LED Driver with Soft-on, Fade-to-Black	S - 12° Spot M - 27° Medium F - 40° Flood WF - 65° Wide Flood WW - Wall Wash <i>For use with CTR2323L trims</i>	CP - Chicago Plenum

1. Series 2 is not available for use in Insulated Ceilings (IC)
2. 120V TRIAC and ELV dimming only

Replacement Optics and Accessories

Standard Hanger Bars Supplied with Housing

- 2INOPTIC-S-RA2** - Spot Beam Replacement Optic
- 2INOPTIC-M** - Medium Beam Replacement Optic
- 2INOPTIC-F** - Flood Beam Replacement Optic
- 2INOPTIC-WF** - Wide Flood Beam Replacement Optic
- NCF1** - New Construction Mounting Frame
- RL-KIT** - Commercial Mounting Brackets, used with NCF1
- HB-24** - 27" Flat Hanger Bars for RL-KIT
- HBC-24** - 25" C-Channel Hanger Bars for RL-KIT in Grid Ceiling Construction
- HB-30** - T-Bar Hanger Set, used with NCF1

Mud Frame

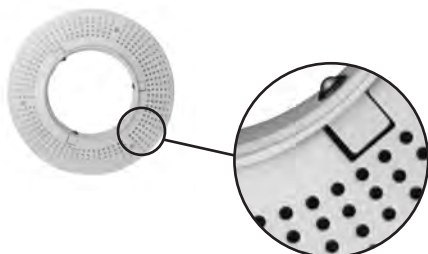

MF2

2" Mud Frame

Required - Order Separately

OD: 6-1/4"

Die-cast ring with steel mesh frame, painted white.

DATE

PROJECT

TYPE

RN2RM | 2" LED Trimless Downlight: New Construction and Remodel Housing

Trims



CSTN2322L-CLR
Anodized Clear Trimless Reflector



CSTN2322L-PL
Anodized Platinum Trimless Reflector



CTR2323L-CLR
Anodized Clear Specular Trimless Wall Wash



CTR2323L-PL
Anodized Platinum Trimless Wall Wash



CSTN2322L-BLK
Matte Black Painted Trimless Reflector



CSTN2322L-WHT
Matte White Painted Trimless Reflector



CTR2323L-BLK
Matte Black Painted Trimless Wall Wash



CTR2323L-WHT
Matte White Painted Trimless Wall Wash

CSTN2322L Series
Specification Grade Trimless Full Cone Reflector
OD: 2-15/16"; ID 2-1/2"

Trim is wet location certified without the need for lensing. Accepts one (1) FA-16 60MM 2-3/8" Dia. Black Honeycomb Louver or (1) LF16 60MM 2-3/8" Dia. Tempered Glass Lens.

CTR2323L Series
Trimless Wall Wash Reflector
OD: 2-15/16"; ID 2-5/16"

Angled TIR optic enables precise light control. Cannot be used with lenses or louvers.

2-3/8" Dia. Lenses/Louver

FA-16 60MM - Honeycomb Louver

LF16- 60MM** - 2-3/8" Diameter Lenses

**Color/Pattern Legend

-A (Amber), -B (Blue), -CL (Clear), -DPE (Dichroic Peach), -G (Green), -LB (Light Blue),
-R (Red), -RO (Rose), -Y (Yellow), -73 (Spread Lens), -LS (Linear Spread Lens),
-SL (Soft Light), -SOL (Solite), -UV (Optivex UV Filter)

RN2RM | 2" LED Trimless Downlight: New Construction and Remodel Housing

Features

- LED Series 05 (8W/800lm) and 1 (10W/1100lm) are Insulated Ceiling (IC), Stopaire housings; thermally protected for use in applications with direct contact with insulation materials
- LED Series 2 (14W/1400lm) is a Non-Insulated Ceiling (Non-IC), Stopaire housing, requiring minimum 3" clearance around housing from insulation material. Thermal protection provided in case of improper insulation use.
- Die-cast aluminum collar and heat sink, driver compartment and junction box made from 16-gauge steel. Housing has a black painted finish.
- LED Drivers are fully accessible from below the ceiling
- A metal perforated mud frame is required (MF2 ordered separately). When fastened to the ceiling, mud frame utilizes three spring and ball detent points to securely support housing.
- Minimum plenum clearance required to install housing in ceiling is 6"
- **NOTE:** Certain regions require the use of a housing mounting frame in conjunction with the RN2RM housing. The NCF1 new construction mounting frame should be specified when required (ordered separately).
- Pre-wired junction box with a convenient screwdriver pry-out. (1) 1/2" Pryout. A duplex electrical connector is provided to simplify daisy-chain wiring. Output over voltage, over-current and short circuit protection.
- Many trim options available to complement any design style. See ordering information for details.

Performance Summary

- Light engine consists of a high output multi-chip LED array arranged into a single LED package, enabling precise optical control without requiring lensing to diffuse multiple LED sources
- Precision TIR Optics produce 12°, 27°, 40°, and 65° beam distributions. Optics are interchangeable and can be field replaced.
- The Wall Wash housing/trim combination utilizes a unique angled TIR optic mounted to the trim to create a smooth, uniform beam distribution. Wall Wash housing is dedicated for use only with Wall Wash trim. There is no interchangeability with other housings or optics.
- Excellent fixture to fixture color consistency within a 2-step MacAdam Ellipse tolerance
- Driver with Class 2 output, RoHS Compliant
- All RN2RM downlights are available for non-dimming and dimming applications. For a list of compatible dimmers, refer to the Dimming Specifications sheet.
- cCSAus Certified using US (UL) and Canadian (CSA) standards
- Housings with S, M, F, and WF beam distributions are suitable for wet locations with any trim; Wall Wash (WW) housing is only suitable for wet locations with CTRN2323L series trims
- Conforms to Washington State Energy Code (WSEC) for low air infiltration; tested in accordance with ASTM E283 (2.0 CFM or less).
- CP Housing is Chicago Plenum CCEA listed
- Assembled in the USA

Warranty

- Complete fixture is covered by ConTech's full five (5) year replacement guarantee after date of purchase.

DATE

PROJECT

TYPE

RN2RM | 2" LED Trimless Downlight: New Construction and Remodel Housing

Photometrics

R2RM230KMVDF/CST2322L-CLR

Fixture Delivered Lumens: 1443
 Total Watts@120V: 13.9
 Lumens Per Watt: 103.8
 Center Beam Candle Power: 3974
 Beam Distribution: 36°
 Spacing Criterion: 0.60
 Color Rendering Index (CRI)¹: 84
 Color Temperature (CCT)²: 2941K
 Designed for 50,000 Hour Lamp Life³
 LM-63 Test No. G17030603
 LM-79 Test No. S17030603

Intensity Distribution		
DISTANCE (FT.)	FOOTCANDLES (FC)	BEAM DIAMETER (FT.)
6'	110.4	3.9
8'	62.1	5.2
10'	39.7	6.5
12'	27.6	7.8
14'	20.3	9.1
16'	15.5	10.4

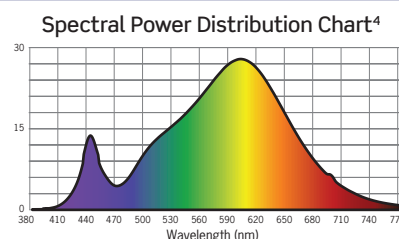
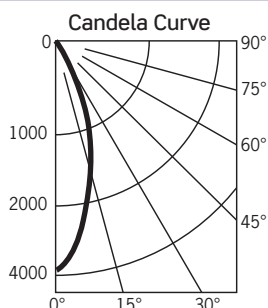

R2RM230KMVDM/CST2322L-CLR

Fixture Delivered Lumens: 1442
 Total Watts@120V: 13.9
 Lumens Per Watt: 103.7
 Center Beam Candle Power: 6569
 Beam Distribution: 27°
 Spacing Criterion: 0.44
 Color Rendering Index (CRI)¹: 84
 Color Temperature (CCT)²: 2934K
 Designed for 50,000 Hour Lamp Life³
 LM-63 Test No. G17030612
 LM-79 Test No. S17030612

Intensity Distribution		
DISTANCE (FT.)	FOOTCANDLES (FC)	BEAM DIAMETER (FT.)
6'	182.5	2.9
8'	102.6	3.9
10'	65.7	4.8
12'	45.6	5.8
14'	33.5	6.8
16'	25.7	7.7

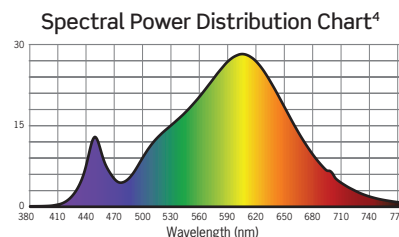
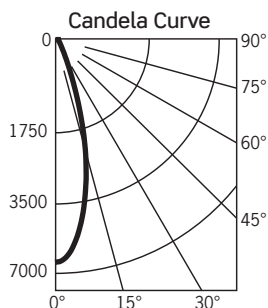

R2RM230KMVDS/CST2322L-CLR

Fixture Delivered Lumens: 1200
 Total Watts@120V: 13.9
 Lumens Per Watt: 86.3
 Center Beam Candle Power: 13157
 Beam Distribution: 14°
 Spacing Criterion: 0.27
 Color Rendering Index (CRI)¹: 84
 Color Temperature (CCT)²: 2939K
 Designed for 50,000 Hour Lamp Life³
 LM-63 Test No. G17030704
 LM-79 Test No. S17030704

Intensity Distribution		
DISTANCE (FT.)	FOOTCANDLES (FC)	BEAM DIAMETER (FT.)
6'	365.5	1.5
8'	205.6	2.0
10'	131.6	2.5
12'	91.4	3.0
14'	67.1	3.4
16'	51.4	3.9

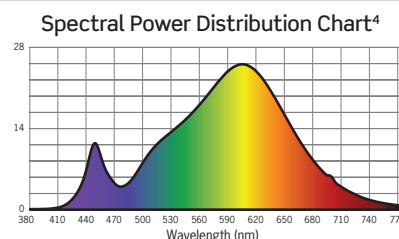
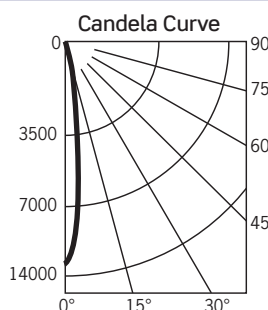

1. Accuracy of rendering colors 2. Color appearance of light source 3. Dependent on surrounding temperatures 4. Colors present within the light source

Photometric Multiplication Factors

Lumen output values fluctuate based on CCT. To estimate lumen output of the various CCT options, multiply 3000K results by the following:

CCT	STANDARD CRI	HIGH CRI	SERIES 05, 8W	SERIES 1, 10W	WHT/PL/PLWHE REFL	BLK REFL
2700K	0.94	0.70	0.61	0.74	1.0	0.94
3000K	N/A	0.75	0.61	0.74	1.0	0.94
3500K	1.0	0.81	0.61	0.74	1.0	0.94
4000K	1.0	0.87	0.61	0.74	1.0	0.94

RN2RM | 2" LED Trimless Downlight: New Construction and Remodel Housing

Photometrics

R2RM230KMVDWF/CST2322L-CLR

Fixture Delivered Lumens: 1229
 Total Watts@120V: 13.9
 Lumens Per Watt: 87.2
 Center Beam Candle Power: 1179
 Beam Distribution: 65°
 Spacing Criterion: 0.97
 Color Rendering Index (CRI)¹: 84
 Color Temperature (CCT)²: 2941K
 Designed for 50,000 Hour Lamp Life³
 LM-63 Test No. G17071105

Intensity Distribution		
DISTANCE (FT.)	FOOTCANDLES (FC)	BEAM DIAMETER (FT.)
6'	365.5	1.5
8'	205.6	2.0
10'	131.6	2.5
12'	91.4	3.0
14'	20.2	3.4
16'	51.4	4.6

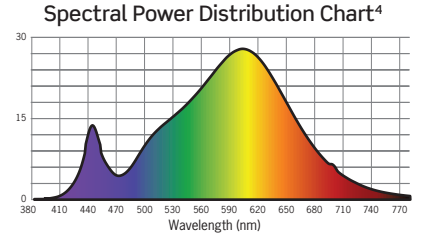
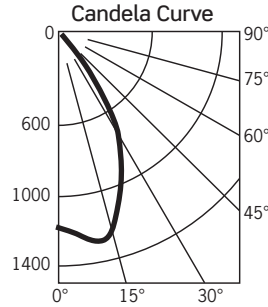

1. Accuracy of rendering colors 2. Color appearance of light source 3. Dependent on surrounding temperatures 4. Colors present within the light source

Photometric Multiplication Factors

Lumen output values fluctuate based on CCT. To estimate lumen output of the various CCT options, multiply 3000K results by the following:

CCT	STANDARD CRI	HIGH CRI	SERIES 05, 8W	SERIES 1, 10W	WHT/PL/PLWHE REFL	BLK REFL
2700K	0.94	0.70	0.61	0.74	1.0	0.94
3000K	N/A	0.75	0.61	0.74	1.0	0.94
3500K	1.0	0.81	0.61	0.74	1.0	0.94
4000K	1.0	0.87	0.61	0.74	1.0	0.94

DIMMING SPECIFICATIONS | R2RM, R2RMWD, RN2RM, RN2RMWD, R2SQRM, R2SQRMWD, RN2SQRM and RN2SQRMWD Series

- Incandescent 120VAC dimmers adjust the light with “forward phase control,” where the dimmer “chops” the forward part of the AC wave to deliver less or more power to the light source. No neutral wire connection required.
- Electronic low voltage 120VAC dimmers adjust the light with “reverse phase control,” where the dimmer “chops” the back part of the AC wave to deliver less or more power to the light source. Neutral wire connection required.
- 0-10V DC low voltage dimmers operate using two low voltage dimming wires that are separate from the 120V or 277V AC power. The dimmer sends a variable output voltage to the fixture based upon the dimming level. 10V corresponds to undimmed operation, 5V to 50% and so on. Switching on/off is controlled with the line voltage power (120V or 277V AC) input to the dimmer and then dimming operation is controlled with the 0-10V DC low voltage wiring connection between the dimmer and the LED driver. The control signal runs on two low voltage control wires (color coded violet and gray).

			R2RM*, RN2RM*, R2RMWD*, RN2RMWD* R2SQRM*, RN2SQRM*, R2SQRMWD*, RN2SQRMWD* Dimming Option MVD
Manufacturer	Product	Model	Light Output
Leviton	IllumaTech	IPI06-1LZ	1%-100%
Leviton	SureSlide	6631-2	1%-100%
Leviton	Renoir	AWSMT7	22%-100%
Leviton	Vizia	VPE06	9%-100%
Leviton	Trimatron	6683-IW	4%-100%
Leviton	Decora	6161	15%-100%
Leviton	SureSlide	6633-P	0%-100%
Leviton	IllumaTech	IPE04	6%-100%
Leviton	IllumaTech	IP710-DLX	NA
Cooper	Devine	DLC03P	1%-100%
Cooper	Skye	SLC03P	0%-100%
Cooper	Decorator	DAL06P	0%-100%
Pass & Seymour	Titan	CD4FB-W	NA
Synergy		ISD BC	NA
Watt Stopper	Miro Decorator	DCLV1	NA
Lutron	Ariadni	TGCL-153P	4%-100%
Lutron	Ariadni	TG-600P	11%-100%
Lutron	Diva	DVCL-153P	0%-100%
Lutron	Diva	DV600P	0%-100%
Lutron	Diva	DVELV303P	6%-100%
Lutron	Diva	DVTV	NA
Lutron	Diva	DVSTWH	8%-100%
Lutron	Faedra	FAELV500	12%-100%
Lutron	Lumea	LG600P	5%-100%
Lutron	Maestro	MAELV600	11%-100%
Lutron	Nova	NFTV	NA
Lutron	Nova T	NFTTV	NA
Lutron	Skylark	S-603PG	4%-96%
Lutron	Skylark	S600P	1%-100%
Lutron	Skylark	SELV300P	7%-100%
Lutron	Skylark	CT103P	9%-100%

*277V Triac and ELV dimming is not available

Notes

1. Testing was performed with a single fixture connected to dimmer.
2. Testing has been performed on these dimmers, but this does not imply any warranty of compatibility.
3. Dimming performance can be influenced by different loads, as well as variations in dimmer switches within the same model.
4. Dimmer maximum load rating with LED may differ from published traditional source dimmer ratings. Consult manufacturer for maximum dimmer information.
5. Consult factory for additional dimming information.