

DATE

PROJECT



TYPE

R4SQRM SERIES | 4-Inch Square Remodel Downlight Housing

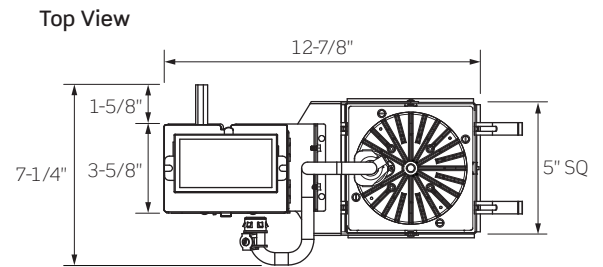
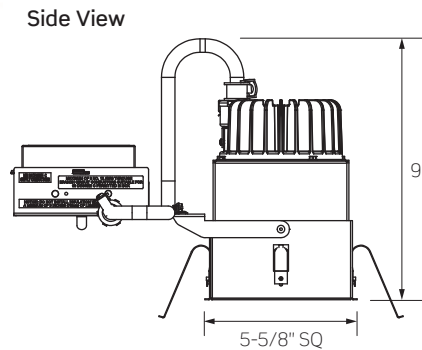

Ceiling Opening: 5-1/2"
Ceiling Thickness: 1/2" - 5/8"



	R4SQRM1	R4SQRM2	R4SQRM3	R4SQRM4	R4SQRM5	R4SQRM6
WATTAGE	12W	15W	21W	30W	38W	45W
LUMEN OUTPUT ¹	1100Lm	1600Lm	2200Lm	3000Lm	3700Lm	4100Lm
BEAM SPREADS	33° Narrow / 38° Medium / 62° Wide / Wall Wash					
COLOR TEMPERATURE	2700K / 3000K / 3500K / 4000K					
CRI	83 (80min) / 90+					
INPUT WATTAGE	12W	15W	21W	30W	38W	45W
INPUT CURRENT (A) 120V/277V/347V	.08/.04/.03	.12/.06/.04	.17/.08/.06	.23/.11/.08	.31/.14/.11	.36/.16/.12
INPUT VOLTAGE	120VAC / 277VAC / 347VAC, 50/60Hz					
Standard Driver	120VAC / 277VAC / 347VAC, 50/60Hz				N/A	N/A
Lutron Eco-System® Driver	120VAC / 277VAC, 50/60Hz				N/A	N/A
eldoLED ECOdrive / SOLOdrive	120VAC / 277VAC, 50/60Hz					
DRIVER POWER FACTOR	> 0.90					
TOTAL HARMONIC DISTORTION (THD)	< 20%					
LISTINGS	   cCSAus Certified to UL Standards; Suitable for Wet Locations except Wall Wash option ENERGY STAR® Certified: – Series 1 through 6, except High CRI 2700K Color Temperature (27KC Option) – Certified trims: C4322SQ (all finishes) – 347V Option, Lutron and eldoLED Dimming Options are not ENERGY STAR® Certified					
WARRANTY	Five (5) year replacement after date of purchase					
SYSTEM RATING	50,000 Hours @ 70% Lumen Maintenance					

1. Approximate lumen output based on 3000K performance; see photometric test results for additional information

DATE	PROJECT	TYPE
------	---------	------

R4SQRM SERIES | 4-Inch Square Remodel Downlight Housing

ORDERING INFORMATION

Example Order: -

Housing/LED Series	Color Temp/CRI	Electrical	Dimming	Beam Dist.
R4SQRM1 - 12W / 1100lm	83 (80min) CRI	12 - 120V	D¹ - TRIAC, ELV, 0-10V	N - 33° Narrow
R4SQRM2 - 15W / 1600lm	27K - 2700K	27 - 277V	D2² - 347V 0-10V	M - 38° Medium
R4SQRM3 - 21W / 2200lm	30K - 3000K	34 - 347V	D4³ - Lutron Hi-lume 1% EcoSystem Driver with Soft-on, Fade-to-Black	W - 62° Wide
R4SQRM4 - 30W / 3000lm	35K - 3500K		D6⁴ - eldoLED ECOdrive 0-10V, 1% Dimming	WW - Wall Wash
R4SQRM5 - 38W / 3700lm	40K - 4000K		D7⁴ - eldoLED ECOdrive DALI, 1% Dimming	
R4SQRM6 - 45W / 4100lm	90+ CRI		D8⁴ - eldoLED SOLOdrive 0-10V, 0.1% Dimming	
	27KC - 2700K		D9⁴ - eldoLED SOLOdrive DALI, 0.1% Dimming	
	30KC - 3000K		DMX^{4,5} - eldoLED POWERdrive DMX 0.0% Dimming	
	35KC - 3500K			
	40KC - 4000K			

1. TRIAC and ELV Dimming for 120V only
2. Only available for 347V Electrical option (34)
3. Lutron Eco-System Driver is available for both 120V and 277V, Series 1 through 4 only (12W through 30W); not available for use with LED Series 5 or 6 (38W or 45W)
4. eldoLED Drivers are programmed for linear curve dimming as standard. For Logarithmic Curve Dimming, consult factory
5. Verify DMX Driver and Control System compatibility with factory prior to ordering

REPLACEMENT OPTIC ORDERING INFORMATION

Replacement Optics

- 4SQOPT-N** - 33° Beam Replacement Optic
- 4SQOPT-M** - 38° Beam Replacement Optic
- 4SQOPT-W** - 62° Beam Replacement Optic

See “Trims for 4-Inch Square Downlights” Specification Sheet for compatible Trim information and details

PRODUCT DETAILS

Construction

- Specification Grade 4-inch Square 16 Gauge Galvanized Steel Remodel Housing with Die-Cast Aluminum Heat Sink
- Requires minimum 3-inch clearance around Housing from insulation material; thermal protection provided in case of improper insulation use
- Heavy Duty Steel Flange secured to ceiling by four (4) Spring Clamps
- Quick-connect Light Engine
- LED Drivers are fully accessible from below the ceiling
- Pre-wired Junction Box with four (4) 1/2-inch Knockouts
- Output over-voltage, over-current and short circuit protection
- Approved for Through Circuit Wiring: max. four (4) 12 AWG (2in/2out), wiring rated to 90°C

Performance Summary

- 2700K, 3000K, 3500K and 4000K Color Temperatures
- CRI of 80 min., 83 typical; high CRI of 90+ available; excellent fixture-to-fixture color consistency with a 3-step MacAdam Ellipse tolerance
- Glass TIR Optics provide smooth, uniform beams; maximizing output and minimizing glare. Available in 33° Narrow, 38° Medium, and 62° Wide; optics are interchangeable and can be field replaced
- A high efficiency, soft-focus, field removable film is installed for even greater softening of the beam
- Wall Wash distribution provides a smooth, wide beam with excellent uniformity; well suited for any wall lighting application
- All R4SQ Downlights are available for non-dimming and dimming applications; for compatible Dimmers, refer to the Dimming Specification Sheet
- Flanged or Trimless Specification Grade Trims in several different styles and finishes available
- **Trimless options cannot be used on Remodel Style Housings**
- UL8750 and Class 2 Compliant; RoHS Compliant, US only

DATE	PROJECT	TYPE
------	---------	------

R4SQ SERIES | 4-Inch Square Downlight Trims

TRIMMED OPTIONS



C4322SQ-PL
Platinum Reflector



C4322SQ Series
Specification Grade Reflector

4-1/2-Inch SQ Aperture,
5-3/4-Inch SQ Trim Flange

Specification Grade Segmented
Reflectors. Wet Location approved.



C4322SQDC-SL
Satin Silver
Painted Reflector



C4322SQDC Series
*Die-Cast
Specification Grade Reflector*

C4322SQDF Series
ISOWET Dead Front Reflector

4-1/2-Inch SQ Aperture,
5-3/4-Inch SQ Trim Flange

Specification Grade Die-Cast Reflector or
Isolated Thermoplastic Reflector. Wet
Location approved.

C4322SQ - Specular Reflector

CLR¹ - Anodized Clear
PL¹ - Anodized Platinum
WHT - Matte White Painted

1. Available with White Painted
Flange: add -WPF to end of
part number

C4322SQDC - Die-Cast Reflector

C4322SQDF - ISOWET
Dead Front Reflector

SL¹ - Satin Silver Painted
WHT - Matte White Painted

1. Available with White Painted
Flange: add -WPF to end of
part number

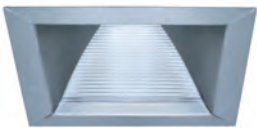

C4323SQ-PL
Anodized Platinum Wall Wash



C4323SQ Series
Lensed Wall Wash Trim

4-1/2-Inch SQ Aperture,
5-3/4-Inch SQ Trim Flange

Angled Diffuse Glass Spread Lens. Wet
Location approved.

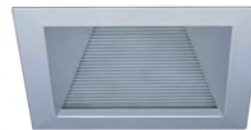

C4323SQDC-SL
Satin Silver Painted Wall Wash



C4323SQDC Series
Die-Cast Lensed Wall Wash Trim

4-1/2-Inch SQ Aperture,
5-3/4-Inch SQ Trim Flange

Lensed Wall Wash Trim. Wet Location
approved.

C4323SQ - Wall Wash

CLR¹ - Anodized Clear
PL¹ - Anodized Platinum
WHT - Matte White Painted

1. Available with White Painted
Flange: add -WPF to end of
part number

C4323SQDC - Die-Cast Wall Wash

SL¹ - Satin Silver Painted
WHT - Matte White Painted

1. Available with White Painted
Flange: add -WPF to end of
part number

DATE

PROJECT

TYPE

R4SQ SERIES | 4-Inch Square Downlight Photometrics

R4SQNC630K12DN / C4322SQ-CLR

Fixture Delivered Lumens: 4207.7
 Total Watts@120V: 44.7
 Lumens Per Watt: 94.1
 Center Beam Candle Power: 11502
 Beam Distribution: 33.7°
 Spacing Criterion: 0.55
 Color Rendering Index (CRI)¹: 83.3
 Color Temperature (CCT)²: 3053K
 Designed for 50,000 Hour Lamp Life³
 LM-63 Test No. G21072004
 LM-79 Test No. S21071503

DISTANCE (FT.)	FOOTCANDLES (FC)	BEAM DIAMETER (FT.)
6 FT	319.5	3.6
8 FT	179.7	4.8
10 FT	115.0	6.0
12 FT	79.9	7.2
14 FT	58.7	8.4
16 FT	44.9	9.7

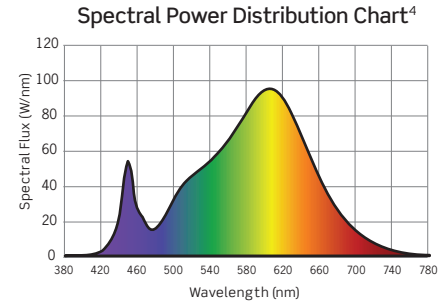
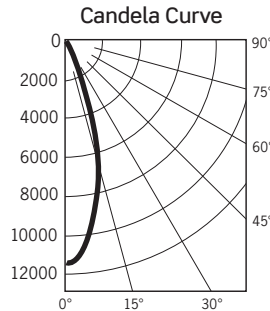

R4SQNC630K12DM / C4322SQ-CLR

Fixture Delivered Lumens: 4454.1
 Total Watts@120V: 44.7
 Lumens Per Watt: 99.6
 Center Beam Candle Power: 8124
 Beam Distribution: 38.0°
 Spacing Criterion: 0.61
 Color Rendering Index (CRI)¹: 83.3
 Color Temperature (CCT)²: 3053K
 Designed for 50,000 Hour Lamp Life³
 LM-63 Test No. G21071405
 LM-79 Test No. S21071503

DISTANCE (FT.)	FOOTCANDLES (FC)	BEAM DIAMETER (FT.)
6 FT	225.7	4.2
8 FT	126.9	5.6
10 FT	81.2	7.0
12 FT	56.4	8.4
14 FT	41.4	9.9
16 FT	31.7	11.3

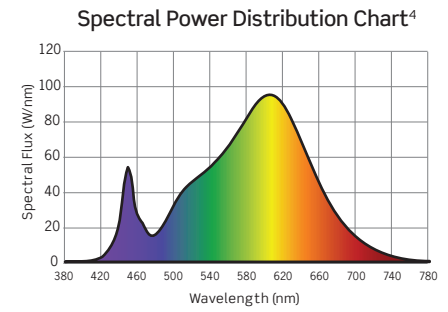
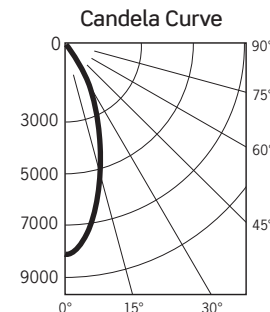

R4SQNC630K12DW / C4322SQ-CLR

Fixture Delivered Lumens: 4295.6
 Total Watts@120V: 44.7
 Lumens Per Watt: 96.1
 Center Beam Candle Power: 3684
 Beam Distribution: 61.7°
 Spacing Criterion: 1.0
 Color Rendering Index (CRI)¹: 8/3
 Color Temperature (CCT)²: 3053K
 Designed for 50,000 Hour Lamp Life³
 LM-63 Test No. G21071403
 LM-79 Test No. S21071503

DISTANCE (FT.)	FOOTCANDLES (FC)	BEAM DIAMETER (FT.)
6 FT	102.3	7.2
8 FT	57.6	9.6
10 FT	36.8	11.9
12 FT	25.6	14.3
14 FT	18.8	16.7
16 FT	14.4	19.1

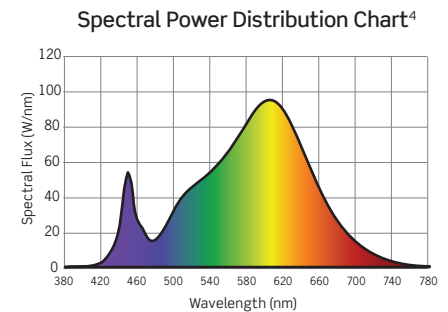
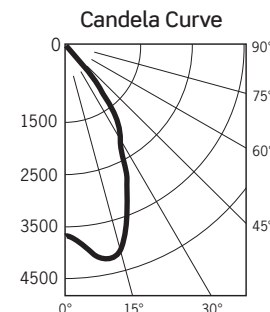

1. Accuracy of Rendering Colors 2. Color Appearance of Light Source 3. Dependent on Surrounding Temperatures 4. Colors Present within the Light Source

PHOTOMETRIC MULTIPLICATION FACTORS

Lumen output values fluctuate based on Color Temperature, Luminaire Wattage/Output and Trim Selection. To estimate lumen output of these various options, multiply 3000K results by the following:

CCT MULTIPLIERS			OUTPUT MULTIPLIERS					TRIM MULTIPLIERS	
CCT	STD CRI	HIGH CRI	SERIES 1	SERIES 2	SERIES 3	SERIES 4	SERIES 5	C4322SQDC-SL	C4322SQDF-SL
2700K	0.94	0.70	0.27	0.37	0.52	0.71	0.88	0.93	0.94
3000K	N/A	0.75							
3500K	1.0	0.81							
4000K	1.0	0.87							

DATE

PROJECT

TYPE

R4SQ SERIES | 4-Inch Square Downlight Photometrics

TM-30 DATA: R4SQNC630K12DM / C4322SQ-CLR

ANSI/IES TM-30-18 Color Rendition Report Test No. S21071503

Colors are for visual orientation purposes only

R_f	86
R_g	97
CCT(K)	3053K
D_{uv}	0.0014
u^l	0.2482
v^l	0.5223

Color Vector Graphic

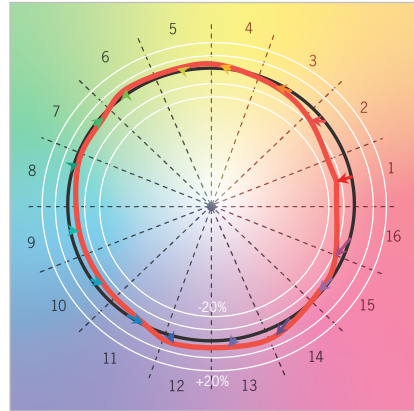

— Reference Illuminance — Test Source

Spectral Power Distribution Comparison

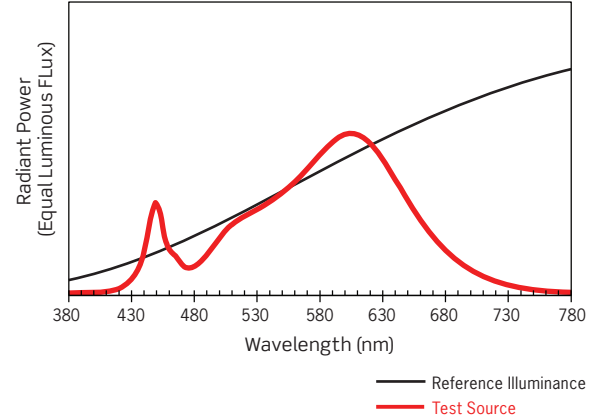

— Reference Illuminance
— Test Source

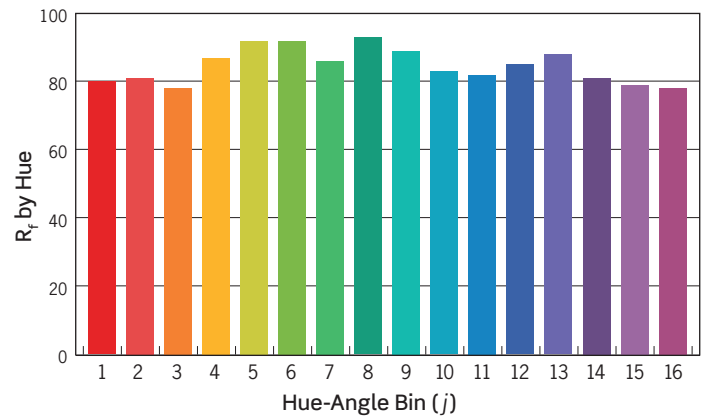
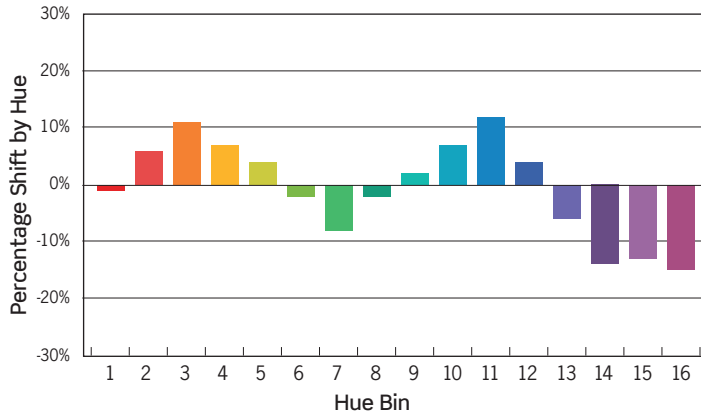

HUE BIN	1	2	3	4	5	6	7	8	9	10	11	12	13	14	15	16
HUE SHIFT	-1%	6%	11%	7%	4%	-2%	-8%	-2%	2%	7%	12%	4%	-6%	-14%	-13%	-15%
R _f VALUE	81	82	79	88	93	93	87	94	90	84	83	86	89	82	80	79

DATE

PROJECT

TYPE

R4SQ SERIES | 4-Inch Square Downlight Dimming Specifications

- Incandescent 120V AC Dimmers adjust the light with *Forward Phase Control*, where the Dimmer “chops” the forward part of the AC Wave to deliver less or more power to the light source. No Neutral Wire Connection required.
- Electronic Low Voltage 120V AC Dimmers adjust the light with *Reverse Phase Control*, where the Dimmer “chops” the back part of the AC Wave to deliver less or more power to the light source. Neutral Wire Connection required.
- 0–10V DC Low Voltage Dimmers operate using two (2) Low Voltage Dimming Wires that are separate from the 120V or 277V AC Power. The Dimmer sends a Variable Output Voltage to the luminaire based upon the dimming level. 10V Corresponds to undimmed operation, 5V to 50% and so on. Switching On/Off is controlled with the Line Voltage Power Input to the Dimmer (120V or 277V AC). Dimming operation is controlled with the 0–10V DC Low Voltage Wiring Connection between the Dimmer and the LED Driver. The Control Signal runs on two (2) low voltage control wires color coded Violet and Pink/Grey.
- Lutron EcoSystem Drivers provide continuous dimming from 1%–100%. For a complete list of compatible Dimmers and Controls, visit www.lutron.com
- Use DALI approved Controls for dimming eldoLED ECOdrive, 1% Dimming (Dimming Option D7 or MVD7) and eldoLED SOLOdrive, 0.1% Dimming (Dimming Option D9 or MVD9).

			TRIAC, ELV, 0-10V DIMMING (12D, 27D or MVD Option*)	eldoLED ECOdrive 0-10V (12D6, 27D6 or MVD6 Option)	eldoLED SOLOdrive 0-10V (12D8, 27D8 or MVD8 Option)
Manufacturer	Product	Model	Light Output	Light Output	Light Output
Leviton	IllumaTech	IPI06-1LZ	1%-100%	NA	NA
Leviton	SureSlide	6631-2	1%-100%	NA	NA
Leviton	Vizia	VPE06	9%-100%	NA	NA
Leviton	Trimatron	6683-IW	6%-100%	NA	NA
Leviton	Decora	6161	15%-100%	NA	NA
Leviton	SureSlide	6633-P	1%-100%	NA	NA
Leviton	IllumaTech	IPE04	6%-100%	NA	NA
Leviton	IllumaTech	IP710-DLX	NA	1%-100%	0.1%-100%
Cooper	Devine	DLC03P	1%-100%	NA	NA
Cooper	Skye	SLC03P	0%-100%	NA	NA
Cooper	Decorator	DAL06P	0%-100%	NA	NA
Pass & Seymour	Titan	CD4FB-W	NA	1%-100%	0.1%-100%
Synergy		ISD BC	NA	1%-100%	0.1%-100%
Watt Stopper	Miro Decorator	DCLV1	NA	1%-100%	0.1%-100%
Lutron	Ariadni	TGCL-153P	1%-100%	NA	NA
Lutron	Ariadni	TG-600P	13%-100%	NA	NA
Lutron	Diva	DVCL-153P	1%-100%	NA	NA
Lutron	Diva	DV600P	6%-100%	NA	NA
Lutron	Diva	DVELV303P	6%-100%	NA	NA
Lutron	Diva	DVTV	NA	1%-100%	0.1%-100%
Lutron	Faetra	FAELV500	12%-100%	NA	NA
Lutron	Lumea	LG600P	8%-100%	NA	NA
Lutron	Maestro	MAELV600	16%-100%	NA	NA
Lutron	Nova	NFTV	NA	1%-100%	0.1%-100%
Lutron	Nova T	NTFTV	NA	1%-100%	0.1%-100%
Lutron	Skylark	S-603PG	5%-96%	NA	NA
Lutron	Skylark	S600P	5%-100%	NA	NA
Lutron	Skylark	SELV300P	10%-100%	NA	NA
Lutron	Skylark	CT103P	9%-100%	NA	NA

*277V Triac Dimming is not available

NOTES

1. Testing was performed with a single luminaire connected to Dimmer.
2. Testing has been performed on these Dimmers, but this does not imply any warranty of compatibility.
3. Dimming performance can be influenced by different Loads, as well as variations in Dimmer Switches within the same Model.
4. Dimmer Maximum Load Rating with LED may differ from published Traditional Source Dimmer Ratings. Consult manufacturer for maximum Dimmer information.
5. Consult factory for additional dimming information.