

DATE

PROJECT

TYPE

R6SA KB SERIES | 6-Inch StopAire™ Housing with BIOS SkyBlue™ Technology



Ceiling Opening: 6-5/8"
Ceiling Thickness: 1/2" - 2"

Side View

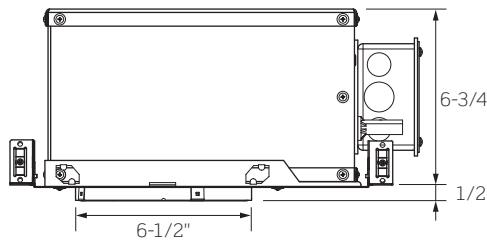

Bottom View

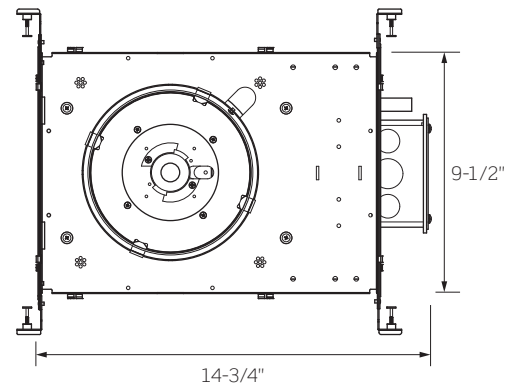

	R6SA1	R6SA2	R6SA3	R6SA4	R6SA5
WATTAGE	12W	15W	21W	30W	39W
LUMEN OUTPUT ¹	700Lm	900Lm	1300Lm	1800Lm	2200Lm
COLOR TEMPERATURE / CRI / R9	3000K / 81 CRI / 90 R9 3500K / 83 CRI / 95 R9 4000K / 83 CRI / 95 R9				
INPUT WATTAGE	12W	16W	21W	30W	38W
INPUT CURRENT (A) 120V/277V/347V	.08/.04/.03	.12/.06/.04	.17/.08/.06	.23/.11/.08	.31/.14/.11
INPUT VOLTAGE	120V - 277V Standard Driver 90-305V AC, 50/60Hz 347V Standard Driver 347V AC, 50/60Hz Lutron Eco-System® Driver 120VAC / 277VAC, 50/60Hz eidoLED ECOdrive / SOLOdrive 120VAC / 277VAC, 50/60Hz				
DRIVER POWER FACTOR	> 0.90				
TOTAL HARMONIC DISTORTION (THD)	< 20%				
LISTINGS	cCSAus Certified to UL Standards; Suitable for Damp Locations Conforms to Washington State Energy Code (WSEC) for Low Air Infiltration; tested in accordance with ASTM E283 (2.0 CRM or less) Chicago Plenum CCEA Listed				
WARRANTY	Five (5) year replacement after date of purchase				
SYSTEM RATING	50,000 Hours @ 70% Lumen Maintenance				

1. Approximate lumen output based on 3000K performance; see photometric test results for additional information

DATE	PROJECT	TYPE
------	---------	------

R6SA KB SERIES | 6-Inch StopAire™ Housing with BIOS SkyBlue™ Technology

ORDERING INFORMATION

Example Order: R6SA130KB12DBT

Housing/LED Series	Color Temp	Electrical	Dimming	BIOS Protocol
R6SA1 - 12W/700lm	30KB - 3000K	12 - 120V	D² - 120 - 277V TRIAC/ELV/0 - 10V	BT - BIOS Tunable Dimming
R6SA2 - 15W/900lm	35KB - 3500K	27 - 277V	D2 - 347V 0 - 10V Dimming	BS - BIOS Static Dimming
R6SA3 - 21W/1300lm	40KB - 4000K	34¹ - 347V	D4³ - Lutron Hi-lume 1% EcoSystem with Soft-on, Fade-to-Black	
R6SA4 - 30W/1800lm			D6⁴ - 120 - 277V eldoLED ECOdrive 0 - 10V, 1% Dimming	
R6SA5 - 39W/2200lm			D7⁴ - 120 - 277V eldoLED ECOdrive DALI, 1% Dimming	
			D8⁴ - 120 - 277V eldoLED SOLOdrive 0 - 10V, 0.1% Dimming	
			D9⁴ - 120 - 277V eldoLED SOLOdrive DALI, 0.1% Dimming	

1. 347V Electrical only available with 347V 0-10V Dimming Option (D2)
2. TRIAC and ELV Dimming for 120V only
3. Lutron Eco-System available for both 120V and 277V. Lutron dimming is available for Series 1 through 4 only (12W through 30W); not available for use with LED Series 5 (39W).
4. eldoLED Drivers are programmed for Linear Curve Dimming as standard; for Logarithmic Curve Dimming, consult factory

Accessories
Standard Hanger Bars Supplied with Housing
HB-30 - T-Bar Hanger Set

**See “Trims for 6-Inch BIOS Downlights”
 Specification Sheet for compatible Trim
 information and details**

DATE

PROJECT

TYPE

R6SA KB SERIES | 6-Inch StopAire™ Housing with BIOS SkyBlue™ Technology

PRODUCT DETAILS

Construction

- 6-Inch Specification Grade 16 Gauge Galvanized Steel StopAire™ Housing with Die-Cast Aluminum Heat Sink
- Quick Connect Light Engine; Drivers are fully accessible from below the ceiling
- Dual Nailer Hanger Bars are adjustable for 16- and 24- inch center joists (14-1/4 to 24-1/2 inch). Nailer Bars may be extended to rest on T-Bar ceilings; optional clip-on T-Bar Hangers available.
- Pre-wired Junction Box with eight (8) 1/2- inch and four (4) 3/4- inch KO's
- Output over-voltage, over-current and short circuit protection
- Approved for Through Circuit Wiring: max. eight (8) 12 AWG (4in/4out), wiring rated to 90°C
- Requires minimum 3- inch clearance around Housing from insulation material; thermally protected in case of improper insulation use

Performance Summary

- All R4 Downlights are available for non-dimming and dimming applications; for compatible Dimmers, refer to the Dimming Specification Sheet
- Flanged or Trimless Specification Grade Trims; See "Trims for 6-Inch BIOS LED Recessed Downlights" Specification Sheet for compatible trim information and details
- Trimless options require use of a Mud Frame (MF6, ordered separately) for securing housing and trim in 1/2- to 1- inch thick ceilings only
- Trimless options cannot be used with Remodel Housings (R6RM) or Slope Ceiling Adapters (RSA6L Series)
- UL8750 and Class 2 Compliant; RoHS Compliant, US only

BIOS SKYBLUE LED TECHNOLOGY DETAILS

- BIOS SkyBlue™ Circadian Lighting Technology brings the benefits of blue skies inside by emulating the makeup of nature's light spectrum.
- Light sends signals to the body that create biological responses, many associated with the body's circadian system. These responses impact mood, hormone production, energy levels, alertness, fatigue and more.
- This biological response to light can be measured by the melanopic (non-visual) to photopic (visible) ratio called the M/P ratio. During the day, a high M/P ratio is optimal, while at night a low M/P ratio is best.
- BIOS LEDs provide high daytime stimulus by pin-pointing the peak sensitivity of the "sky blue" visible light spectrum wavelengths, approx. 490nm, needed to effectively communicate and trigger circadian response.

			MELANOPIC RATIO (M/P) ¹	
CCT	CRI	R9	DAY	NIGHT ²
3000K	81	90	0.74	0.47
3500K	83	95	0.83	0.47
4000K	83	95	0.92	0.47

1. The Melanopic Ratios (M/P) provided have been calculated using the WELL v2 Methodology
2. 2700K CCT with SkyBlue (490nm) removed during Nighttime. Available only for Tunable BioDimming™, not available for Static BioDimming™

BIOS BIO-DIMMING™

The BIOS Bio-Dimming Modules deliver a completely customizable and spectrally-modulated light source. Two Modules are available, Tunable or Static, depending on desired performance, and can be used with any standard dimming interface.

Tunable Bio-Dimming™ is best suited for 24-hour facilities or evening applications, where full light output is desired as the day progresses, but also there is also the need to minimize circadian impact in the evening.

When dimming, the sky blue wavelengths are removed first, resulting in a modest color temperature shift to 2700K. This occurs within the first 20% of the dimming profile, the remainder of the dimming profile reduces light output, providing a standard linear reduction of the sky blue depleted spectrum.

TUNABLE BIO-DIMMING PROTOCOL			
DIMMER LEVEL	CCT	SKYBLUE %	LIGHT OUTPUT
100%	Initial CCT 3000K/3500K/4000K	100%	100%
99% - 81%	Gradual Shift down to 2700K	100% - 0%	100%
80%	2700K	0% No SkyBlue Wavelengths	100%
79% - 0%	2700K	0% No SkyBlue Wavelengths	Linear Dimming

Static Bio-Dimming™ supports proper daytime circadian stimulus, best suited for day-only applications.

A steady, invisible, sky blue signal boost to white light is delivered throughout the day for high daytime circadian stimulus. When dimming, these sky blue wavelengths remain as overall light intensity is dimmed down.

STATIC BIO-DIMMING PROTOCOL			
DIMMER LEVEL	CCT	SKYBLUE %	LIGHT OUTPUT
100%	Initial CCT 3000K/3500K/4000K	100%	100%
99% - 0%	Initial CCT 3000K/3500K/4000K	100%	Linear Dimming

DATE

PROJECT

TYPE

R6 KB SERIES | 6-Inch Downlights with BIOS SkyBlue™ Technology Photometrics

PHOTOMETRICS

R6*535KB12DBS / C6322M-CLR: 6-Inch Downlight, Medium Beam, Clear Reflector

LM-63 Test No. G21093001; LM-79 Test No. S21093001

Fixture Delivered Lumens: 2219.2
 Total Watts@120V: 38.5
 Lumens Per Watt: 57.6
 Center Beam Candle Power: 2069
 Beam Distribution: 67.8°
 Spacing Criterion: 0.98
 Color Rendering Index (CRI)1: 84.8
 Color Temperature (CCT)2: 3238K
 Peak Sensitivity: 490nm
 R9 Value: 93.3
 Designed for 50,000 Hour Lamp Life³

DISTANCE (FT.)	FOOTCANDLES (FC)	BEAM DIA. (FT.)
6 FT	57.5	8.1
8 FT	32.3	10.8
10 FT	20.7	13.5
12 FT	14.4	16.1
14 FT	10.6	18.8
16 FT	8.1	21.5

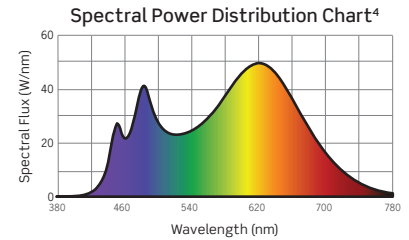
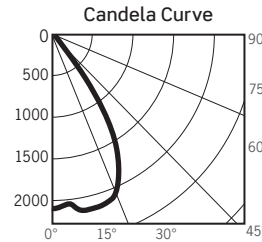

R6*535KB12DBS / C6322W-CLR: 6-Inch Downlight, Wide Beam, Clear Reflector

LM-63 Test No. G21093002; LM-79 Test No. S21093001

Fixture Delivered Lumens: 2296.7
 Total Watts@120V: 38.5
 Lumens Per Watt: 59.7
 Center Beam Candle Power: 1491
 Beam Distribution: 74.5°
 Spacing Criterion: 1.10
 Color Rendering Index (CRI)1: 84.8
 Color Temperature (CCT)2: 3238K
 Peak Sensitivity: 490nm
 R9 Value: 93.3
 Designed for 50,000 Hour Lamp Life³

DISTANCE (FT.)	FOOTCANDLES (FC)	BEAM DIA. (FT.)
6 FT	41.4	9.1
8 FT	23.3	12.2
10 FT	14.9	15.2
12 FT	10.4	18.3
14 FT	7.6	21.3
16 FT	5.8	24.3

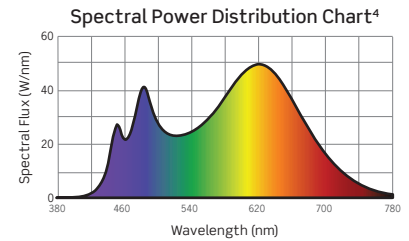
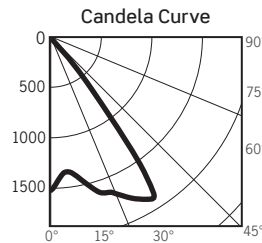

R6*535KB12DBS / C6322-PL: 6-Inch Downlight, Platinum Reflector

LM-63 Test No. G21093003; LM-79 Test No. S21093001

Fixture Delivered Lumens: 2267.3
 Total Watts@120V: 38.5
 Lumens Per Watt: 58.9
 Center Beam Candle Power: 2723
 Beam Distribution: 62.2°
 Spacing Criterion: 0.94
 Color Rendering Index (CRI)1: 84.8
 Color Temperature (CCT)2: 3238K
 Peak Sensitivity: 490nm
 R9 Value: 93.3
 Designed for 50,000 Hour Lamp Life³

DISTANCE (FT.)	FOOTCANDLES (FC)	BEAM DIA. (FT.)
6 FT	75.6	7.2
8 FT	42.5	9.7
10 FT	27.2	12.1
12 FT	18.9	14.5
14 FT	13.9	16.9
16 FT	10.6	19.3

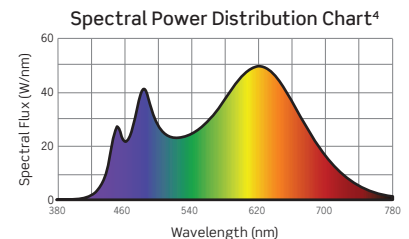
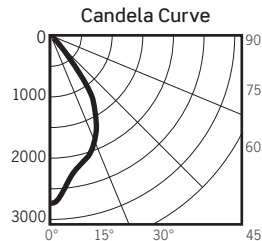

1. Accuracy of Rendering Colors 2. Color Appearance of Light Source 3. Dependent on Surrounding Temperatures 4. Colors Present within the Light Source

PHOTOMETRIC MULTIPLIERS

Lumen output values fluctuate based on Color Temperature (CCT), Color Rendering Index (CRI) and Wattage. To estimate lumen output of other combinations, multiply the published results by the following factors:

CCT	STANDARD CRI
3000K	0.95
3500K	N/A
4000K	1.05

SERIES 1	SERIES 2	SERIES 3	SERIES 4
0.31	0.43	0.61	0.81

C6322W-CLR	C6322-PL	C6322-WHT	C6323-CLR
1.03	1.02	0.91	0.74

DATE

PROJECT

TYPE

R6 KB SERIES | 6-Inch Downlights with BIOS SkyBlue™ Technology Photometrics

PHOTOMETRICS: TM-30 DATA

R6*535KB12DBS / C6322M-CLR

ANSI/IES TM-30-18 Color Rendition Report Test No. S21093001

R_f	86
R_g	96
CCT(K)	3238K
D_{uv}	-0.0098
u^l	0.2469
v^l	0.5031

Color Vector Graphic

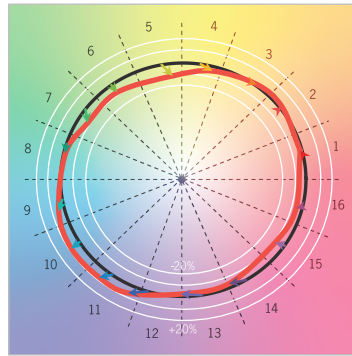

— Reference Illuminance
— Test Source

Spectral Power Distribution Comparison

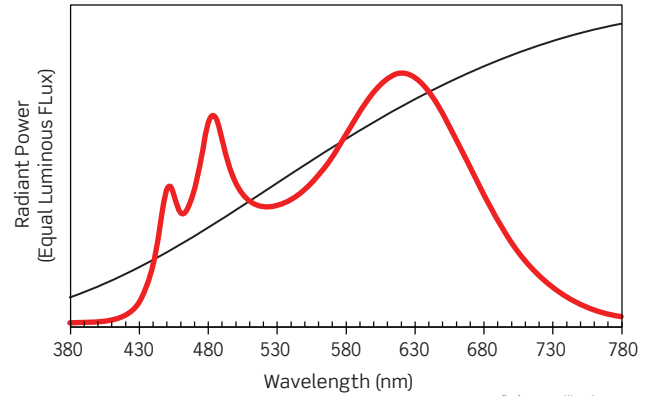

— Reference Illuminance
— Test Source

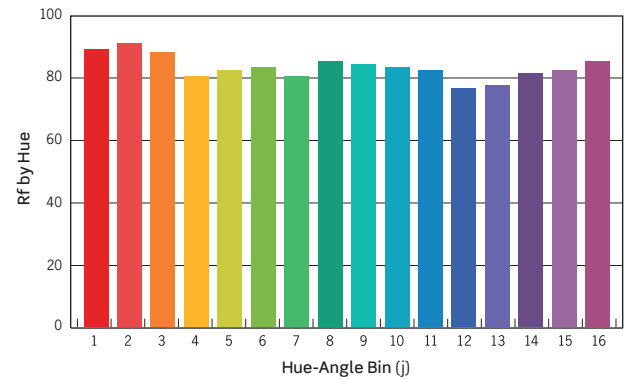
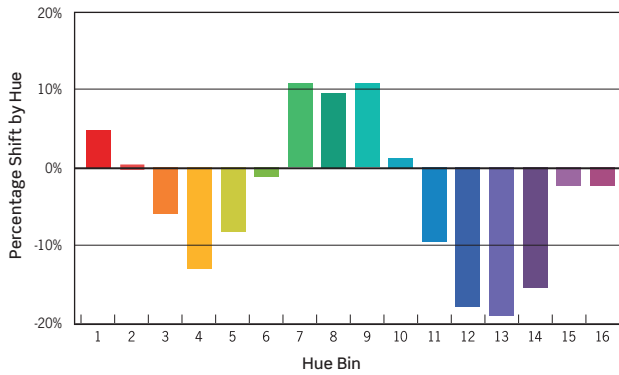

HUE BIN	1	2	3	4	5	6	7	8	9	10	11	12	13	14	15	16
HUE SHIFT	4%	0%	-5%	-10%	-7%	-1%	9%	8%	9%	1%	-8%	-15%	-16%	-13%	-2%	-2%
R _f VALUE	91	93	90	82	84	85	82	87	86	85	84	78	79	83	84	87

Colors are for visual orientation purposes only

DATE PROJECT TYPE

R6 KB SERIES | Trims for 6-Inch LED Downlights with BIOS SkyBlue™ Technology

FLANGED TRIM OPTIONS

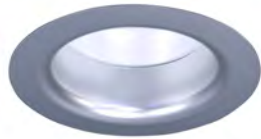

C6321-WHT-PL
White Reflector/
Platinum Lower Cone



C6321 Cone Series
*Two Piece Reflector:
Lower Cone and Flat Lens*

5-3/4-Inch ID, 7-Inch OD, 4-1/4-Inch Height

Two Piece Reflector: Upper Reflector with Lower Cone. Includes one (1) LF38-CL Clear Glass Lens. Approved for Wet Locations when Glass Lens is installed.



C6321-WHT-B
White Reflector/Black Baffle



C6321 Baffle Series
*Two Piece Reflector:
Lower Baffle and Flat Lens*

5-3/4-Inch ID, 7-Inch OD, 4-1/4-Inch Height

Two Piece Reflector: Upper Reflector with Lower Baffle. Includes one (1) LF38-CL Clear Glass Lens. Approved for Wet Locations when Glass Lens is installed.

Reflector
C6321-CLR - Clear
C6321-WHT - White

Lower Cone
CLR - Clear
PL - Platinum

Reflector
C6321-CLR - Clear
C6321-WHT - White

Lower Baffle
B - Black
P - White



C6327-CLR-PL
Clear Reflector/Platinum Lower Cone/
Regressed Prismatic Convex Lens



C6327 Cone Series
*Two Piece Reflector: Lower Cone
with Prismatic Convex Lens*

5-3/4-Inch ID, 7-Inch OD, 4-1/4-Inch Height

Two Piece Reflector with Lens: Upper Reflector with Lower Cone and Prismatic Convex Lens. Lens has 1-1/2-inch regress. Wet Location Listed.



C6327-CLR-P
Clear Reflector/White Lower Baffle/
Regressed Prismatic Convex Lens



C6327 Baffle Series
*Two Piece Reflector: Lower Baffle
with Prismatic Convex Lens*

5-3/4-Inch ID, 7-Inch OD, 4-1/4-Inch Height

Two Piece Reflector with Lens: Upper Reflector with Lower Baffle and Regressed Prismatic Convex Lens. Lens has 1-1/2-inch regress. Wet Location Listed.

Reflector
C6327-CLR - Clear
C6327-WHT - White

Lower Cone
CLR - Clear
PL - Platinum

Reflector
C6327-CLR - Clear
C6327-WHT - White

Lower Baffle
B - Black
P - White



C6322-PL
Clear Specular Reflector



C6322 Series
Specification Grade Reflector
5-3/4-Inch ID, 7-Inch OD
4-1/4-Inch Height

Specification Grade Reflector. For Wet Location approved trim, add “-C” for Clear Lens or “-SL” for Sandblast Lens after finish code.



C6323-CLR
Clear Reflector

C6323 Series
Lensed Wall Wash Reflector Trim
5-5/8-Inch ID, 7-Inch OD, 4-1/4-Inch Height

- C6322N-CLR*** - 32° Narrow Beam Clear Specular Reflector
- C6322M-CLR*** - 65° Medium Beam Clear Specular Reflector
- C6322W-CLR*** - 74° Wide Beam Clear Specular Reflector
- C6322-PL*** - 59° Platinum Reflector
- C6322-PLWHE** - 59° Platinum Wheat Reflector
- C6322-WHT** - 72° White Reflector

*Available with White Painted Flange, add “-WPF” to end of part number

- C6323-CLR*** - Clear Reflector
- C6323-PL*** - Platinum Reflector
- C6323-WHT** - White Reflector

*Available with White Painted Flange, add “-WPF” to end of part number

DATE	PROJECT	TYPE
------	---------	------

R6 KB SERIES | Trims for 6-Inch LED Downlights with BIOS SkyBlue™ Technology

TRIMLESS OPTIONS

Trimless Options require use of Mud Frame accessory (MF6, ordered separately)



CN6322 - PL
Specular Platinum Reflector



CN6322 Series
Specification Grade
Trimless Reflector

5-7/8-Inch ID, 6-1/4-Inch OD, 4-1/4-Inch H
Specification Grade Specular Reflector. For use with 1/2- to 1-inch ceiling thicknesses only. For Wet Location approved trim, add “-C” for Clear Lens or “-SL” for Sandblast Lens after finish code. **Trim cannot be used on Remodel Housings (R6RM) or with Slope Ceiling Adapters (RSA6L).**



CN6323-CLR
Clear Reflector

CN6323 Series
Trimless Lensed Wall Wash Reflector Trim
5-5/8-Inch ID; 6-1/4-Inch OD

For use with 1/2- to 1-inch ceiling thicknesses only. **Cannot be used on Remodel Housings (R6RM) or with Slope Ceiling Adapters (RSA6L).**

- CN6323-CLR** - Clear Reflector
- CN6323-PL** - Platinum Reflector
- CN6323-WHT** - White Reflector

- CN6322N-CLR** - 32° Narrow Beam Clear Specular Reflector
- CN6322M-CLR** - 65° Medium Beam Clear Specular Reflector
- CN6322W-CLR** - 74° Wide Beam Clear Specular Reflector
- CN6322-PL** - 59° Platinum Reflector
- CN6322-WHT** - 72° White Reflector

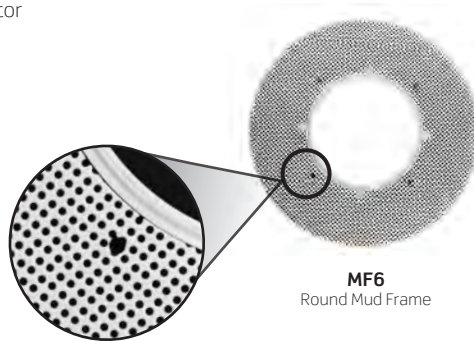

MF6
Round Mud Frame

MF6 Series
Round Mud Frame
12-Inch OD

Required for use with trimless options. Die-cast Ring with Steel Mesh Frame. Painted white.

DATE

PROJECT

TYPE



R4 and R6 LED Downlights with BIOS SkyBlue™ Circadian Lighting Technology

PRODUCT DETAILS

Dynamic 24-Hour Lighting Solutions to Regulate Circadian Systems and Create Healthier Spaces

BIOS SkyBlue™ Circadian Lighting Technology brings the benefits of blue skies inside by emulating the makeup of nature’s light spectrum.

Light sends signals to the body that create biological responses, many associated with the body’s internal 24-hour clock, or circadian system. These signals can impact mood, hormone production, energy levels, alertness, fatigue and more.

BIOS LEDs are expertly designed to generate psychological and biological responses, offering the most comprehensive approach to wellness lighting. BIOS LEDs provide high daytime stimulus by pin-pointing the peak sensitivity of the ‘sky blue’ visible light spectrum wavelengths, approx. 490nm, needed to effectively communicate and trigger circadian response.

BIOLOGICAL BENEFITS

- Strengthens Your Circadian Rhythm
- Increases Alertness
- Enhances Productivity
- Boosts Mood
- Promotes a Better Night Sleep

PERFORMANCE COMPARISONS

Spectral Power Composition and M/P Ratios: BIOS SkyBlue™ LED Compared to Traditional LEDs

The body’s biological response to light can be measured by the melanopic (non-visual) to photopic (visible light) ratio called the M/P ratio. During the day, a high M/P ratio is optimal, while at night a low M/P ratio is best.

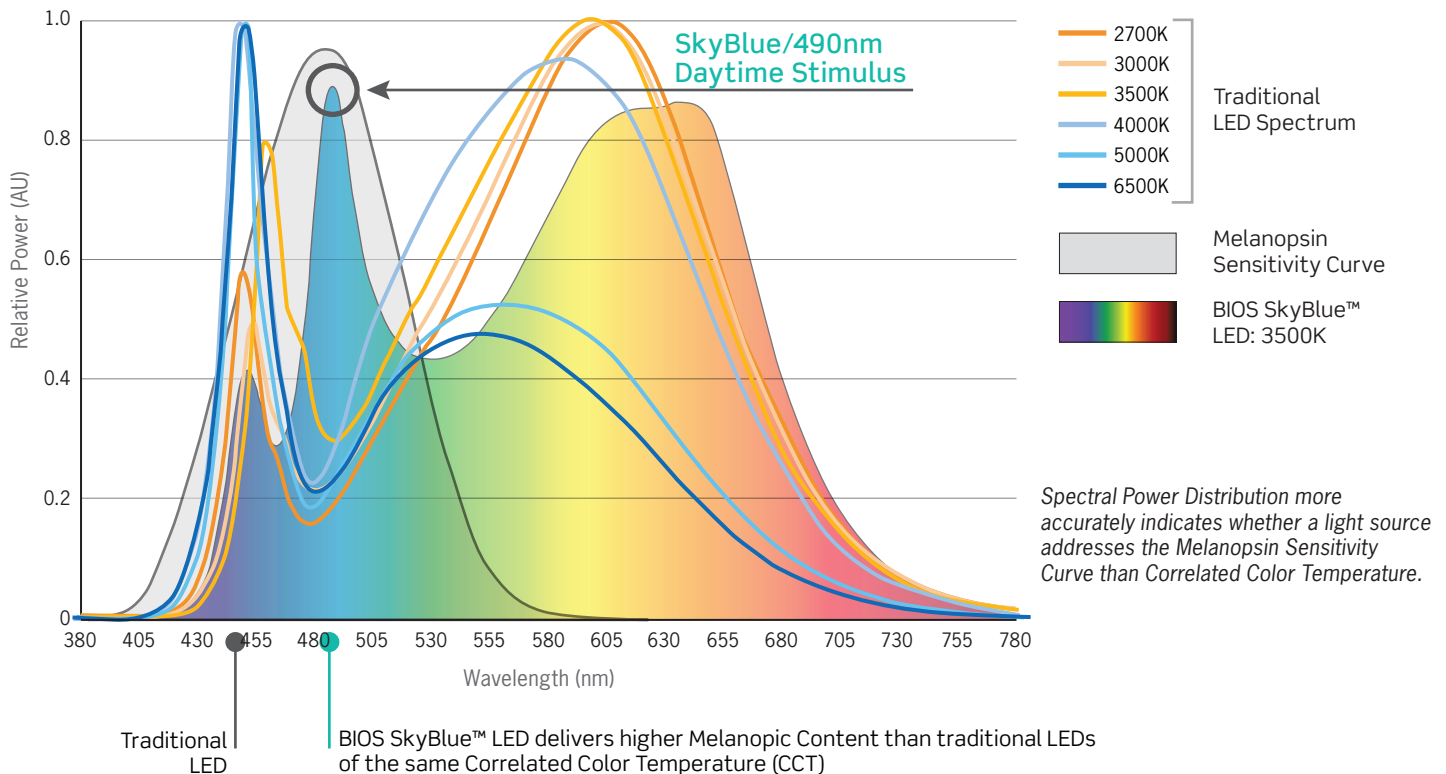

For additional information, visit www.bioslighting.com

DATE

PROJECT

TYPE



R4 and R6 LED Downlights with BIOS SkyBlue™ Circadian Lighting Technology

CIRCADIAN LIGHTING SOLUTIONS: TUNABLE AND STATIC BIO-DIMMING™ MODULES



Tunable Bio-Dimming™ Module

- Senior Living
- Hospitality
- Factories
- Residential
- Neonatal Intensive Care Unit/NICU

BIOS SkyBlue **Tunable** Bio-Dimming is best suited for 24-hour facilities or evening applications, where full light output is desired as the day progresses, but also a need to minimize circadian impact in the evening.

When dimming, the sky blue wavelengths are removed first, resulting in a modest color temperature shift to 2700K. This provides both psychological and biological benefits without a harsh change in CCT. This shift occurs within the first 20% of the dimming profile.

In the remaining 80% of the dimming profile, light output is reduced, enabling a standard linear reduction of the sky blue depleted spectrum.

Tunable Bio-Dimming adds the ability to fine-tune and dim-down the sky blue signal as desired, calibrate light levels and regulate spectral changes.

Compatible with all standard dimming and control protocols, making installation easy and inexpensive.

Static Bio-Dimming™ Module

- Schools
- Sports Facilities
- Offices
- Retail
- Healthcare Facilities
- Outpatient Clinics
- Factories

BIOS SkyBlue **Static** Bio-Dimming supports proper daytime circadian stimulus, best suited for day-only applications.

- Color of light remains constant throughout the day:
 - 490nm 'Blue Boost' does not reduce during the day
 - Apparent CCT of 3000K, 3500K or 4000K remains constant
- High Melanopic to Photopic (m/p) ratio:
 - While m/p ratio will remain constant if light level is dimmed, EML (Equivalent Melanopic Lux) and CS (Circadian Stimulus) values will be affected due to reduced vertical illuminance

A steady, but invisible, sky blue signal boost to white light is delivered throughout the day for high daytime circadian stimulus. When dimming, these sky blue wavelengths remain as overall light intensity is dimmed down.

Compatible with all standard dimming and control protocols, making installation easy and inexpensive.

BIO-DIMMING™ PROTOCOLS

TUNABLE BIO-DIMMING PROTOCOL			
DIMMER LEVEL	CCT	SKYBLUE %	LIGHT OUTPUT
100%	Initial CCT 3000K/3500K/4000K	100%	100%
99% - 81%	Gradual Shift down to 2700K	100% - 0%	100%
80%	2700K	0% No SkyBlue Wavelengths	100%
79% - 0%	2700K	0% No SkyBlue Wavelengths	Linear Dimming

STATIC BIO-DIMMING PROTOCOL			
DIMMER LEVEL	CCT	SKYBLUE %	LIGHT OUTPUT
100%	Initial CCT 3000K/3500K/4000K	100%	100%
99% - 0%	Initial CCT 3000K/3500K/4000K	100%	Linear Dimming

For additional information, visit www.bioslighting.com

DATE

PROJECT

TYPE



R4 and R6 LED Downlights with BIOS SkyBlue™ Circadian Lighting Technology

TUNABLE BIO-DIMMING™

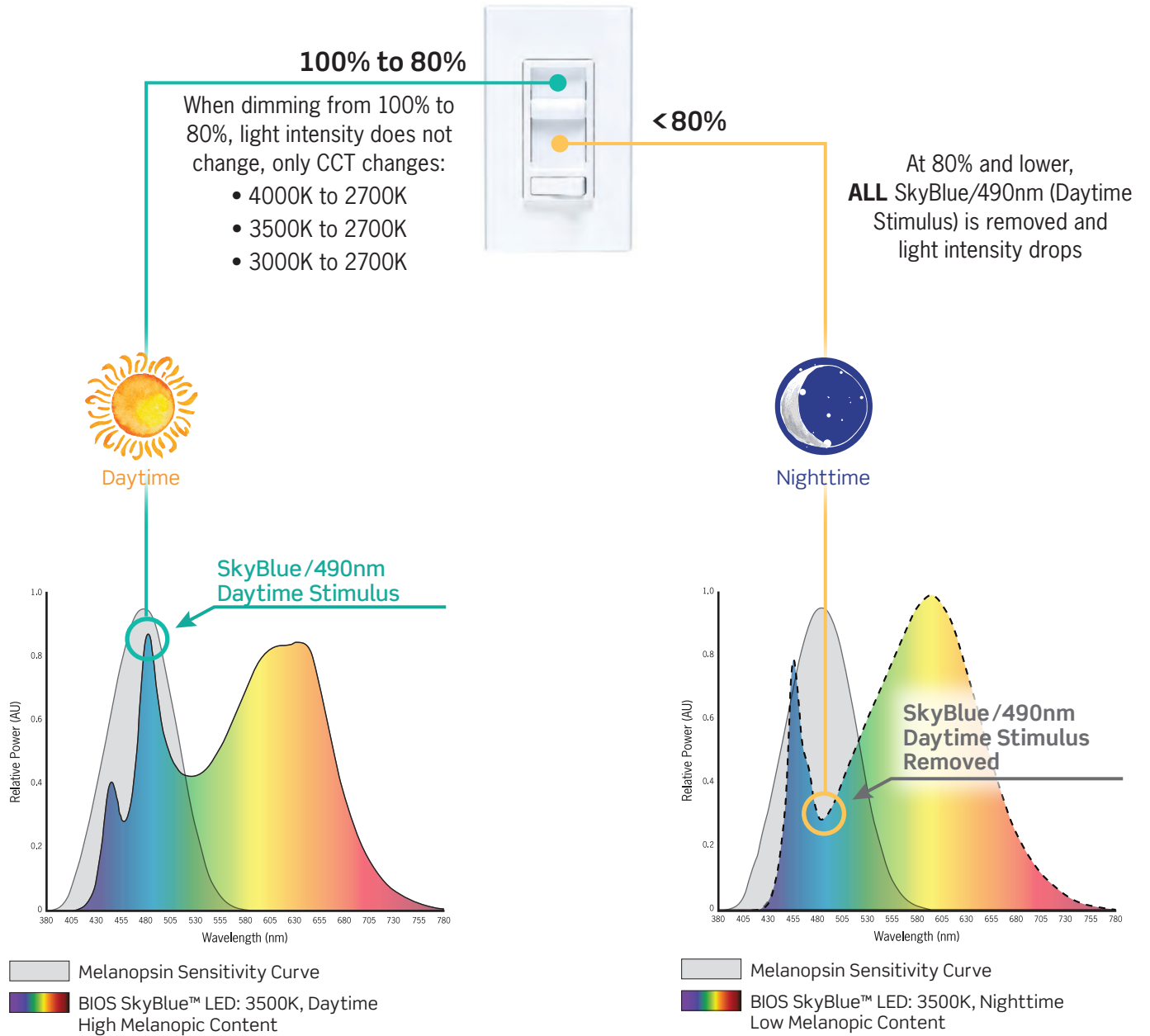

For additional information, visit www.bioslighting.com

DATE

PROJECT

TYPE



R4 and R6 LED Downlights with BIOS SkyBlue™ Circadian Lighting Technology

WELL BUILDING STANDARDS

BIOS SkyBlue™ LED contributes to satisfying Circadian Lighting Design Features and meets other features within the WELL Light Concept, including color quality and visual comfort metrics; helping buildings deliver more thoughtful and intentional spaces that enhance human health and well-being.

Circadian Lighting Design

WELL v2™ Feature L03

Provide users with appropriate exposure to light for maintaining circadian health and aligning the circadian rhythm with the day-night cycle

*EML (Equivalent Melanopic Lux) is a measurement of the effect of both natural and electric light on the human circadian rhythm.

BIOS SkyBlue™ LED

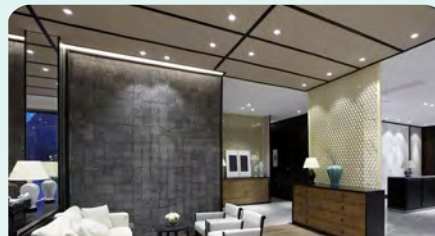

Maintains Lighting Design Intent

- Highest M/P Ratio for a given CCT
- Most effective technology to help meet EML* vertical light requirements

Traditional White LED



Increase Fixture Quantity

- More luminaires required to achieve higher light levels on vertical surfaces
- Increases energy use and lighting power density within the space

Glare Control

WELL v2™ Feature L04

Manage glare by using strategies, such as calculation of glare and choosing the appropriate light fixtures for the space

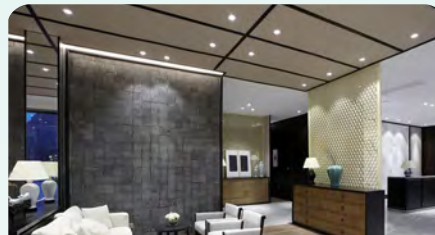

Visually Comfortable / Energy Efficient

- Higher M/P Ratio means fewer luminaires needed to illuminate the space
- Naturally minimizes amount of glare



Increase Glare / Increase Energy

- Higher output luminaires are needed within the space to meet EML targets
- Increases energy use
- Probability of increased glare and visual discomfort in the space

Electric Light Quality

WELL v2™ Feature L07

Develop and implement strategies to create a visually comfortable lighting environment

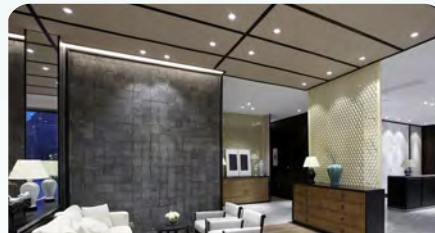

Desirable CCT / Great Color Quality

- 80+ CRI
- Ultra High R9 (>90)



Increase CCT / Decrease Color Quality

- Higher CCTs (5000K, 6500K) required to achieve the target EML values
- Does not meet R9 requirements

DATE	PROJECT	TYPE
------	---------	------

R6 KB SERIES | 6-Inch LED Downlights with BIOS SkyBlue™ Technology Dimming Specifications

- Incandescent 120VAC Dimmers adjust the light with *Forward Phase Control*, where the Dimmer “chops” the forward part of the AC Wave to deliver less or more power to the light source. No Neutral Wire Connection required.
- Electronic Low Voltage 120VAC Dimmers adjust the light with *Reverse Phase Control*, where the Dimmer “chops” the back part of the AC Wave to deliver less or more power to the light source. Neutral Wire Connection required.
- 0-10V DC Low Voltage Dimmers operate using two (2) Low Voltage Dimming Wires that are separate from the 120VAC or 277VAC power. The Dimmer sends a Variable Output Voltage to the luminaire based upon the dimming level. 10V Corresponds to undimmed operation, 5V to 50% and so on. Switching On/Off is controlled with the line voltage power (120VAC or 277VAC) input to the Dimmer. Dimming operation is controlled with the 0-10V DC Low Voltage Wiring Connection between the Dimmer and the LED Driver. The Control Signal runs on two (2) low voltage control wires color coded Violet and Pink.
- Lutron EcoSystem Drivers provide continuous dimming from 1%-100%. For a complete list of compatible Dimmers and Controls, visit www.lutron.com.
- Use DALI approved Controls for dimming eldoLED ECOdrive, 1% Dimming (Dimming Option D7 or MVD7) and eldoLED SOLOdrive, 0.1% Dimming (Dimming Option D9 or MVD9).

Manufacturer	Product	Model	TRIAC, ELV, 0-10V DIMMING (12D, 27D or MVD Option*)	eldoLED ECOdrive 0-10V (12D6, 27D6 or MVD6 Option)	eldoLED SOLOdrive 0-10V (12D8, 27D8 or MVD8 Option)
			Light Output	Light Output	Light Output
Leviton	IllumaTech	IPI06-1LZ	1%-100%	N/A	N/A
Leviton	SureSlide	6631-2	1%-100%	N/A	N/A
Leviton	Vizia	VPE06	9%-100%	N/A	N/A
Leviton	Trimatron	6683-IW	6%-100%	N/A	N/A
Leviton	Decora	6161	15%-100%	N/A	N/A
Leviton	SureSlide	6633-P	1%-100%	N/A	N/A
Leviton	IllumaTech	IPE04	6%-100%	N/A	N/A
Leviton	IllumaTech	IP710-DLX	N/A	1%-100%	0.1%-100%
Cooper	Devine	DLC03P	1%-100%	N/A	N/A
Cooper	Skye	SLC03P	0%-100%	N/A	N/A
Cooper	Decorator	DAL06P	0%-100%	N/A	N/A
Pass & Seymour	Titan	CD4FB-W	N/A	1%-100%	0.1%-100%
Synergy		ISD BC	N/A	1%-100%	0.1%-100%
Watt Stopper	Miro Decorator	DCLV1	N/A	1%-100%	0.1%-100%
Lutron	Ariadni	TGCL-153P	1%-100%	N/A	N/A
Lutron	Ariadni	TG-600P	13%-100%	N/A	N/A
Lutron	Diva	DVCL-153P	1%-100%	N/A	N/A
Lutron	Diva	DV600P	6%-100%	N/A	N/A
Lutron	Diva	DVELV303P	6%-100%	N/A	N/A
Lutron	Diva	DVTV	N/A	1%-100%	0.1%-100%
Lutron	Faetra	FAELV500	12%-100%	N/A	N/A
Lutron	Lumea	LG600P	8%-100%	N/A	N/A
Lutron	Maestro	MAELV600	16%-100%	N/A	N/A
Lutron	Nova	NFTV	N/A	1%-100%	0.1%-100%
Lutron	Nova T	NTFTV	N/A	1%-100%	0.1%-100%
Lutron	Skylark	S-603PG	5%-96%	N/A	N/A
Lutron	Skylark	S600P	5%-100%	N/A	N/A
Lutron	Skylark	SELV300P	10%-100%	N/A	N/A
Lutron	Skylark	CT103P	9%-100%	N/A	N/A

*277V Triac Dimming is not available

NOTES

1. Testing was performed with a single luminaire connected to Dimmer.
2. Testing has been performed on these Dimmers, but this does not imply any warranty of compatibility.
3. Dimming performance can be influenced by different Loads, as well as variations in Dimmer Switches within the same Model.
4. Dimmer Maximum Load Rating with LED may differ from published Traditional Source Dimmer Ratings. Consult manufacturer for maximum Dimmer information.
5. Consult factory for additional dimming information.