

DATE

PROJECT

TYPE

# SQL3 SERIES | 3-1/2-Inch Square Indoor/Outdoor Ceiling Mount Cylinders

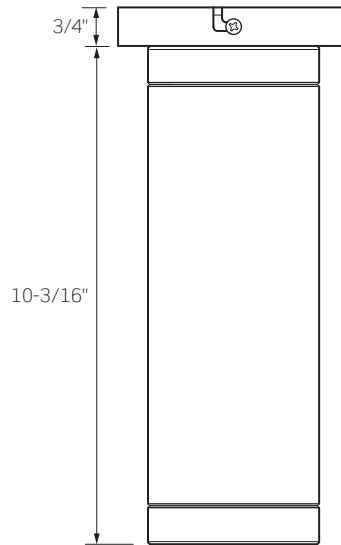
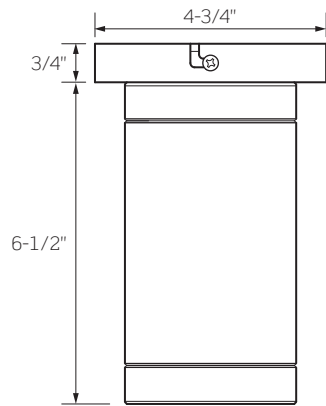

Top View: Indoor/Outdoor

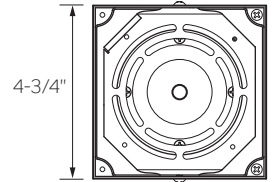



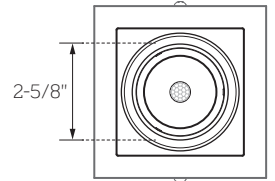

Bottom View: Indoor

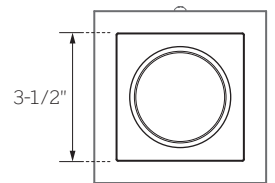

Bottom View: Outdoor



	SQL3S1/SQL3T1	SQL3S2/SQL3T2	SQL3S3/SQL3T3
WATTAGE	10W	14W	20W
LUMEN OUTPUT <sup>1</sup>	1254Lm	1728Lm	2323Lm
COLOR TEMPERATURE	2700K / 3000K / 3500K / 4000K		
CRI	83 (80min) / 90+		
BEAM	14° Spot / 28° Medium / 39° Flood / 49° Wide Flood / Wall Wash		
LUMINAIRE HEIGHT	6-1/2 Inches (Short) / 10-3/16 Inches (Tall)		
FINISHES	Matte Black / Satin Bronze / Matte White / Matte Silver / Custom Colors Available		
DRIVER INPUT WATTAGE	10W	14W	20W
DRIVER INPUT VOLTAGE	120V – 277V Dimming, 50/60Hz		
DIMMING TYPE	120V TRIAC/ELV 120V – 277V 0-10V Lutron HiLume EcoSystem		
LISTINGS	cCSAus Certified for use in the U.S. and Canada; Suitable for Damp/Dry or Wet locations Wet Location Cylinders feature a Silicone Sealed Clear Glass Lens in a Gasketed Die-Cast Trim Ring to ensure unit is watertight; IP65 Rating for Wet Location Models Cylinders must be installed per specific product installation instructions and all appropriate NEC Codes ENERGY STAR® Certified		
	   		
WARRANTY	Five (5) year replacement after date of purchase		
SYSTEM RATING	50,000 Hours @ 70% Lumen Maintenance		

1. Approximate lumen output based on 3000K performance; see photometric test results for additional information

DATE

PROJECT

TYPE

# SQL3 SERIES | 3-1/2-Inch Square Indoor/Outdoor Ceiling Mount Cylinders

## ORDERING INFORMATION

**Example Order:**  -  -

Cyl. Height	LED Series	Color Temp/CRI	Driver/Dimming	Mounting	Mntg Location	Beam
<b>SQL3S</b> - 6-1/2 in.	<b>1</b> - 10W 1254lm	83 (80min) CRI <b>27K</b> - 2700K	<b>12D1</b> - 120V TRIAC/ELV	<b>C</b> - Ceiling Mount	- Interior Dry/Damp Locations, Leave Blank <b>X</b> - Exterior/Wet Locations	<b>S</b> - 14° Spot
<b>SQL3T</b> - 11 in.	<b>2</b> - 14W 1728lm	<b>30K</b> - 3000K <b>35K</b> - 3500K <b>40K</b> - 4000K	<b>MVD2</b> - 120V-277V 0-10V Dimming			<b>M</b> - 28° Medium
	<b>3</b> - 20W 2323lm	90+ CRI <b>27KC</b> - 2700K <b>30KC</b> - 3000K <b>35KC</b> - 3500K <b>40KC</b> - 4000K	<b>MVD4</b> <sup>1</sup> - Lutron HiLume 1% EcoSystem Driver with Soft-On, Fade-to-Black			<b>F</b> - 39° Flood
						<b>WF</b> - 49° Wide Flood <b>WW</b> <sup>2</sup> - Wall Wash

- Finish**
- B** - Matte Black
  - BZ** - Satin Bronze
  - P** - Matte White
  - S** - Matte Silver
  - CC**<sup>3</sup> - Custom Color

- Battery and Remote Enclosure**<sup>4</sup>
- None, Leave Blank
  - RDB** - Remote Driver & Battery Pack
  - RD** - Remote Driver Enclosure

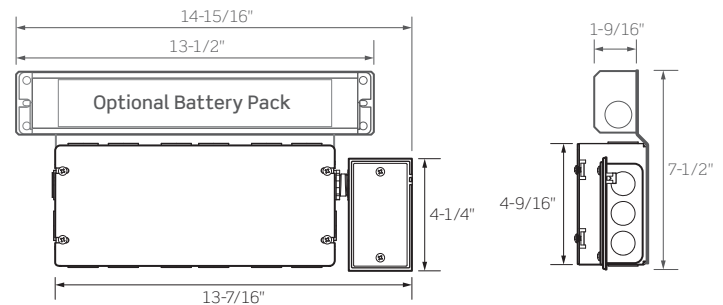

- Lutron HiLume Drivers must use Remote Driver Enclosure (RD Option)
- Wall Wash Optic (WW) is not field interchangeable with Spot, Medium, Flood and Wide Flood Optics
- Custom Color finishes available; consult factory for pricing, minimum order quantities and lead time
- RD and RDB Options must be installed in Dry/Damp Locations

**RDB:** Remote Driver & Battery Pack  
Battery Flexible Conduit Whips Not Pictured  
**RD:** Remote Driver Enclosure

## ACCESSORY ORDERING INFORMATION

### Replacement Optics

- SQL3-OPTIC-S** - 14° Spot Beam
- SQL3-OPTIC-M** - 28° Medium Beam
- SQL3-OPTIC-F** - 39° Flood Beam
- SQL3-OPTIC-WF** - 49° Wide Flood Beam

Spot (S), Medium (M), Flood (F), and Wide Flood (WF) Optics are not interchangeable with Wall Wash (WW) options

### Accessories

- FA-47** - Accessory Holder
- FA-16 60MM** - 2-3/8-Inch Diameter Black Honeycomb Louver; Requires FA-47 Accessory Holder
- LF16-\* 60MM** - 2-3/8-Inch Diameter Tempered Glass Lenses and Filters: 1/8-Inch Thick, typical; requires FA-47 Accessory Holder

### \*Color/Pattern Legend

- 73** (Spread Lens), **-LS** (Linear Spread Lens), **-SL** (Soft Light), **-SOL** (Solite),
- UV** (Optivex UV Filter), **-A** (Amber), **-B** (Blue), **-CL** (Clear), **-DPE** (Dichroic Peach),
- G** (Green), **-LB** (Light Blue), **-R** (Red), **-RO** (Rose), **-Y** (Yellow)

DATE

PROJECT

TYPE

## SQL3 SERIES | 3-1/2-Inch Square Indoor/Outdoor Ceiling Mount Cylinders

### PRODUCT DETAILS

#### Construction

- Specification Grade 3-1/2-inch square Aluminum Housing for indoor and outdoor applications
- Available in 6-1/2- and 10-3/16-inch heights with a 4-3/4-inch square Mounting Canopy
- Suitable for Dry/Damp (indoor) or Wet (outdoor) Location types
- Wet Location Cylinders feature a Polycarbonate Screw-in Lens and O-Ring to ensure unit is watertight
- Hang support for hands-free wiring

#### Performance Summary

- Available in 14° Spot, 28° Medium, 39° Flood and 49° Wide Flood Beam Distributions, as well as a Wall Wash option
- Wall Wash Optic may be rotated 360° to aim distribution pattern
- Optics have been optically engineered to provide a smooth uniform beam, maximizing output and minimizing glare
- Optics can be easily changed in the field for optimal flexibility; Wall Wash Optic (WW) is not field interchangeable with Spot, Medium, Flood or Wide Flood Optics
- 2700K, 3000K, 3500K and 4000K Color Temperatures with a CRI of 80 min., 83 typical; high CRI of 90+ available
- Excellent fixture-to-fixture color consistency within a 3-step MacAdam Ellipse tolerance
- Battery Backup option provides 90 minutes of power
- UL8750 and Class 2 compliant: RoHS compliant, U.S. only
- Output over voltage, over current and short circuit protected
- SQL3 Cylinders are available for non-dimming and dimming applications; for dimmer compatibility, refer to Dimming Specification sheet

DATE

PROJECT

TYPE

# SQL3 SERIES | 3-1/2-Inch Square Indoor/Outdoor Cylinders

## PHOTOMETRICS

### SQL3S330K12D1CS: Spot Optic

Fixture Delivered Lumens: 2246.98  
 Total Watts@120V: 19.691  
 Lumens Per Watt: 114.06  
 Center Beam Candle Power: 16355  
 Beam Distribution: 13.64°  
 Spacing Criterion: 0.2996  
 Color Rendering Index (CRI)<sup>1</sup>: 83  
 Color Temperature (CCT)<sup>2</sup>: 3059K  
 Designed for 50,000 Hour Lamp Life<sup>3</sup>  
 LM-63 Test No. G24013103  
 LM-79 Test No. S24020102

#### Intensity Distribution

DISTANCE (FT.)	FOOTCANDLES (FC)	BEAM DIAMETER (FT.)
4'	1022.2	0.96
6'	454.3	1.44
8'	255.5	1.91
10'	163.5	2.39
12'	113.6	2.87
14'	83.4	3.35

#### Candela Curve

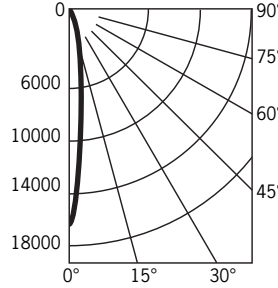

#### Spectral Power Distribution Chart<sup>4</sup>

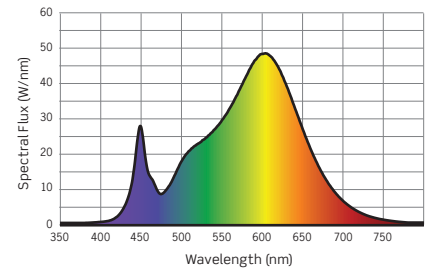

### SQL3S330K12D1CM

Fixture Delivered Lumens: 2323.28  
 Total Watts@120V: 19.742  
 Lumens Per Watt: 117.933  
 Center Beam Candle Power: 8621  
 Beam Distribution: 28.47°  
 Spacing Criterion: 0.4743  
 Color Rendering Index (CRI)<sup>1</sup>: 83  
 Color Temperature (CCT)<sup>2</sup>: 3059K  
 Designed for 50,000 Hour Lamp Life<sup>3</sup>  
 LM-63 Test No. G24013102  
 LM-79 Test No. S24020102

#### Intensity Distribution

DISTANCE (FT.)	FOOTCANDLES (FC)	BEAM DIAMETER (FT.)
4'	538.8	2.03
6'	239.5	3.04
8'	134.7	4.06
10'	86.2	5.07
12'	59.9	6.09
14'	44.0	7.10

#### Candela Curve

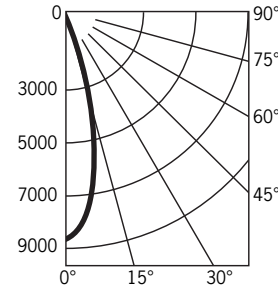

#### Spectral Power Distribution Chart<sup>4</sup>

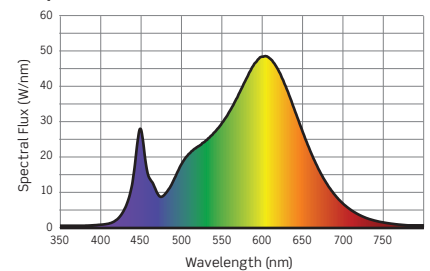

### SQL3S330K12D1CF

Fixture Delivered Lumens: 2284.87  
 Total Watts@120V: 19.691  
 Lumens Per Watt: 115.983  
 Center Beam Candle Power: 5158  
 Beam Distribution: 38.81°  
 Spacing Criterion: 0.6445  
 Color Rendering Index (CRI)<sup>1</sup>: 83  
 Color Temperature (CCT)<sup>2</sup>: 3059K  
 Designed for 50,000 Hour Lamp Life<sup>3</sup>  
 LM-63 Test No. G24013104  
 LM-79 Test No. S24020102

#### Intensity Distribution

DISTANCE (FT.)	FOOTCANDLES (FC)	BEAM DIAMETER (FT.)
4'	322.4	2.82
6'	143.3	4.23
8'	80.6	5.64
10'	51.6	7.05
12'	35.8	8.43
14'	26.3	9.86

#### Candela Curve

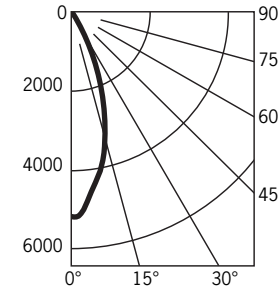

#### Spectral Power Distribution Chart<sup>4</sup>

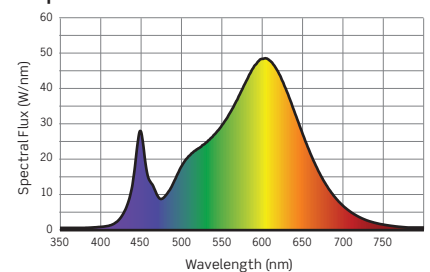

1. Accuracy of Rendering Colors 2. Color Appearance of Light Source 3. Dependent on Surrounding Temperatures 4. Colors Present within the Light Source

## PHOTOMETRIC MULTIPLICATION FACTORS

Lumen output values fluctuate based on CCT. To estimate lumen output of the various CCT/CRI options, multiply 3000K (80 CRI min) results by the following:

CCT	CCT MULTIPLIERS		OUTPUT MULTIPLIERS		
	STD CRI	HIGH CRI	10W	14W	WET LOCATION OPT.
2700K	0.949	0.842	0.54	0.744	0.972
3000K	N/A	0.872	0.54	0.744	0.972
3500K	1.02	0.895	0.54	0.744	0.972
4000K	1.04	0.916	0.54	0.744	0.972

DATE

PROJECT

TYPE

# SQL3 SERIES | 3-1/2-Inch Square Indoor/Outdoor Cylinders

## PHOTOMETRICS

### SQL3S330K12D1CWF: Wide Flood

Fixture Delivered Lumens: 1773.48  
 Total Watts@120V: 19.70  
 Lumens Per Watt: 90.0242  
 Center Beam Candle Power: 2274  
 Beam Distribution: 49.33°  
 Spacing Criterion: 0.7939  
 Color Rendering Index (CRI)<sup>1</sup>: 83  
 Color Temperature (CCT)<sup>2</sup>: 3059K  
 Designed for 50,000 Hour Lamp Life<sup>3</sup>  
 LM-63 Test No. G24013105  
 LM-79 Test No. S24020102

#### Intensity Distribution

DISTANCE (FT.)	FOOTCANDLES (FC)	BEAM DIAMETER (FT.)
4 FT	142.1	3.67
6 FT	63.2	5.51
8 FT	35.5	7.35
10 FT	22.7	9.18
12 FT	15.8	11.02
14 FT	11.6	12.86

#### Candela Curve

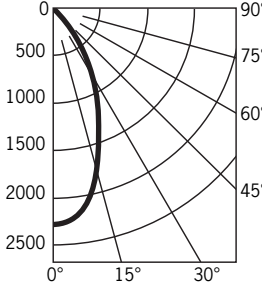

#### Spectral Power Distribution Chart<sup>4</sup>

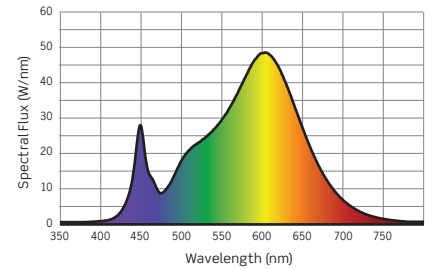

### SQL3S330K12D1CWW: Wall Wash

Fixture Delivered Lumens: 899.574  
 Total Watts@120V: 19.675  
 Lumens Per Watt: 45.6637  
 Center Beam Candle Power: 879  
 Beam Distribution: 54.5°  
 Spacing Criterion: 0.8331  
 Color Rendering Index (CRI)<sup>1</sup>: 83  
 Color Temperature (CCT)<sup>2</sup>: 3059K  
 Designed for 50,000 Hour Lamp Life<sup>3</sup>  
 LM-63 Test No. G24020101  
 LM-79 Test No. S24020102

#### Intensity Distribution

DISTANCE (FT.)	FOOTCANDLES (FC)	BEAM DIAMETER (FT.)
4 FT	55.0	4.43
6 FT	24.4	6.65
8 FT	13.7	8.86
10 FT	8.8	11.08
12 FT	6.1	13.29
14 FT	4.5	15.51

#### Candela Curve

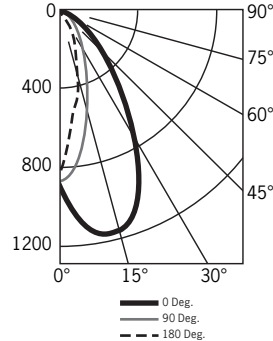

#### Spectral Power Distribution Chart<sup>4</sup>

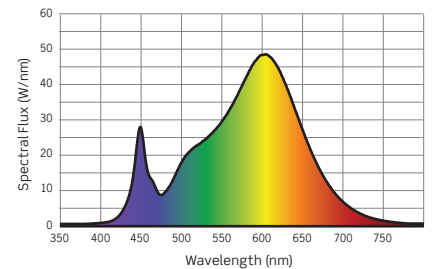

1. Accuracy of Rendering Colors 2. Color Appearance of Light Source 3. Dependent on Surrounding Temperatures 4. Colors Present within the Light Source

## PHOTOMETRIC MULTIPLICATION FACTORS

Lumen output values fluctuate based on CCT. To estimate lumen output of the various CCT/CRI options, multiply 3000K (80 CRI min) results by the following:

CCT	CCT MULTIPLIERS		OUTPUT MULTIPLIERS		
	STD CRI	HIGH CRI	10W	14W	WET LOCATION OPT.
2700K	0.935	0.703	0.59	0.78	0.94
3000K	N/A	0.754	0.59	0.78	0.94
3500K	1.0	0.812	0.59	0.78	0.94
4000K	1.0	0.870	0.59	0.78	0.94

## BUG RATINGS

Not valid for Up/Down (U/D) or Wall Mount (W) when oriented as an Uplight

	REFLECTOR				
	SPOT	MEDIUM	FLOOD	WIDE FLOOD	WALL WASH <sup>1</sup>
10W	B1 U0 G0	B1 U0 G0	B1 U0 G0	B1 U0 G0	B0 U0 G0
14W	B1 U0 G0	B1 U0 G0	B1 U0 G0	B1 U0 G0	B1 U0 G0
20W	B2 U0 G0	B2 U0 G0	B2 U0 G0	B2 U0 G0	B0 U0 G0

1. Wall Wash Rating based on Reflector used as Forward Throw

DATE

PROJECT

TYPE

# SQL3 SERIES | 3-1/2-Inch Square Indoor/Outdoor Cylinders

## PHOTOMETRICS

**TM-30 DATA: SQL3S330K12D1CM**

ANSI/IES TM-30-18 Color Rendition Report Test No. S24020102

Colors are for visual orientation purposes only

$R_f$	86
$R_g$	96
CCT(K)	3059 K
$D_{uv}$	0.0000
$u^I$	0.2486
$v^I$	0.5202

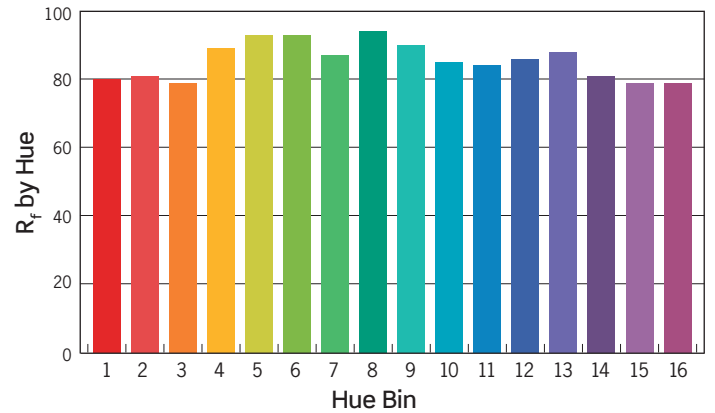
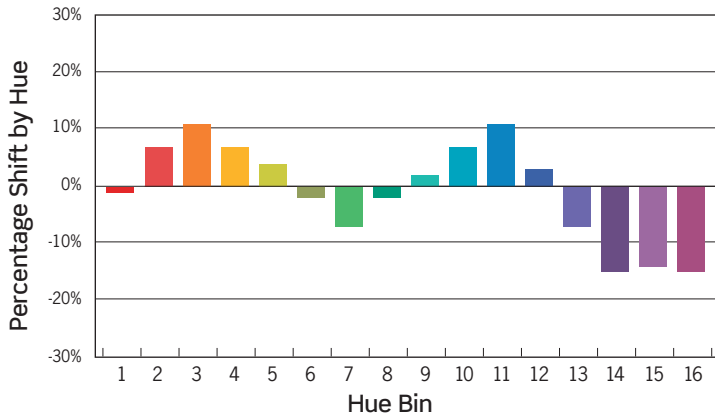
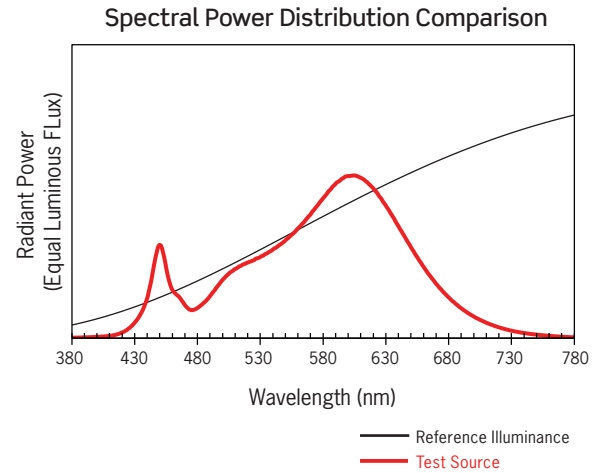
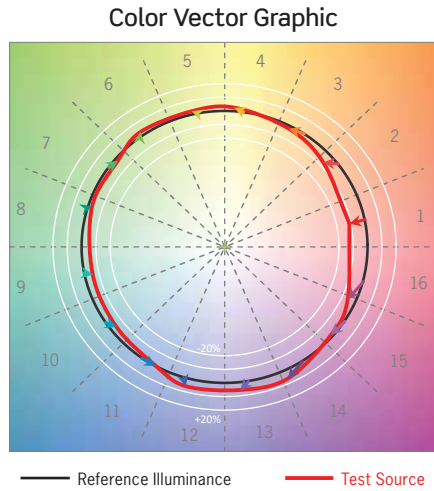

HUE BIN	1	2	3	4	5	6	7	8	9	10	11	12	13	14	15	16
HUE SHIFT	-1%	7%	11%	7%	4%	-2%	-7%	-2%	2%	7%	11%	3%	-7%	-15%	-14%	-15%
R <sub>f</sub> VALUE	80	81	79	89	93	93	87	94	90	85	84	86	88	81	79	79

Colors are for visual orientation purposes only

## SQL3 SERIES | 3-1/2 Inch Square Indoor/Outdoor Cylinders: Dimming Specifications

- Incandescent 120VAC Dimmers adjust the light with “forward phase control”, where the dimmer “chops” the forward part of the AC wave to deliver less or more power to the light source. No neutral wire connection required.
- Electronic Low Voltage 120VAC Dimmers adjust the light with “reverse phase control”, where the dimmer “chops” the back part of the AC wave to deliver less or more power to the light source. Neutral wire connection required.
- 0-10V DC Low Voltage Dimmers operate using two low voltage dimming wires that are separate from the 120V or 277V AC power. The Dimmer sends a variable output voltage to the fixture based upon the dimming level. 10V Corresponds to undimmed operation, 5V to 50% and so on. Switching on/off is controlled with the line voltage power input (120V or 277V AC) to the Dimmer and then dimming operation is controlled with the 0-10V DC low voltage wiring connection between the Dimmer and the LED Driver. The control signal runs on two low voltage control wires (color coded violet and pink/gray).
- Lutron EcoSystem Drivers provide continuous dimming from 1%-100%. For a complete list of compatible dimmers and controls, please visit [www.lutron.com](http://www.lutron.com)

			SQL3* Dimming Option 12D1 or MVD2
Manufacturer	Product	Model	Light Output
Leviton	IllumaTech	IPI06-1LZ	1%-100%
Leviton	SureSlide	6631-2	1%-100%
Leviton	Vizia	VPE06	9%-100%
Leviton	Trimatron	6683-IW	4%-100%
Leviton	Decora	6161	15%-100%
Leviton	SureSlide	6633-P	0%-100%
Leviton	IllumaTech	IPE04	6%-100%
Leviton	IllumaTech	IP710-DLX	NA
Lutron	Ariadni	TGCL-153P	4%-100%
Lutron	Ariadni	TG-600P	11%-100%
Lutron	Diva	DVCL-153P	0%-100%
Lutron	Diva	DV600P	0%-100%
Lutron	Diva	DVELV303P	6%-100%
Lutron	Diva	DVTV	NA
Lutron	Faedra	FAELV500	12%-100%
Lutron	Lumea	LG600P	5%-100%
Lutron	Maestro	MAELV600	11%-100%
Lutron	Nova	NFTV	NA
Lutron	Nova T	NTFTV	NA
Lutron	Skylark	S-603PG	4%-96%
Lutron	Skylark	S600P	1%-100%
Lutron	Skylark	SELV300P	7%-100%
Lutron	Skylark	CT103P	9%-100%
Pass & Seymour	Titan	CD4FB-W	NA
Watt Stopper	Miro Decorator	DCLV1	NA
Synergy		ISD BC	NA
Cooper	Devine	DLC03P	1%-100%
Cooper	Skye	SLC03P	0%-100%
Cooper	Decorator	DAL06P	0%-100%

\*277V Triac Dimming is not available

1. Testing was performed with a single fixture connected to dimmer.
2. Testing has been performed on these dimmers, but this does not imply any warranty of compatibility.
3. Dimming performance can be influenced by different loads, as well as variations in dimmer switches within the same model.
4. Dimmer maximum load rating with LED may differ from published traditional source dimmer ratings. Consult manufacturer for maximum dimmer information.
5. Consult factory for additional dimming information.