

WFBS SERIES | Square Baffle Slim Downlights

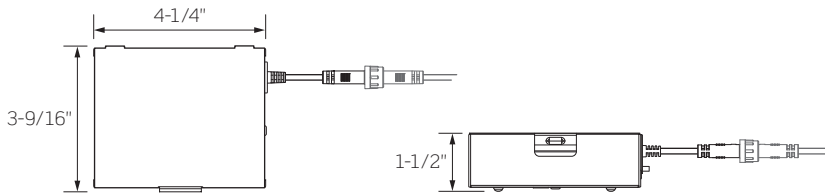
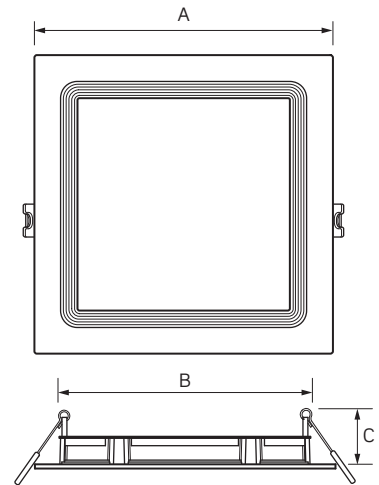

Remote Driver / Junction Box

	A	B	C	Ceiling Cut-Out
WFBS4	5-1/16"	4-1/8"	1-3/16"	4-1/4"
WFBS6	7-1/4"	6-1/8"	1-3/16"	6-1/4"

Recommended Ceiling Thickness: 1" Max.
 Total Cable Length: 14-3/8"

	WFBS4	WFBS6
SIZE	4-Inch Square	6-Inch Square
LUMEN OUTPUT ¹	850Lm	1100Lm
INPUT POWER	12W	15W
INPUT VOLTAGE, FREQUENCY	120VAC, 50/60Hz	
DIMMING TYPE	Forward or Reverse Phase Dimming from 100% to 10%	
COLOR TEMPERATURE	Selectable CCT: 2700K / 3000K / 3500K / 4000K / 5000K	
CRI	90+	
LISTINGS	cETLus Listed; Suitable for Wet Locations ENERGY STAR® Certified Can be used to comply with Title 24 Part 6 JA8 High Efficacy LED Light Source Requirements Insulated Ceiling (IC) Rated Compliant with ASTM E283 (Air Leakage Rate 2.0 CFM or Less) Suitable for use in clothes closets when installed in accordance with NEC® 410.16 (A)(1) (C)(3) spacing requirements	
WARRANTY	Five (5) year replacement after date of purchase	
SYSTEM RATING	50,000 Hours @ 70% Lumen Maintenance	

1. Lumen values are nominal and vary based on CCT

WFBS SERIES | Square Baffle Slim Downlights

ORDERING INFORMATION

Example Order: WFBS4-SW5C12D-MW

Housing	Color Temp/CRI	Driver/Dimming	Finish
WFBS4 4-Inch Square Baffle Slim WFBS6 6-Inch Square Baffle Slim	SW5C 5-CCT Selectable / 90+ CRI 2700K 3000K 3500K 4000K 5000K	12D 120V Phase Dimming (Forward/Reverse)	MW Matte White

ACCESSORY ORDERING INFORMATION



WFSPLU
New Construction Mounting Plate
 Can be used for extra support, adaptable to various luminaire sizes, as well as for mounting the Remote Driver Box

Accessory
WFSPLU New Construction Mounting Plate for 4- and 6-Inch Square WFBS Series Downlights



WFEC Series
Driver / Junction Box Extension Cables

Accessory
WFEC6 6 Foot Driver / Junction Box Extension Cable WFEC10 10 Foot Driver / Junction Box Extension Cable WFEC20 20 Foot Driver / Junction Box Extension Cable

WFBS Series
Trim Inserts
 Black, Bronze and Brushed Nickel finishes



WFBS*TI-NK

Accessory	Finish
WFBS4TI 4-In. Square Trim Insert WFBS6TI 6-In. Square Trim Insert	B Black BZ Bronze NK Brushed Nickel

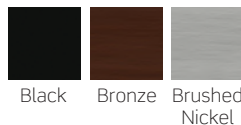

WFBS SERIES | Square Baffle Slim Downlights

PRODUCT SPECIFICATIONS

- The Square Baffle Slim Downlights are available in 4- and 6-Inch squares
- Direct mount downlighting solution that does not require an existing Housing or Junction Box
- Delivering up to 1100 lumens, the Square Baffle Slim Downlight Series is well suited for most residential and light commercial applications
- Regressed lens with baffle providing less glare and improved visual comfort
- Field selectable color temperature

PERFORMANCE SUMMARY

- Field selectable Color Temperature from 2700K, 3000K, 3500K, 4000K and 5000K; Selector Switch located on the Driver / Junction Box housing for easy selection prior to installation
- Light Engine consists of 90+ CRI LEDs with R9>50 and color accuracy within 4 SDCM
- 120V Forward or Reverse Phase Dimming from 100% to 10%, compatible with standard incandescent Dimmers (see Dimmer Compatibility List below)
- Meets Class A Sound Rating
- Edge-Lit Optical System, including Light Guide and Diffusion Lens provides a smooth, uniform wide beam distribution

CONSTRUCTION

- IC Rated Die-cast Aluminum Housing, Matte White Painted Finish
- Diffuse Polycarbonate Lens provides soft even illumination across the light emitting surface
- Remote Driver (Junction Box) is constructed of Galvanized Steel and comes with two (2) conduit Pry-outs
- Includes poke-in quick Wiring Connectors for easy installation
- Closed Cell Gasket included for use in Wet Location environments or when restrictive airflow is needed

COMPATIBLE DIMMERS

- Incandescent 120V AC Dimmers adjust the light with Forward Phase Control, where the Dimmer “chops” the forward part of the AC Wave to deliver less or more power to the light source. No Neutral Wire Connection required.
- Electronic Low Voltage 120V AC Dimmers adjust the light with Reverse Phase Control, where the Dimmer “chops” the back part of the AC Wave to deliver less or more power to the light source. Neutral Wire Connection required.

DIMMING TYPE: Forward/Reverse Phase

TYPICAL DIMMING RANGE: 100% to 10%

Supplier	Series	Model No.
Leviton	SureSlide	6674, 6674N
Leviton	IllumaTech	IPL06, IPE04
Leviton	Decora Digital	DDL06-1L, DDL06-BL, DDM06, DDMX1
Leviton	Decora Slide	DSE06, DSM10, DSL06
Leviton	Trimatron Rotary	RDL06, RNLO6
Leviton	Toggle Slide	TSL06, TSM10
Leviton	Decora Smart Wi-Fi	D26HD, DN6HD, D2MSD, DWVAA
Leviton	Decora Smart Z-wave	ZW6HD
Leviton	Decora Evolve	VM2D3, VMDD3
Lutron	Diva	DVCL-153P
Lutron	Skylark	CTCL-153P
Lutron	Ariadni Toggler	TGCL-153P
Lutron	Maestro	MACL-153M
Lutron	Caseta	P-PKG1W-WH-R
Eaton	Eaton Slide	SAL06P-W

NOTES

1. Testing has been performed on these Dimmers, but this does not imply any warranty of compatibility.
2. Dimming performance can be influenced by different Loads, as well as variations in Dimmer Switches within the same Model.
3. Dimmer Maximum Load Rating with LED may differ from published Traditional Source Dimmer Ratings; consult Dimmer Manufacturer for maximum Dimmer information.
4. Consult factory for additional dimming information.

WFBS SERIES | Square Baffle Slim Downlights

PHOTOMETRICS

WFBS4-SW5C12D-MW: 4-Inch Square Matte White Baffle

Fixture Delivered Lumens: 837.5
 Total Watts@120V: 11.4
 Lumens Per Watt: 73.5
 Center Beam Candle Power: 307
 Beam Distribution: 108°
 Spacing Criterion: 1.24
 Color Rendering Index (CRI)¹: 94
 Color Temperature (CCT)²: 3010K
 Designed for 50,000 Hour Lamp Life³
 LM-63 Test No. G23012304
 LM-79 Test No. S23012304

Intensity Distribution		
DISTANCE (FT.)	FOOTCANDLES (FC)	BEAM DIAMETER (FT.)
6 FT	8.5	16.6
8 FT	4.8	22.2
10 FT	3.1	27.7
12 FT	2.1	33.2
14 FT	1.6	38.8
16 FT	1.2	44.3

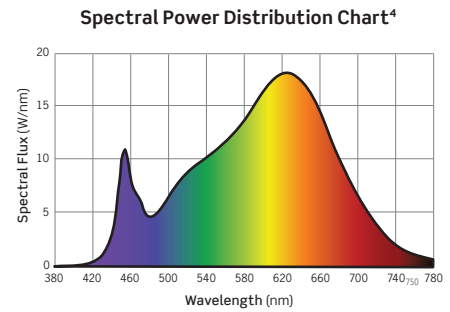
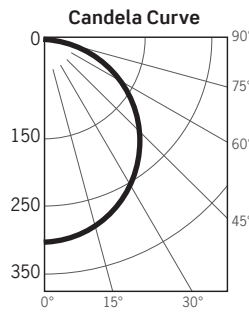

WFBS6-SW5C12D-MW: 6-Inch Square Matte White Baffle

Fixture Delivered Lumens: 1078
 Total Watts@120V: 14.2
 Lumens Per Watt: 75.9
 Center Beam Candle Power: 386
 Beam Distribution: 111°
 Spacing Criterion: 1.25
 Color Rendering Index (CRI)¹: 94.4
 Color Temperature (CCT)²: 2968K
 Designed for 50,000 Hour Lamp Life³
 LM-63 Test No. G23012309
 LM-79 Test No. S23012309

Intensity Distribution		
DISTANCE (FT.)	FOOTCANDLES (FC)	BEAM DIAMETER (FT.)
6 FT	10.7	17.3
8 FT	6.0	23.1
10 FT	3.9	28.9
12 FT	2.7	34.7
14 FT	2.0	40.4
16 FT	1.5	46.2

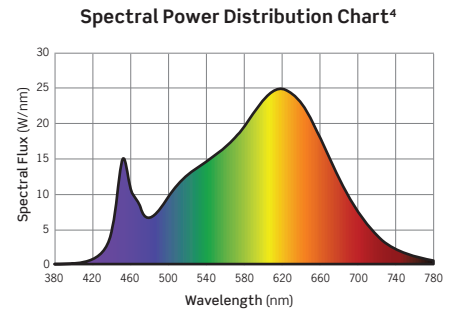
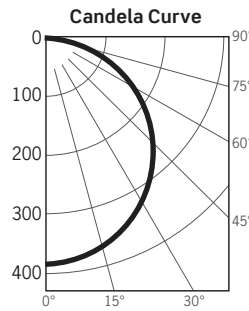

1. Accuracy of Rendering Colors 2. Color Appearance of Light Source 3. Dependent on Surrounding Temperatures 4. Colors Present within the Light Source

PHOTOMETRIC DATA

WFBS4			
NOM. CCT	LUMENS	POWER (W)	Lm/W
2700K	804	11.2	71.8
3000K	838	11.4	73.5
3500K	871	11.2	77.7
4000K	883	11.3	78.1
5000K	857	11.2	76.5

WFBS6			
NOM. CCT	LUMENS	POWER (W)	Lm/W
2700K	1042	14.0	74.4
3000K	1078	14.2	75.9
3500K	1123	14.0	80.2
4000K	1145	14.0	81.2
5000K	1121	14.0	80.1

WFBS SERIES | Square Baffle Slim Downlights

PHOTOMETRICS

TM-30 DATA: WFBS6-SW5C12D-MW 6-Inch Square Matte White Baffle

ANSI/IES TM-30-18 Color Rendition Report Test No. S23012309

R_f	93
R_g	100
CCT(K)	2968K
D_{uv}	-0.0024
u^i	0.2526
v^i	0.5186

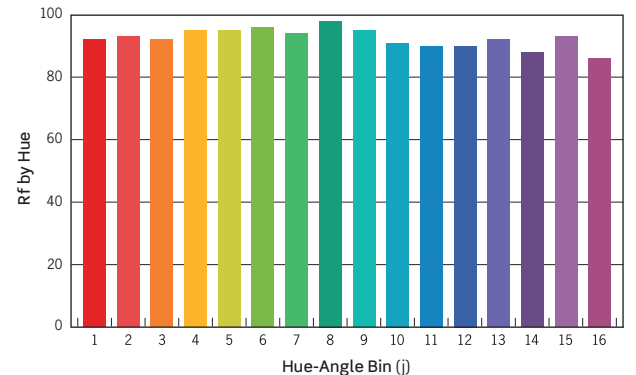
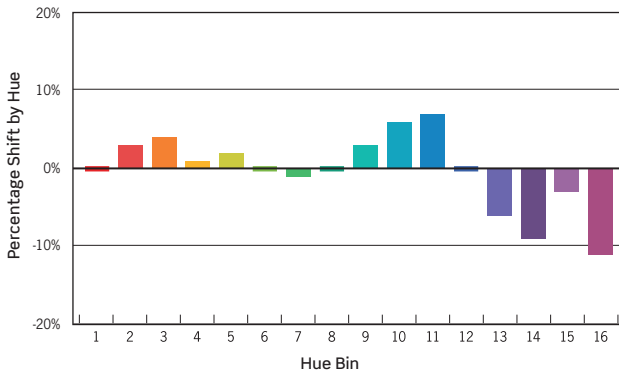
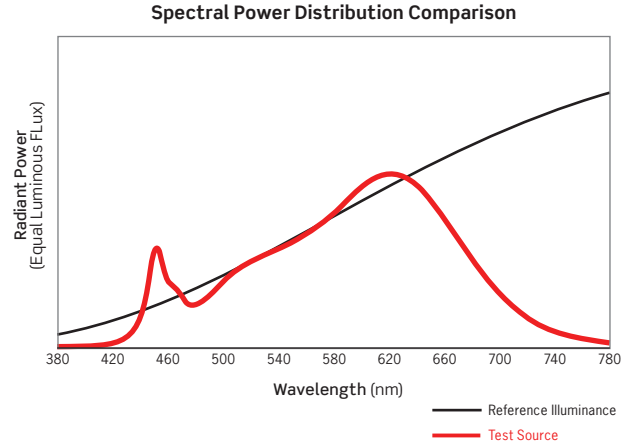
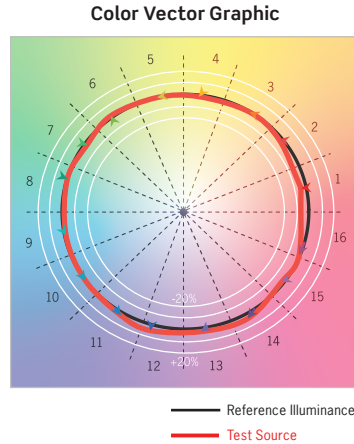

HUE BIN	1	2	3	4	5	6	7	8	9	10	11	12	13	14	15	16
HUE SHIFT	0%	3%	4%	1%	2%	0%	-1%	0%	3%	6%	7%	0%	-6%	-9%	-3%	-11%
R _f VALUE	92	93	92	95	95	96	94	98	95	91	90	90	92	88	93	86

Colors are for visual orientation purposes only