

Specflex Architectural Strip Light

AFEX2030A SERIES | 45° Angled Extra Wide Surface Mounting Channel

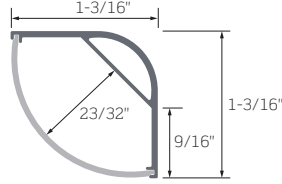

Fully assembled Channel



Channel



Lens

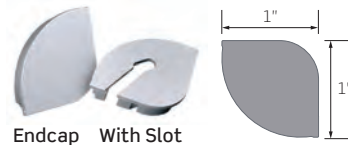
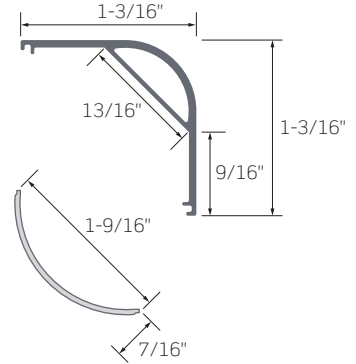

Endcap With Slot

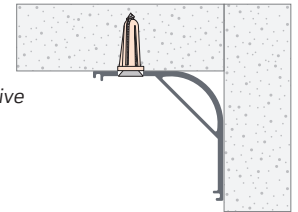
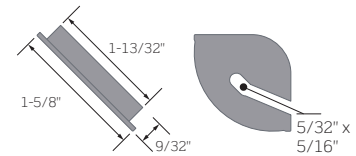

Mounts with 3M™ Double-Sided Adhesive or Screw and Wall Anchor (by others)

45° Angled Extra Wide Mounting Channel:
 ideal for cove lighting applications

- Available in 4- or 6-foot (48- or 72-inch) lengths
- Compatible with all Specflex Strip Light; Extra Wide Channel can also accommodate two (2) rows of Static White or Monochrome Color Dry Location Strip Lights for added brightness
- Field cuttable, Anodized Satin Aluminum
- Provides thermal management and heat dissipation for the Strip Light while ensuring a clean, straight run
- Frosted Diffusion Lens softens glare and reduces or removes pixelation while protecting the Strip Light from dust, debris, and moisture; ordered individually
- ABS Grey Plastic End Caps (ordered individually) create a clean finish to the Mounting Channel
- One (1) solid End Cap and one (1) slotted End Cap is recommended; use the End Cap with Slot for Power Feed
- Mounts with 3M™ Double-Sided Adhesive or Screw and Wall Anchor (by others)
- Channels and accessories are Declare Compliant

ORDERING INFORMATION

Mounting Channel	Length
AFEX2030A 45° Angled Extra Wide Mounting Channel	48 4-Ft. (48-Inches) 72 6-Ft. (72-Inches)

Finish
S Anodized Satin Aluminum

Example Order:
 AFEX2030A72-S 72-Inch Mounting Channel
 AFL20A72-FR (1) 72-Inch Frosted Diffusion Lens
 AFEX2030A-EC (1) Solid End Cap
 AFEX2030A-ECS (1) End Cap with Slot
 Mounts with 3M™ Double-Sided Adhesive or Screw and Wall Anchor (by others)

Lenses
AFL20A48-FR 4-Ft. (48-In.) Frosted Diffusion Lens
AFL20A72-FR 6-Ft. (72-In.) Frosted Diffusion Lens

Solid End Cap
AFEX2030A-EC Solid End Cap, Grey

End Cap with Slot
AFEX2030A-ECS End Cap with Slot, Grey

COMPATIBLE STRIP LIGHT

Compatible Tape Light details and ordering information can be found on Page 2. Mounting Channel is not compatible with TLT Series Tape.

IP20 DRY LOC.	PART NUMBER	DESCRIPTION
	AFSS48	Medium Density Static White
	AFSS48-7H	High Efficacy Static White
	AFSS73	High Density Static White
	AFSSCN	Continuous COB Static White
	AFSS42	Static Mono-Color
	AFSD36-4RGB	Dynamic Color RGB
	AFSD58-7RGBW	Dynamic Color RGBW

IP67 WET LOC.	PART NUMBER	DESCRIPTION
	AFSS48-7	Medium Density Static White
	AFSS48-7H-7	High Efficacy Static White
	AFSS73-7	High Density Static White
	AFSSCN-7	Continuous COB Static White
	AFSS42-7	Static Mono-Color
	AFSD36-4RGB-7	Dynamic Color RGB
	AFSD58-7RGBW-7	Dynamic Color RGBW

Specflex Architectural Strip Light

AFEX2030A SERIES | 45° Angled Extra Wide Surface Mounting Channel

STRIP LIGHT ORDERING INFORMATION

Ordering information is for Full Reels. Custom Length ordering information can be found on individual Specflex Strip Light specification sheets.

- Full Reels are available in the Max Run Length for each available Wattage for the specific Strip Light
- Each Reel has a 72-inch (6 Ft.) soldered Lead sheathed in a Plenum Rated Cable at the start of the length; additional Plenum Rated Cable available (ordered separately)
- Reels can be cut in the field to desired length at the indicated cut points

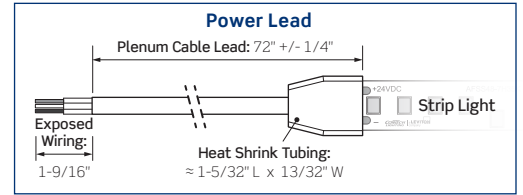

AFSS48 Medium Density Static White, 48 LEDs/Ft. IP20 Dry Location

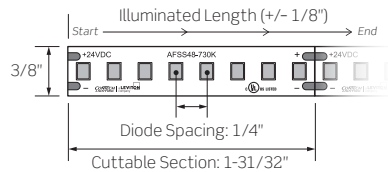

	AFSS48-2	AFSS48-3	AFSS48-5	AFSS48-7
WATTAGE	2W/Ft	3W/Ft	5W/Ft	7W/Ft
LUMEN OUTPUT	247Lm/Ft	364Lm/Ft	580Lm/Ft	777Lm/Ft
CCT/CRI	2700K/3000K/3500K/4000K 95+, R9 >84			

Example Order: AFSS48-535K-R

Wattage/Reel Length	CCT/CRI	Unit
AFSS48-2 2W/Ft 32.8 Ft Reel	95+ CRI	R Full Reel with Power Lead
AFSS48-3 3W/Ft 26.2 Ft Reel	27K 2700K	
AFSS48-5 5W/Ft 21.3 Ft Reel	30K 3000K	
AFSS48-7 7W/Ft 16.4 Ft Reel	35K 3500K 40K 4000K	

AFSS48-7H High Efficacy Static White, 48 LEDs/Ft. IP20 Dry Location

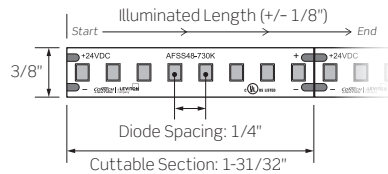

	AFSS48-7H
WATTAGE	7W/Ft
LUMEN OUTPUT	910 Lm/Ft
CCT/CRI	2700K/3000K/3500K/4000K 95+, R9 >84

Example Order: AFSS48-7H35K-R

Wattage/Reel Length	CCT/CRI	Unit
AFSS48-7H 7W/Ft 16.4 Ft Reel	90+ CRI	R Full Reel with Power Lead
	27K 2700K	
	30K 3000K	
	35K 3500K 40K 4000K	

AFSS73 High Density Static White, 73 LEDs/Ft. IP20 Dry Location

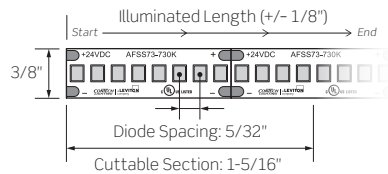

	AFSS73-3	AFSS73-5	AFSS73-7
WATTAGE	3W/Ft	5W/Ft	7W/Ft
LUMEN OUTPUT	123Lm/Ft	119Lm/Ft	117Lm/Ft
CCT/CRI	2700K/3000K/3500K/4000K 95+, R9 >84		

Example Order: AFSS73-535K-R

Wattage/Reel Length	CCT/CRI	Unit
AFSS73-3 3W/Ft 26.2 Ft Reel	95+ CRI	R Full Reel with Power Lead
AFSS73-5 5W/Ft 21.3 Ft Reel	27K 2700K	
AFSS73-7 7W/Ft 16.4 Ft Reel	30K 3000K	
	35K 3500K 40K 4000K	

Specflex Architectural Strip Light

AFEX2030A SERIES | 45° Angled Extra Wide Surface Mounting Channel

STRIP LIGHT ORDERING INFORMATION, CONTINUED

Ordering information is for Full Reels. Custom Length ordering information can be found on individual Specflex Strip Light specification sheets.

- Full Reels are available in the Max Run Length for each available Wattage for the specific Strip Light
- Each Reel has a 72-inch (6 Ft.) soldered Lead sheathed in a Plenum Rated Cable at the start of the length; additional Plenum Rated Cable available (ordered separately)
- Reels can be cut in the field to desired length at the indicated cut points

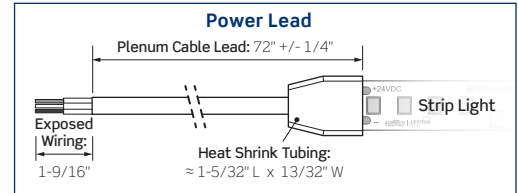

AFSSCN Continuous COB Static White IP20 Dry Location



No Pixelation

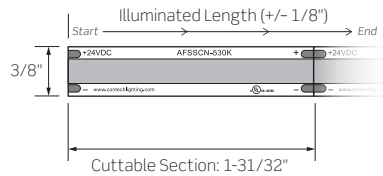

Example Order: AFSSCN-530K-R

	AFSSCN-5
WATTAGE	4.6W/Ft
LUMEN OUTPUT	432 Lm/Ft
CCT/CRI	2100K/2400K/2700K/3000K/3500K/4000K 90+

Wattage/Reel Length	CCT/CRI	Unit
AFSSCN-5 4.6W/Ft 16.4 Ft Reel	90+ CRI 21K 2100K 24K 2400K 27K 2700K 30K 3000K 35K 3500K 40K 4000K	R Full Reel with Power Lead

AFSS42 Static Mono-Color, 48 LEDs/Ft. IP20 Dry Location



Colors appear when strip is illuminated

No Pixelation

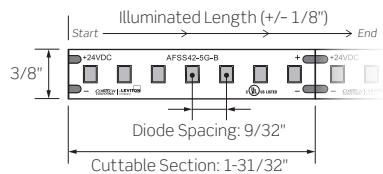

Example Order: AFSS42-5B-R

	AFSS42-5R	AFSS42-5G	AFSS42-5B	AFSS42-5A
WATTAGE	5W/Ft	5W/Ft	5W/Ft	5W/Ft
COLOR	RED	GREEN	BLUE	AMBER
LUMEN OUTPUT	193Lm/Ft	697Lm/Ft	135Lm/Ft	231Lm/Ft
WAVELENGTH	620-625nm	525-535nm	465-470nm	585-590nm

Wattage/Reel Length	Color	Unit
AFSS42-5 5W/Ft 21.3 Ft Reel	R Red G Green B Blue A Amber	R Full Reel with Power Lead

Specflex Architectural Strip Light

AFEX2030A SERIES | 45° Angled Extra Wide Surface Mounting Channel

STRIP LIGHT ORDERING INFORMATION, CONTINUED

Ordering information is for Full Reels. Custom Length ordering information can be found on individual Specflex Strip Light specification sheets.

- Full Reels are available in the Max Run Length for each available Wattage for the specific Strip Light
- Each Reel has a 72-inch (6 Ft.) soldered Lead sheathed in a Plenum Rated Cable at the start of the length; additional Plenum Rated Cable available (ordered separately)
- Reels can be cut in the field to desired length at the indicated cut points

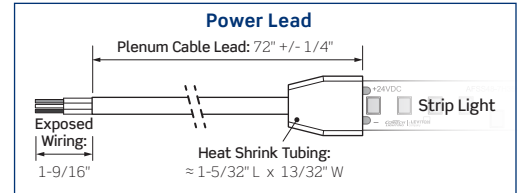

AFSD36-4RGB Dynamic Color RGB, 36 LEDs/Ft. IP20 Dry Location

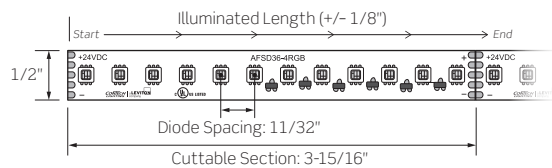
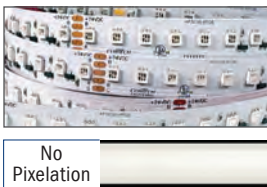

Dynamic color output using individual RGB (Red, Green, and Blue) diodes in each LED

AFSD36-4RGB			
WATTAGE	4.4W/Ft		
LUMEN OUTPUT	179 Lm/Ft		
COLOR	RED	GREEN	BLUE
WAVELENGTH	620-625nm	525-535nm	465-470nm
LUMENS/COLOR	32Lm/Ft	123Lm/Ft	30Lm/Ft

Example Order: AFSD36-4RGB

Wattage/Reel Length	Unit
AFSD36-4RGB 4.4W/Ft 22.6 Ft Reel	R Full Reel with Power Lead

AFSD58-7RGBW Dynamic Color RGBW, 58 LEDs/Ft. IP20 Dry Location

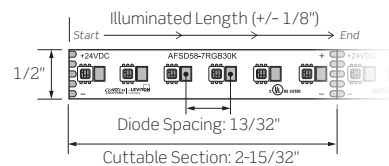

Dynamic color output using individual RGB (Red, Green, and Blue) diodes in each LED plus one (1) White LED in 2700K or 3000K at 95+ CRI

AFSD58-7RGBW				
WATTAGE	7W/Ft			
LUMEN OUTPUT	374 Lm/Ft			
COLOR	WHITE	RED	GREEN	BLUE
WAVELENGTH	N/A	620-625nm	525-535nm	465-470nm
LUMENS/COLOR	176 Lm/Ft	32 Lm/Ft	135 Lm/Ft	35 Lm/Ft

Example Order: AFSD58-7RGBW

Wattage/Reel Length	CCT/CRI	Unit
AFSD58-7RGBW 7W/Ft 16.4 Ft Reel	95+ CRI 27K 2700K 30K 3000K	R Full Reel with Power Lead

CMP Plenum Rated Cable

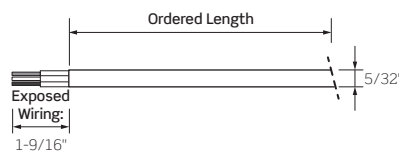

- Bare Copper conductors for excellent conductivity and low voltage drop
- Field cuttable

Example Order: CMP-2C-20

Plenum Rated Cable	Length	Unit
CMP-2C Two Conductor	10 10-Feet	30 30-Feet
CMP-4C Four Conductor	15 15-Feet	50 50-Feet
CMP-5C Five Conductor	20 20-Feet	100 100-Feet

Specflex Architectural Strip Light

AFEX2030A SERIES | 45° Angled Extra Wide Surface Mounting Channel

STRIP LIGHT ORDERING INFORMATION

Ordering information is for Full Reels. Custom Length ordering information can be found on individual Specflex Strip Light specification sheets.

- Full Reels are available in the Max Run Length for each available Wattage for the specific Strip Light
- Strip Light is encased in a silicone sleeve, factory sealed, and bonded
- Each Reel has a 72-inch (6 Ft.) soldered Lead sheathed in a Plenum Rated Cable at the start of the length; additional Plenum Rated Cable available (ordered separately)
- If field cut, use the included Silicone Endcaps with Silicone Sealant (TLAOSG, ordered separately) to re-seal the Strip Light
- Cutting the Strip will terminate the conductivity on the non-powerfeed end

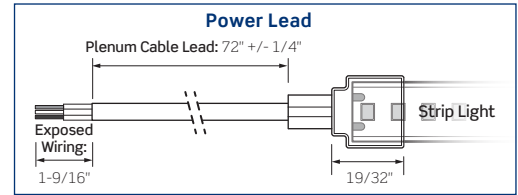

AFSS48 Medium Density Static White, 48 LEDs/Ft. IP67 Wet Location

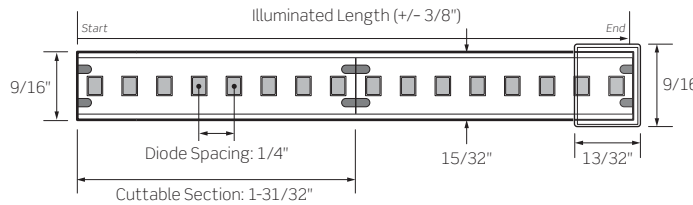
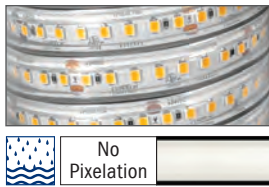

	AFSS48-2	AFSS48-3	AFSS48-5	AFSS48-7
WATTAGE	2W/Ft	3W/Ft	5W/Ft	7W/Ft
LUMEN OUTPUT	212Lm/Ft	333Lm/Ft	544Lm/Ft	787Lm/Ft
CCT/CRI	2700K/3000K/3500K/4000K 95+, R9 >84			

Wattage/Reel Length	CCT/CRI
AFSS48-2 2W/Ft 32.8 Ft Reel	95+ CRI 27K 2700K
AFSS48-3 3W/Ft 26.2 Ft Reel	30K 3000K
AFSS48-5 5W/Ft 21.3 Ft Reel	35K 3500K 40K 4000K
AFSS48-7 7W/Ft 16.4 Ft Reel	

Example Order: AFSS48-535K-7-R

Location	Unit
7 IP67 Wet Location	R Full Reel with Power Lead

AFSS48-7H High Efficacy Static White, 48 LEDs/Ft. IP67 Wet Location

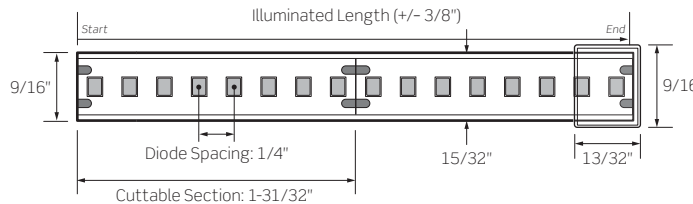
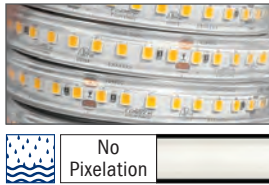

	AFSS48-7H
WATTAGE	7W/Ft
LUMEN OUTPUT	866 Lm/Ft
CCT/CRI	2700K/3000K/3500K/4000K 95+, R9 >84

Wattage/Reel Length	CCT/CRI
AFSS48-7H 7W/Ft 16.4 Ft Reel	90+ CRI 27K 2700K 30K 3000K 35K 3500K 40K 4000K

Example Order: AFSS48-7H35K-7-R

Location	Unit
7 IP67 Wet Location	R Full Reel with Power Lead

Specflex Architectural Strip Light

AFEX2030A SERIES | 45° Angled Extra Wide Surface Mounting Channel

STRIP LIGHT ORDERING INFORMATION

Ordering information is for Full Reels. Custom Length ordering information can be found on individual Specflex Strip Light specification sheets.

- Full Reels are available in the Max Run Length for each available Wattage for the specific Strip Light
- Strip Light is encased in a silicone sleeve, factory sealed, and bonded
- Each Reel has a 72-inch (6 Ft.) soldered Lead sheathed in a Plenum Rated Cable at the start of the length; additional Plenum Rated Cable available (ordered separately)
- If field cut, use the included Silicone Endcaps with Silicone Sealant (TLAOSG, ordered separately) to re-seal the Strip Light
- Cutting the Strip will terminate the conductivity on the non-powerfeed end as well as void any warranty

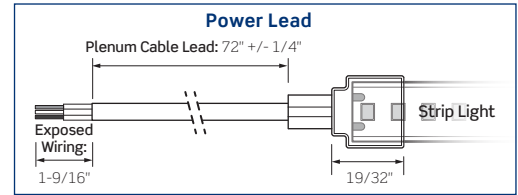

AFSS73 High Density Static White, 73 LEDs/Ft. IP67 Wet Location

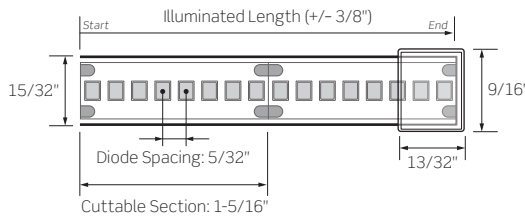
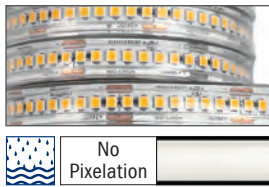

	AFSS73-3	AFSS73-5	AFSS73-7
WATTAGE	3W/Ft	5W/Ft	7W/Ft
LUMEN OUTPUT	333Lm/Ft	537Lm/Ft	695Lm/Ft
CCT/CRI	2700K/3000K/3500K/4000K 95+, R9 >84		

Wattage/Reel Length	CCT/CRI
AFSS73-3 3W/Ft 26.2 Ft Reel	95+ CRI 27K 2700K
AFSS73-5 5W/Ft 21.3 Ft Reel	30K 3000K 35K 3500K
AFSS73-7 7W/Ft 16.4 Ft Reel	40K 4000K

Example Order: AFSS73-535K-7-R

Location	Unit
7 IP67 Wet Location	R Full Reel with Power Lead

AFSSCN Continuous COB Static White IP67 Wet Location

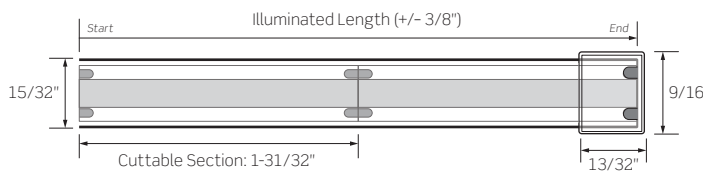
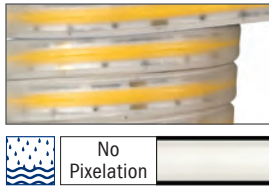

	AFSSCN-5
WATTAGE	4.6W/Ft
LUMEN OUTPUT	390 Lm/Ft
CCT/CRI	2100K/2400K/2700K/3000K/3500K/4000K 90+, R9 >84

Wattage/Reel Length	CCT/CRI
AFSSCN-5 4.6W/Ft 16.4 Ft Reel	90+ CRI 21K 2100K 24K 2400K 27K 2700K 30K 3000K 35K 3500K 40K 4000K

Example Order: AFSSCN-530K-7-R

Location	Unit
7 IP67 Wet Location	R Full Reel with Power Lead

Specflex Architectural Strip Light

AFEX2030A SERIES | 45° Angled Extra Wide Surface Mounting Channel

STRIP LIGHT ORDERING INFORMATION

Ordering information is for Full Reels. Custom Length ordering information can be found on individual Specflex Strip Light specification sheets.

- Full Reels are available in the Max Run Length for each available Wattage for the specific Strip Light
- Strip Light is encased in a silicone sleeve, factory sealed, and bonded
- Each Reel has a 72-inch (6 Ft.) soldered Lead sheathed in a Plenum Rated Cable at the start of the length; additional Plenum Rated Cable available (ordered separately)
- If field cut, use the included Silicone Endcaps with Silicone Sealant (TLAOSG, ordered separately) to re-seal the Strip Light
- Cutting the Strip will terminate the conductivity on the non-powerfeed end as well as void any warranty

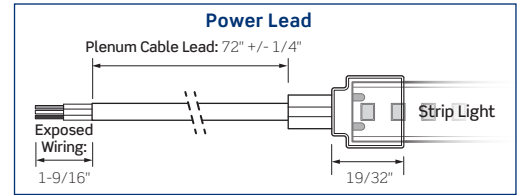

AFSS42 Static Mono-Color, 48 LEDs/Ft. IP67 Wet Location



Colors appear when strip is illuminated

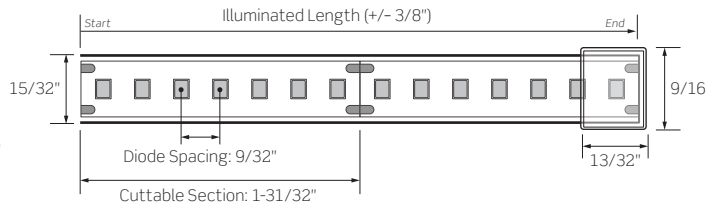

	AFSS42-5R	AFSS42-5G	AFSS42-5B	AFSS42-5A
WATTAGE	5W/Ft	5W/Ft	5W/Ft	5W/Ft
COLOR	RED	GREEN	BLUE	AMBER
LUMEN OUTPUT	153 Lm/Ft	600 Lm/Ft	119 Lm/Ft	158 Lm/Ft
WAVELENGTH	620-625nm	525-535nm	465-470nm	585-590nm

Example Order: AFSS42-5B-7-R

Wattage/Reel Length	Color	Location	Unit
AFSS42-5 5W/Ft 21.3 Ft Reel	R Red G Green B Blue A Amber	7 IP67 Wet Location	R Full Reel with Power Lead

AFSD36-RGB Dynamic Color RGB, 36 LEDs/Ft. IP67 Wet Location

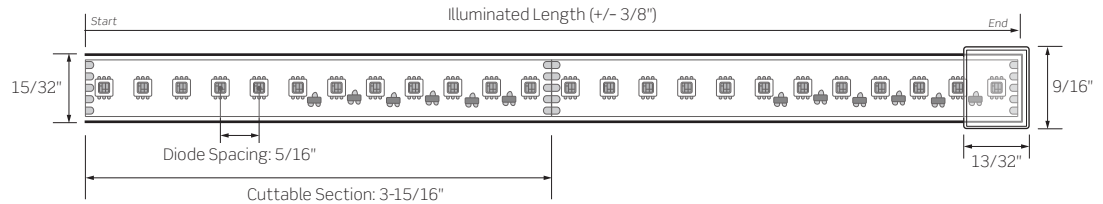

Dynamic color output using individual RGB (Red, Green, and Blue) diodes in each LED

	AFSD36-4RGB		
WATTAGE	4.4W/Ft		
LUMEN OUTPUT	144 Lm/Ft		
COLOR	RED	GREEN	BLUE
WAVELENGTH	620-625nm	525-535nm	465-470nm
LUMENS/COLOR	28 Lm/Ft	107 Lm/Ft	26 Lm/Ft

Example Order: AFSD36-RGB-7-R

Wattage/Reel Length	Location	Unit
AFSD36-4RGB 4.4W/Ft 22.6 Ft Reel	7 IP67 Wet Location	R Full Reel with Power Lead

Specflex Architectural Strip Light

AFEX2030A SERIES | 45° Angled Extra Wide Surface Mounting Channel

STRIP LIGHT ORDERING INFORMATION

Ordering information is for Full Reels. Custom Length ordering information can be found on individual Specflex Strip Light specification sheets.

- Full Reels are available in the Max Run Length for each available Wattage for the specific Strip Light
- Strip Light is encased in a silicone sleeve, factory sealed, and bonded
- Each Reel has a 72-inch (6 Ft.) soldered Lead sheathed in a Plenum Rated Cable at the start of the length; additional Plenum Rated Cable available (ordered separately)
- If field cut, use the included Silicone Endcaps with Silicone Sealant (TLAOSG, ordered separately) to re-seal the Strip Light
- Cutting the Strip will terminate the conductivity on the non-powerfeed end as well as void any warranty

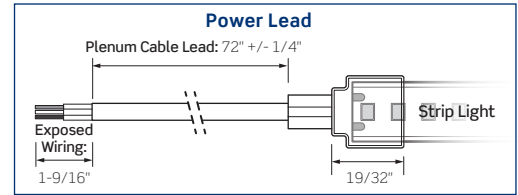

AFSD58-7RGBW-7 Dynamic Color RGBW, 58 LEDs/Ft. IP67 Wet Location

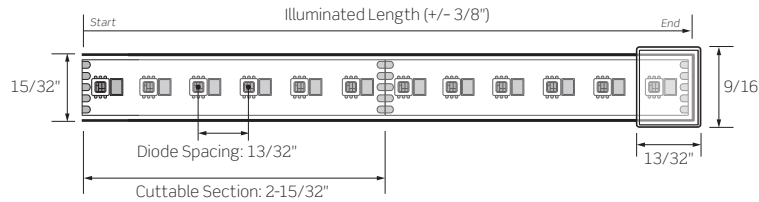

Dynamic color output using individual RGB (Red, Green, and Blue) diodes in each LED plus one (1) White LED in 2700K or 3000K at 95+ CRI

AFSD58-7RGBW				
WATTAGE	7W/Ft			
LUMEN OUTPUT	327 Lm/Ft			
COLOR	WHITE	RED	GREEN	BLUE
WAVELENGTH	N/A	620-625nm	525-535nm	465-470nm
LUMENS/COLOR	146 Lm/Ft	32 Lm/Ft	115 Lm/Ft	28 Lm/Ft

Wattage/Reel Length	CCT/CRI
AFSD58-7RGBW 7W/Ft 16.4 Ft Reel	95+ CRI 27K 2700K 30K 3000K

Example Order: AFSD58-7RGBW-7-R

Location	Unit
7 IP67 Wet Location	R Full Reel with Power Lead

TLAOSG Outdoor Sealant



- Outdoor/Wet Listed Strip Light Silicone Sealant
- For securing Endcaps to end of Wet Location Strip Light to create a water-tight seal

Silicone Sealant
TLAOSG Outdoor/Wet Listed Silicone Sealant

CMP Plenum Rated Cable

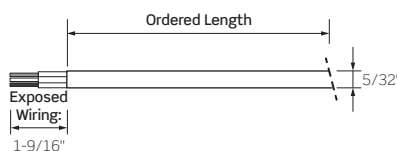

- Bare Copper conductors for excellent conductivity and low voltage drop
- Field cuttable

Plenum Rated Cable
CMP-2C Two Conductor
CMP-4C Four Conductor
CMP-5C Five Conductor

Example Order: CMP-2C-20

Length	
10 10-Feet	30 30-Feet
15 15-Feet	50 50-Feet
20 20-Feet	100 100-Feet

Specflex Architectural Strip Light

AFEX2030A SERIES | 45° Angled Extra Wide Surface Mounting Channel

POWER SUPPLY ORDERING INFORMATION

TLP24VHW Series



TLP24VHW20



TLP24VHW60



TLP24VHW96

- Hardwire Constant Voltage Driver
- 120VAC/24VDC
- Includes stripped and tinned wire pigtails on the input and output sides
- 1-Foot Wire Leads
- Class 2 Recognized
- **MUST BE MAINTAINED WITHIN AN ENCLOSURE THAT MEETS LOCAL BUILDING CODES AND NEC (SUPPLIED BY OTHERS)**

Power Supply/Wattage	
TLP24VHW20	20W 120VAC/24VDC 5-3/4" L x 1-1/2" W x 1-1/4" D
TLP24VHW60	60W 120VAC/24VDC 6-1/3" L x 1-3/4" W x 1-1/4" D
TLP24VHW96	96W 120VAC/24VDC 8-3/4" L x 2-2/3" W x 1-1/2" D

L3D0 Series



- Hi-lume Premier 0.1% EcoSystem/3-Wire Constant Voltage 24V Driver with Soft-on, Fade-to-Black
- Class 2 Enclosed 96W Constant Voltage Driver
- Universal 120 – 277VAC Input/24VDC Output
- Dimming down to 0.1% with compatible controls
- Output wattage range up to 96W maximum

Power Supply/Wattage	
L3D0-96W24V-U	96W 120-277VAC 5-1/2" W x 2" H x 10-1/2" L

TLP24VHW MVD Enclosed Series



- 120-277VAC Input/24VDC Output Class 2 Constant Voltage Enclosed Driver Hardwire Power Supply
- Phase and 0-10V Dimming deliver smooth, flicker free linear dimming down to 1% with most LEDs and a wide variety of compatible dimmers
- Dim-to-Off when used with a 0-10V Dimmer
- No minimum load requirement
- Over voltage, over current, over temperature, and short-circuit protection

Power Supply/Wattage	
TLP24VHW60MVD-ENC	60W 8" L x 3-3/8" W x 1-1/4" D
TLP24VHW100MVD-ENC	96W 8-1/4" L x 4-1/8" W x 1-1/2" D

TLP24VHW MV/MVD2 Enclosed Series



- 120 – 277VAC/24VDC Dimming and Non-dimming Hardwire Class 2 Constant Voltage Drivers
- No minimum load requirement
- Enclosure is UL Listed with built-in junction boxes
- 0-10V Dimming driver delivers smooth flicker free linear dimming down to 1% with a wide variety of compatible dimmers
- Auto-reset protection for short circuit and over temperature; over load protection in CC mode

Power Supply/Wattage	
TLP24VHW60MV-ENC	60W Non-Dimming Driver 12-1/8" L x 2-3/8" W x 1-3/8" D
TLP24VHW96MV-ENC	96W Non-Dimming Driver 12-1/8" L x 2-3/8" W x 1-3/8" D
TLP24VHW60MVD2-ENC	60W 0-10V Dimming Driver 12-1/8" L x 2-3/8" W x 1-3/8" D
TLP24VHW96MVD2-ENC	96W 0-10V Dimming Driver 12-1/8" L x 2-3/8" W x 1-3/8" D

TLP24VP Series



TLP24VP36/
TLP24VP60



TLP24VP96

- 120VAC Input/24VDC Output Plug-In Power Supply
- Includes AC Wall Plug and Female Power Output Barrel Plug for easy installation
- Barrel connectors do not fit through the ECH or ECS endcaps
- Class 2 listed

Power Supply/Wattage	
TLP24VP36	36W 4-1/4" L x 2" W x 1-3/8" H
TLP24VP60	60W 4-1/2" L x 2" W x 1-3/8" H
TLP24VP96	96W 6-1/8" L x 2-3/8" W x 1-1/2" H

Specflex Architectural Strip Light

AFEX2030A SERIES | 45° Angled Extra Wide Surface Mounting Channel

CONTROLLER ORDERING INFORMATION

UNIVERSAL CONTROLLERS & ACCESSORIES

DMX-DE3-4M

RGB/RGBW Touch Panel DMX512/eDMX Wall Mount Controller

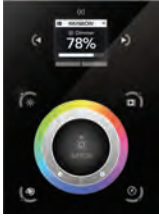

Controller

DMX-DE3-4M Touch Panel DMX512/eDMX Wall Mount Controller with Power Adapter
4-3/16" W x 5-3/4" H x 7/16" D

Finish

B Black
W White

- Mounts to a single- or double-gang electrical box, Power Adapter included
- Touch Control Interface controls color, color mixing, brightness, and speed
- Connects with TLPINT DMX Decoder to control Specflex Strip Lights
- Multi-room Control with 10 Zones, 500 Scenes, 1024 DMX Addresses (two [2] Universes), and Remote Device Management (RDM)
- Windows/Mac Software to set dynamic colors/effects; iOS/Android remote and programming apps
- Black or White Finish
- Indoor use only, not listed for Wet Locations

TLPRTW: 4-Channel Power Repeater



Repeater

TLPRTW 4-Channel Power Repeater
5-5/16" L x 1-3/4" W x 1-1/8" D

- Enables synchronized PWM signal control of multiple runs from one controller
- Use with Non-dimming Drivers
- Not UL Listed for outdoor use

TLPINT: DMX 512 CV Decoder



Decoder

TLPINT DMX 512 CV Decoder
6-3/16" L x 3-1/8" W x 1-5/8" D

- Designed to convert Universal DMX 512 Signal to PWM Signal when used with a DMX 512 Console
- Use with Non-Dimming Strip Light Power Supplies/Drivers
- Not UL listed for outdoor use

TLPRGBRF: Dimming Controller with RF Remote Control



Controller

TLPRGBRF Dimming Controller with RF Remote
8-3/8" L x 1-5/8" W x 1-3/16" D

- Pre-programmed functions including Color Strobe, 3-Channel Color Change, and Gradual Brightness Change
- Includes two (2) programmable presets
- Use with Non-dimming Drivers
- Not UL Listed for outdoor use

RGB/RGBW CONTROLLERS

TLP-UB4: Touch Panel DMX/Bluetooth Wall Mount Controller



Controller

TLP-UB4 RGB/RGBW Touch Panel DMX and Bluetooth Programmable Wall Mount Controller
5-5/16" L x 1-3/4" W x 1-1/8" D

- DMX512 Wall mounted Controller mounts to a single-gang electrical box
- Touch Control Interface to control color mixing, brightness, and more
- Connects with DMX Decoder (TLPINT Series) to control Specflex RGB and RGBW Strip Lights
- Four (4) Zones, Four (4) scenes, and 16 pre-programmed modes
- iOS and Android Compatible control app
- Indoor use only, not listed for Wet Locations

TLPRGBWRF: 28-Key Remote Controller



Controller

TLPRGBWRF 28-Key Remote Controller
6-7/8" L x 1-3/4" W x 1-3/16" D

- Eight (8) Key RF Remote for color, speed, and brightness control
- Seven (7) programmable scenes
- 20 AMP Max.

TLPRGBWTC: Dial Touch Controller



Controller

TLPRGBWTC Touch Controller
6-7/8" L x 1-3/4" W x 1-3/16" D

- Color is selected using the color wheel; plus speed and brightness control
- Pre-selected modes: eight (8) Static Color presets, four (4) Dynamic Color presets
- 20 AMP Max.