

SpecFlex
Architectural Strip Lighting

AFSS48-7H Dry Location Series

24V Static White, High Efficacy, Medium Density 48 LEDs per foot

24V Architectural Flex Strip, Static White, High Efficacy
48 LEDs per foot

This series offers a single, high output with excellent efficacy, color rendering and consistency. Designed for reliable performance and ease of use. Ideal for cove, slot, undercabinet, millwork details, architectural reveals, and endless accent lighting applications.



FEATURES

- Medium Density: 48 LEDs per foot
- High Efficacy: 130 Lm/W
- One (1) Wattage/Lumen options
- 90+ CRI and <2 SDCM ensures excellent color rendering and consistency
- Full Reels or Factory Cut into Custom Lengths
- Low power consumption with consistent, stable performance
- Wide range of Dimming and Non-dimming LED Drivers, Connectors, Mounting Channels, and Lenses
- Declare Listed
- Complete System is cCSAus Listed to UL and CSA Standards

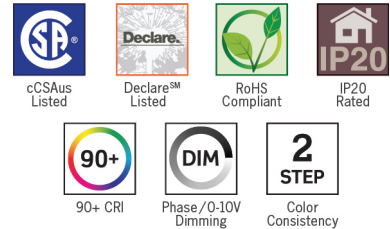

SERIES	AFSS48-7H
WATTAGE	7W/Ft
LUMEN OUTPUT ¹	910Lm/Ft
HIGH EFFICACY ¹	130Lm/W
MAX RUN LENGTH	16.4Ft
LED DENSITY	48 LEDs/Ft
CUT INCREMENT	1.97-Inches (50mm), Field Cuttable
STRIP LIGHT WIDTH	0.39-Inches (10mm)
MOUNTING	3M™ 300LSE Double Sided Tape / Channels & Clips
COLOR TEMPERATURE	2700K / 3000K / 3500K / 4000K / Consult factory for additional CCT options
CRI	90+, R9 >84
COLOR CONSISTENCY	<2 SDCM (Standard Deviation Color Matching)
OPERATING VOLTAGE	24V DC
DIMMING	Forward / Reverse Phase and 0-10V
OPERATING TEMP.	-25° to 40°C (-13° to 104°F)
LIFE RATING	50,000 Hours @ 70% Lumen Maintenance
LISTINGS	cCSAus Listed to UL and CSA Standards Suitable for Dry Locations, IP20 Rated. For Wet Location rated options, see AFSS48-7H Wet Location Series Declare Listed RoHS Compliant For use with Class 2 LED Drivers only
WARRANTY	Five (5) year replacement after date of purchase when installed within a ConTech Mounting Channel Three (3) year replacement after date of purchase when installed without a ConTech Mounting Channel

1. Approximate lumen output based on 3000K performance; see photometric test results for additional information

SpecFlex
 Architectural Strip Lighting

AFSS48-7H Dry Location Series

24V Static White, High Efficacy, Medium Density 48 LEDs per foot

ORDERING INFORMATION

FULL REELS

- Full Reels are available in Max Run Length for each available Wattage
- Each Reel has a 72-inch Plenum Rated Cable Power Lead soldered to the start of the length
- Additional Plenum Rated Cable available (ordered separately), see Page 9 for details
- Reels can be cut in the field to desired length at the indicated cut points; excess Strip Light can be configured for additional installations

Example Order: AFSS48-7H30K-R

Series	CCT ¹ /CRI	Illuminated Length
AFSS48-7H Static White: 48LEDs/Ft, 7W/Ft, High Efficacy	90+ CRI 27K 2700K 30K 3000K 35K 3500K 40K 4000K	R Full Reel with 72-inch Power lead 7W/Ft: 16.4 Ft Reel

CUSTOM LENGTHS

- Custom Lengths cannot exceed the Maximum Run Length for the specified Wattage; see Max Run Length table on Page 14 for details
- Allow additional lead time for Custom Lengths
- Custom Lengths are made-to-order and are not returnable; approved Submittal Sheets are required before processing the order

Example Order: AFSS48-7H30K-S-NT-C188

Series	CCT ¹ /CRI	Start Termination	End Termination	Custom Length
AFSS48-7H Static White: 48LEDs/Ft, 7W/Ft, High Efficacy	90+ CRI 27K 2700K 30K 3000K 35K 3500K 40K 4000K	F Female Barrel Connector M Male Barrel Connector S² 72-inch Soldered Lead Wires SXXX² Custom Length Soldered Lead Wires	NT No Termination F Female Barrel Connector M Male Barrel Connector S² 72-inch Soldered Lead Wires SXXX² Custom Length Soldered Lead Wires	CXXX Custom Length Desired length is specified in inches i.e. if the desired length is 15 Ft.-8-inches or 188-inches total, enter C188 AFSS48-7H Series has a cut increment of 1.97-inches, illuminated length will be rounded down to nearest cut increment

1. Consult factory for additional CCT options; additional lead time for special request CCTs
2. All Lead Wires come sheathed in a Plenum Rated Cable rated to 90°C minimum; specify Custom Length Lead Wires in inches; max length: 120-inches

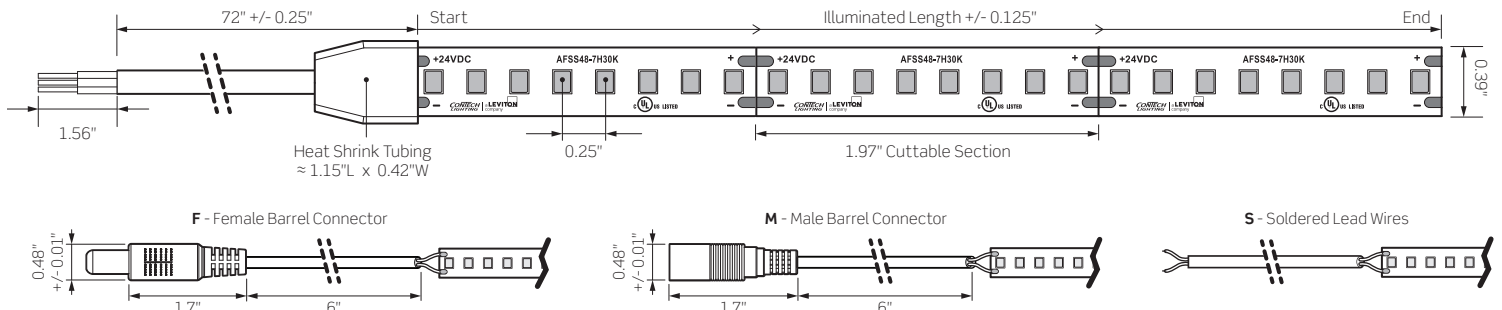

SpecFlex
 Architectural Strip Lighting

AFSS48-7H Dry Location Series

24V Static White, High Efficacy, Medium Density 48 LEDs per foot

24V MOUNTING CHANNELS AND ACCESSORIES

ALUMINUM MOUNTING CHANNEL

- Provides excellent heat sinking and protection to the LEDs while ensuring a clean, straight run
- Anodized Satin Aluminum Channel
- All Channels and Accessories are Declare Listed

CHANNEL MOUNTING CLIPS

- Stainless Steel and Adjustable Mounting Clip is ABS Plastic
- 24-Inches between clips recommended for most applications

CHANNEL ENDCAPS

- Creates a clean finish to the Mounting Channel
- ABS Grey Plastic
- Endcaps are ordered individually; one (1) solid Endcap and one (1) open Endcap (with Slot) is recommended
- Use Endcaps with Slots for Power Feed

Channel, Lens, Endcaps, and Mounting Clips are ordered separately

BEAM FOCUSING MOUNTING CHANNEL

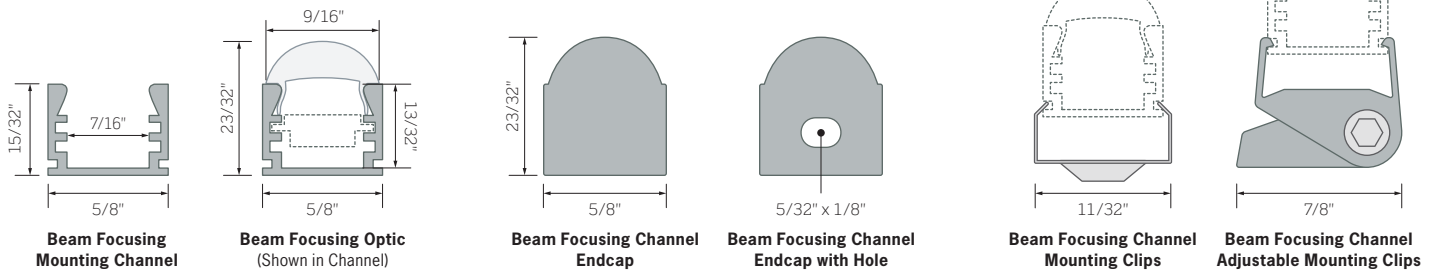

SELECT 1 OF 5 CONFIGURATIONS: (BEAM SPREADS NOT FIELD CHANGEABLE)

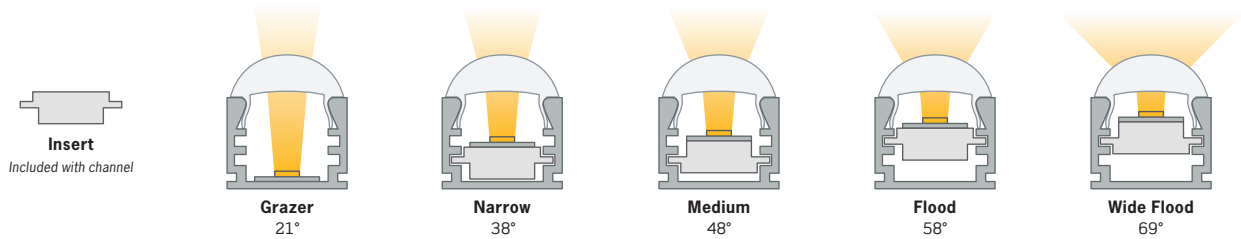

Channel and Optic
AFEX1112BEAMS78-S 78-Inch Beam Focusing Mounting Channel with Insert
AFL1112BEAMS78-FR 78-Inch Beam Focusing Optic, Frosted; Slight Pixelation with Optic

Endcaps
AFEX1112BEAMS-EC Beam Focusing Channel Solid Endcap, Grey
AFEX1112BEAMS-ECH Beam Focusing Channel Endcap with Hole, Grey

Mounting Clips
AFEX1112BEAMS-MC4 Four (4) Mounting Clips, Stainless Steel
AFEX1112BEAMS-AMC6 Six (6) Adjustable Mounting Clips, Grey

For Photometrics, see page 13
 Channel Series not compatible with Screw-Tight Connectors

SpecFlex
Architectural Strip Lighting

AFSS48-7H Dry Location Series

24V Static White, High Efficacy, Medium Density 48 LEDs per foot

24V MOUNTING CHANNELS AND ACCESSORIES

NARROW SURFACE MOUNTING CHANNEL

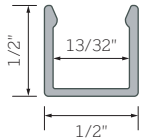

Narrow Surface Mounting Channel

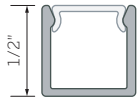

Frosted Diffusion Lens (Shown in Channel)

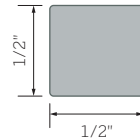

Narrow Surface Channel Endcap



Narrow Surface Channel Endcap with Slot

Channel and Lens	
AFEX1012S72-S	6 Ft. Narrow Surface Mounting Channel, Aluminum
AFL10S72-FR	6 Ft. Narrow Surface Channel Diffusion Lens, Frosted; Slight Pixelation with Diffusion Lens

Endcaps	
AFEX1012S-EC	Narrow Surface Channel Solid Endcap, Grey
AFEX1012S-ECS	Narrow Surface Channel Endcap with Slot, Grey

Mounting Clips not available; use 3M™ Double-Sided Adhesive or Screw and Wall Anchor
Channel Series not compatible with Screw-Tight Connectors

SHALLOW SURFACE MOUNTING CHANNEL

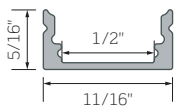

Shallow Surface Mounting Channel



Frosted Diffusion Lens (Shown in Channel)

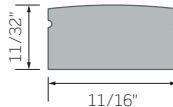

Shallow Surface Channel Endcap

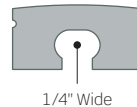

Shallow Surface Channel Endcap with Slot

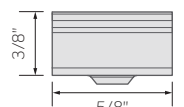
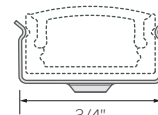

Shallow Surface Channel Mounting Clips

Channel and Lens	
AFEX1209S72-S	6 Ft. Shallow Surface Mounting Channel, Aluminum
AFL1272-FR	6 Ft. Shallow Surface Channel Diffusion Lens, Frosted; Slight Pixelation with Diffusion Lens

Endcaps	
AFEX1209S-EC	Shallow Surface Channel Solid Endcap, Grey
AFEX1209S-ECS	Shallow Surface Channel Endcap with Slot, Grey

Mounting Clips	
AFEX12S-MC4	Four (4) Mounting Clips, Stainless Steel

DEEP SURFACE MOUNTING CHANNEL

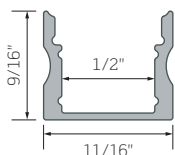

Deep Surface Mounting Channel

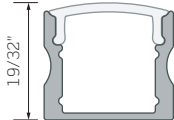

Frosted Diffusion Lens (Shown in Channel)

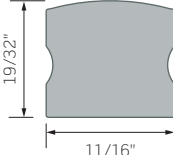

Deep Surface Channel Endcap



Deep Surface Channel Endcap with Slot

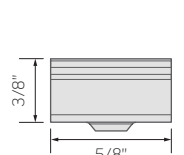
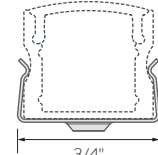

Deep Surface Channel Mounting Clips

Channel and Lens	
AFEX1215S72-S	6 Ft. Deep Surface Mounting Channel, Aluminum
AFL1272-FR	6 Ft. Deep Surface Channel Diffusion Lens, Frosted; No Pixelation with Diffusion Lens

Endcaps	
AFEX1215S-EC	Deep Surface Channel Solid Endcap, Grey
AFEX1215S-ECS	Deep Surface Channel Endcap with Slot, Grey

Mounting Clips	
AFEX12S-MC4	Four (4) Mounting Clips, Stainless Steel

SpecFlex
 Architectural Strip Lighting

AFSS48-7H Dry Location Series

24V Static White, High Efficacy, Medium Density 48 LEDs per foot

24V MOUNTING CHANNELS AND ACCESSORIES

WIDE SURFACE MOUNTING CHANNEL

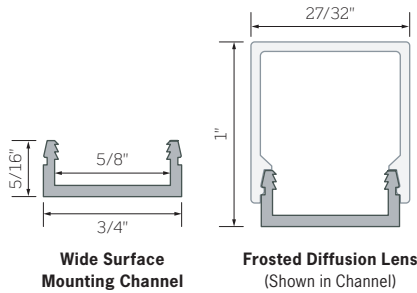

Channel and Lens	
AFEX1508S72-S	6 Ft. Wide Surface Mounting Channel, Aluminum
AFL1572-FR	6 Ft. Wide Surface Channel Diffusion Lens, Frosted; No Pixelation with Diffusion Lens

Mounting Clips not available; use 3M™ Double-Sided Adhesive or Screw and Wall Anchor

EXTRA WIDE SURFACE MOUNTING CHANNEL

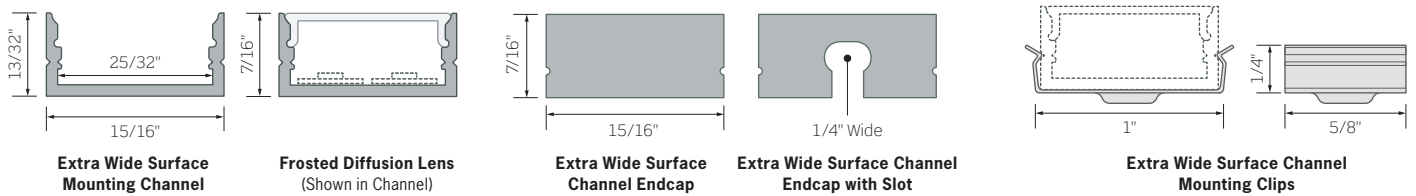

Channel and Lens	
AFEX2011S72-S	6 Ft. Extra Wide Surface Mounting Channel, Aluminum
AFL2072-FR	6 Ft. Extra Wide Surface Channel Diffusion Lens, Frosted; Slight Pixelation with Diffusion Lens

Endcaps	
AFEX2011S-EC	Extra Wide Surface Channel Solid Endcap, Grey
AFEX2011S-ECS	Extra Wide Surface Channel Endcap with Slot, Grey

Mounting Clips	
AFEX2011S-MC4	Four (4) Mounting Clips, Stainless Steel

45° ANGLED MOUNTING CHANNEL

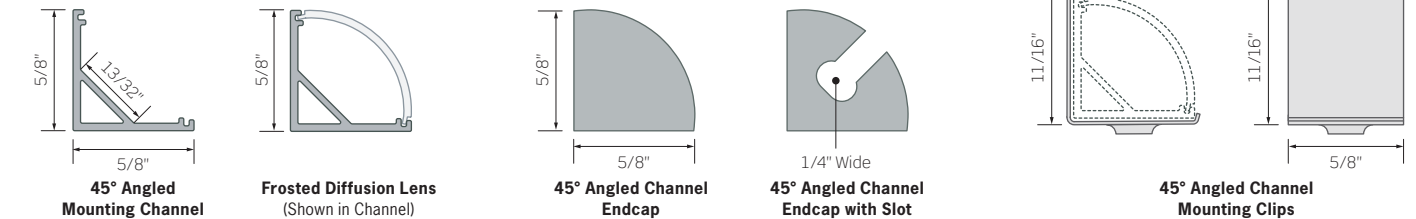

Channel and Lens	
AFEX1016A72-S	6 Ft. 45° Angled Mounting Channel, Aluminum
AFL10A72-FR	6 Ft. 45° Angled Channel Diffusion Lens, Frosted; Slight Pixelation with Diffusion Lens

Endcaps	
AFEX1016A-EC	45° Angled Channel Solid Endcap, Grey
AFEX1016A-ECS	45° Angled Channel Endcap with Slot, Grey

Mounting Clips	
AFEX1016A-MC4	Four (4) Mounting Clips, Stainless Steel

Channel Series not compatible with Screw-Tight Connectors

SpecFlex
Architectural Strip Lighting

AFSS48-7H Dry Location Series

24V Static White, High Efficacy, Medium Density 48 LEDs per foot

24V MOUNTING CHANNELS AND ACCESSORIES

45° ANGLED WIDE MOUNTING CHANNEL

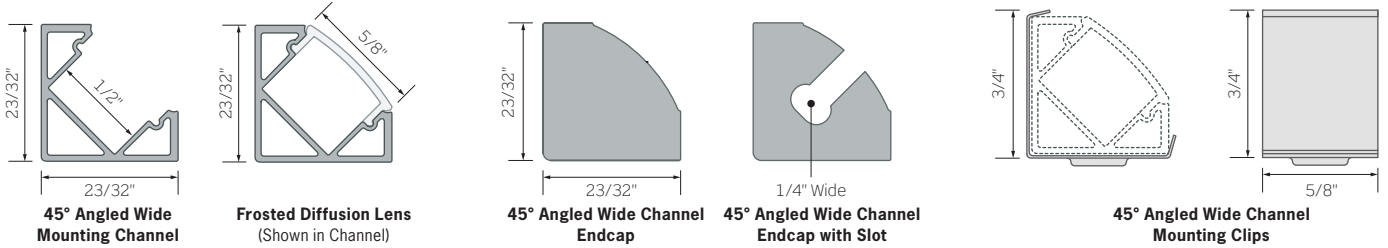

Channel and Lens	
AFEX1318A72-S	6 Ft. 45° Angled Wide Mounting Channel, Aluminum
AFL1372-FR	6 Ft. 45° Angled Wide Channel Diffusion Lens, Frosted; No Pixelation with Diffusion Lens

Endcaps	
AFEX1318A-EC	45° Angled Wide Channel Solid Endcap, Grey
AFEX1318A-ECS	45° Angled Wide Channel Endcap with Slot, Grey

Mounting Clips	
AFEX1318A-MC4	Four (4) Mounting Clips, Stainless Steel

45° ANGLED EXTRA WIDE MOUNTING CHANNEL

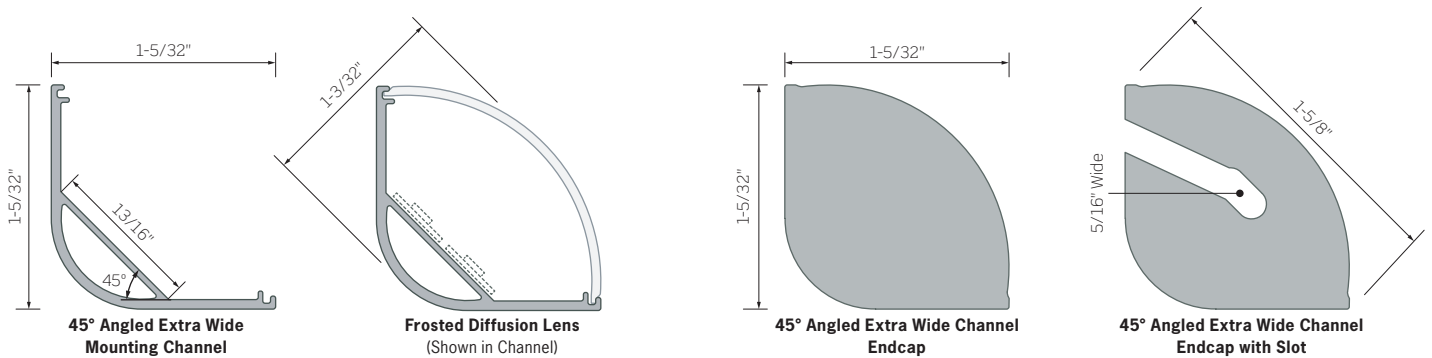

Channel and Lens	
AFEX2030A72-S	6 Ft. 45° Angled Extra Wide Mounting Channel, Aluminum
AFL20A72-FR	6 Ft. 45° Angled Extra Wide Channel Diffusion Lens, Frosted; No Pixelation with Diffusion Lens

Endcaps	
AFEX2030A-EC	45° Angled Extra Wide Channel Solid Endcap, Grey
AFEX2030A-ECS	45° Angled Extra Wide Channel Endcap with Slot, Grey

Mounting Clips not available; use 3M™ Double-Sided Adhesive or Screw and Wall Anchor

SpecFlex
Architectural Strip Lighting

AFSS48-7H Dry Location Series

24V Static White, High Efficacy, Medium Density 48 LEDs per foot

24V MOUNTING CHANNELS AND ACCESSORIES

SHALLOW RECESSED MOUNTING CHANNEL

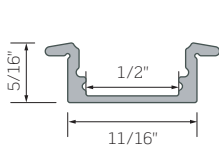

Shallow Recessed Mounting Channel

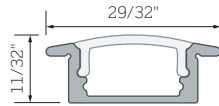

Frosted Diffusion Lens (Shown in Channel)

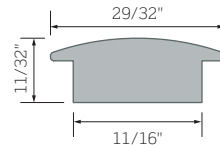

Shallow Recessed Channel Endcap



Shallow Recessed Channel Endcap with Slot

Channel and Lens	
AFEX1209R72-S	6 Ft. Shallow Recessed Mounting Channel, Aluminum
AFL1272-FR	6 Ft. Shallow Recessed Channel Diffusion Lens, Frosted; Slight Pixelation with Diffusion Lens

Endcaps	
AFEX1209R-EC	Shallow Recessed Channel Solid Endcap, Grey
AFEX1209R-ECS	Shallow Recessed Channel Endcap with Slot, Grey

Mounting Clips not available; use 3M™ Double-Sided Adhesive or Screw and Wall Anchor

DEEP RECESSED MOUNTING CHANNEL

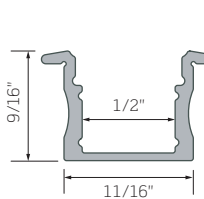

Deep Recessed Mounting Channel

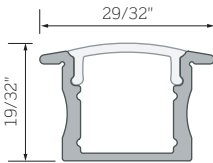

Frosted Diffusion Lens (Shown in Channel)

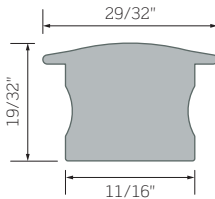

Deep Recessed Channel Endcap

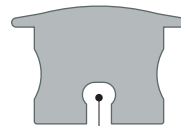

Deep Recessed Channel Endcap with Slot

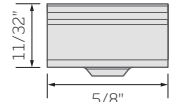
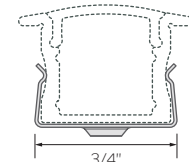

Deep Recessed Channel Mounting Clips

Channel and Lens	
AFEX1215R72-S	6 Ft. Deep Recessed Mounting Channel, Aluminum
AFL1272-FR	6 Ft. Deep Recessed Channel Diffusion Lens, Frosted; No Pixelation with Diffusion Lens

Endcaps	
AFEX1215R-EC	Deep Recessed Channel Solid Endcap, Grey
AFEX1215R-ECS	Deep Recessed Channel Endcap with Slot, Grey

Mounting Clips	
AFEX1215R-MC4	Four (4) Mounting Clips, Stainless Steel

EXTRA WIDE RECESSED MOUNTING CHANNEL

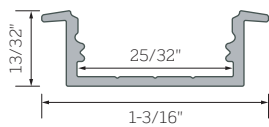

Extra Wide Recessed Mounting Channel

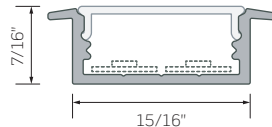

Frosted Diffusion Lens (Shown in Channel)

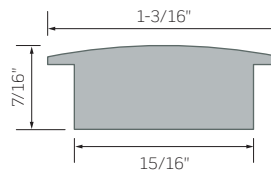

Extra Wide Recessed Channel Endcap

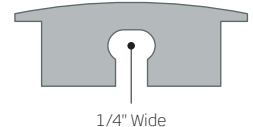

Extra Wide Recessed Channel Endcap with Slot

Channel and Lens	
AFEX2011R72-S	6 Ft. Extra Wide Recessed Mounting Channel, Aluminum
AFL2072-FR	6 Ft. Extra Wide Recessed Channel Diffusion Lens, Frosted; Slight Pixelation with Diffusion Lens

Endcaps	
AFEX2011R-EC	Extra Wide Recessed Channel Solid Endcap, Grey
AFEX2011R-ECS	Extra Wide Recessed Channel Endcap with Slot, Grey

Mounting Clips not available; use 3M™ Double-Sided Adhesive or Screw and Wall Anchor

SpecFlex
Architectural Strip Lighting

AFSS48-7H Dry Location Series

24V Static White, High Efficacy, Medium Density 48 LEDs per foot

24V CONNECTORS

TLCC Series

Barrel Connectors

- 6-Inch long Male and Female Connector
- Includes Wire Pigtail
- Hardwire to LED Driver for easy plug in connection



Model Number

- TLCCM** Male barrel connector
TLCCF Female barrel connector

TLCS Series

Plug-and-Play Power Splitter

- Approximately 2 feet long
- 2-Way: one (1) Male and two (2) Female Connectors
- 3-Way: one (1) Male and three (3) Female Connectors



Model Number

- TLCS2** Plug-and-play 2-way power splitter
TLCS3 Plug-and-play 3-way power splitter

TLCEXT Series

Plug-and-Play Power Extension

- Select from 24-, 36-, 48- and 96-inch lengths
- Male Plug Connector on one end, Female Plug Connector on other



Model Number

- TLCEXT24** 24 Inch power extension
TLCEXT36 36 Inch power extension
TLCEXT48 48 Inch power extension
TLCEXT96 96 Inch power extension

24V SCREW-TIGHT CONNECTORS

Screw-Tight Connectors not compatible with AFEX1012S, AFEX1016A, and AFEX1112BEAMS Mounting Channel Series

AFCTITEL12-W

Screw-Tight Power Lead Connector

- Includes 12-inch Plenum Rated Cable Power Lead and 3M™ VHB Adhesive Backing
- Length may be modified in field, see Installation Instructions for details
- Use to connect Power Lead to Strip Light
- 15/32"L x 15/32"W x 1/4"H
- Max Current: 10A



Model Number

- AFCTITEL12-W** Screw-tight connector with white CMP lead cable

AFCTITEJ12-W

Screw-Tight Jumper Connector

- Includes 12-inch Plenum Rated Cable Power Lead and 3M™ VHB Adhesive Backing
- Length may be modified in field, see Installation Instructions for details
- Use to connect two (2) sections of Strip Light
- 15/32"L x 15/32"W x 1/4"H
- Max Current: 10A



Model Number

- AFCTITEJ12-W** Screw-tight connector with white CMP jumper cable

AFCTITEC

Screw-Tight In-line Connector

- Use to connect two (2) sections of Strip Light in-line
- Includes 3M™ VHB Adhesive Backing
- 13/32"L x 15/32"W x 1/4"H
- Max Current: 10A



Model Number

- AFCTITEC** Screw-tight in-line connector

AFCTITEX

Screw-Tight Corner Connector

- Use to connect two (2) sections of Strip Light at a right angle
- Includes 3M™ VHB Adhesive Backing
- 9/32"L x 9/32"W x 1/4"H
- Max Current: 10A



Model Number

- AFCTITEX** Screw-tight corner connector

SpecFlex
Architectural Strip Lighting

AFSS48-7H Dry Location Series

24V Static White, High Efficacy, Medium Density 48 LEDs per foot

24V ACCESSORIES

Plenum Rated Cable

Two Conductor Plenum Rated Cable

Model Number			
CMP-2C-10	10Ft	CMP-2C-30	30Ft
CMP-2C-15	15Ft	CMP-2C-50	50Ft
CMP-2C-20	20Ft	CMP-2C-100	100Ft



24V CONTROLLERS

TLPRTW

4-Channel Power Repeater

- Enables synchronized control of multiple runs from one controller
- Use with Non-dimming LED Drivers
- Not UL Listed for outdoor use

Model Number	
TLPRTW	4-Channel Power Repeater (5-5/16" L x 1-3/4" W x 1-1/8" D)



TLPINT

DMX 512 CV Decoder

- Designed to convert universal DMX 512 signal to PWM signal when used with a DMX 512 console (by others)
- Use with Non-dimming LED Drivers
- Not UL Listed for outdoor use

Model Number	
TLPINT	DMX 512 CV Decoder (6-3/16" L x 3-1/8" W x 1-5/8" D)



TLPRGBRF

Dimming Controller with RF Remote Control

- Pre-programmed functions include: Color Strobe, 3-Channel Color Change and Gradual Brightness Change. Includes two (2) programmable presets
- Use with Non-dimming LED Drivers
- Not UL Listed for outdoor use

Model Number	
TLPRGBRF	Dimming Controller w/ RF Remote Control (8-3/8" L x 1-5/8" W x 1-3/16" D)



SpecFlex
Architectural Strip Lighting

AFSS48-7H Dry Location Series

24V Static White, High Efficacy, Medium Density 48 LEDs per foot

24V HARDWIRE LED DRIVERS

TLP24VHW Series

Hardwire Constant Voltage Driver

- 120VAC Input / 24VDC Output
- Includes stripped and tinned wire pigtails on the input and output sides
- 1 Foot Wire Leads
- Class 2 Recognized
- MUST BE MAINTAINED WITHIN AN ENCLOSURE THAT MEETS LOCAL BUILDING CODES AND NEC (SUPPLIED BY OTHERS)

Model Number	
TLP24VHW20	20W (5-3/4" L x 1-1/2" W x 1-1/4" H)
TLP24VHW60	60W (6-1/3" L x 1-3/4" W x 1-1/4" H)
TLP24VHW96	96W (6-1/8" L x 2-3/8" W x 1-1/2" H)



L3D0 Series

Hi-lume™ 0.1% EcoSystem Voltage LED Driver with Soft-On, Fade to Black™

- 120-277VAC Input / 24VDC Output
- Enclosed Class 2 Listed Constant Voltage Driver
- 96W Max

Model Number	
L3D0-96W24V-U	96W, 24V 120-277VAC (5.5" W x 2" H x 10.5" L)



TLP24VHW*MVD-ENC Series

Hardwire Class 2 Constant Voltage Enclosed Driver

- 120-277VAC Input / 24VDC Output
- Class 2 Listed Constant Voltage UL Listed Enclosed LED Driver
- Forward/Reverse Phase and 0-10V Dimming
- 0-10V Dimming delivers smooth flicker free linear dimming down to 1% with most LEDs and a wide variety of compatible dimmers
- No minimum load requirement. Over voltage, current, temperature, and short-circuit protection.

Model Number	
TLP24VHW60MVD-ENC	60W, Forward/Reverse Phase and 0-10V Dimming Driver (8" L x 3-3/8" W x 1-1/4" D)
TLP24VHW100MVD-ENC	96W, Forward/Reverse Phase and 0-10V Dimming Driver (8-1/4" L x 4-1/8" W x 1-1/2" D)



TLP24VHW*MV-ENC & TLP24VHW*MVD2-ENC Series

Hardwire Class 2 Constant Voltage Enclosed Driver

- 120-277VAC Input / 24VDC Output
- Class 2 Listed Constant Voltage UL Listed Enclosed LED Driver with built-in junction boxes; Wet Location Rated
- 0-10V Dimming and Non-dimming Models
- 0-10V Dimming Driver delivers smooth flicker free linear dimming down to 1% with most LEDs and a wide variety of compatible dimmers
- No minimum load requirement. Auto-reset protection for short circuit and over-temperature. Over load protection in CC mode.
- 12-1/8" L x 2-3/8" W x 1-3/8" D

Model Number	
TLP24VHW60MV-ENC	60W, Non-dimming Driver
TLP24VHW96MV-ENC	96W, Non-dimming Driver
TLP24VHW60MVD2-ENC	60W, 0-10V Dimming Driver
TLP24VHW96MVD2-ENC	96W, 0-10V Dimming Driver



24V PLUG-IN POWER SUPPLIES

TLP24VP Series

Plug-and-Play Power Supply

- 120VAC Input / 24VDC Output
- Includes AC Wall Plug and Female Power Output Barrel Plug for easy installation
- Class 2 Listed

Model Number	
TLP24VP36	36W (4-1/4" L x 2" W x 1-3/8" H)
TLP24VP60	60W (4-1/2" L x 2" W x 1-3/8" H)
TLP24VP96	96W (6-1/8" L x 2-3/8" W x 1-1/2" H)



SpecFlex
Architectural Strip Lighting

AFSS48-7H Dry Location Series

24V Static White, High Efficacy, Medium Density 48 LEDs per foot

PRODUCT SPECIFICATIONS

CONSTRUCTION

- Medium Density Flex Strip: 48 LEDs per foot
- High Efficacy: 130 Lm/W
- 3-Ounce Copper Construction provides excellent heat dissipation and reduced voltage drop
- Full Reels have 72-inch Soldered Lead sheathed in a Plenum Rated Cable rated to 90°C min.

LEDs

- **Color Temperature:**
2700K, 3000K, 3500K, 4000K
Consult factory for additional CCT options
- **CRI:**
90+, R9 >84
- **Color Consistency:**
<2 SDCM

ELECTRICAL

- **Input Voltage:**
24VDC
- **Average Power Consumption/Wattage:**
7W per Foot
- **Dimming:**
Forward / Reverse Phase and 0-10V Dimming
- **Ambient Operating Temp:**
-25° to 40°C (-13° to 104°F)
- System designed and rated for 50,000 hours at 70% lumen maintenance
- Drivers and Controllers ordered separately

INSTALLATION

- Includes 3M™ 300LSE Adhesive Backing for strong adhesion to channels and most smooth surfaces
- Wide selection of Aluminum Mounting Channels are available with or without a Lens, Lens sold separately
- Mounting Channels simplify installation and provide a uniform surface for strip adhesion and thermal management
- Channel Endcaps are available to create a finished appearance to the run; open or closed Endcaps are sold separately
- Mounting Clips available in packs of four (4); includes screws and dry-wall anchors for surface mounting, sold separately
- All Mounting Channels are field cuttable

OPTICS

- Create five (5) Beam Distributions (21 degrees to 69 degrees) using the Beam Focusing Optic (AFL1112BEAMS Series) and Channel with Insert (AFEX1112BEAMS Series)
- Optic and Mounting Channel (includes Insert) ordered separately
- Adjustable Mounting Clips available in packs of six (6); includes screws and dry-wall anchors for surface mounting, sold separately

CERTIFICATIONS

- cCSAus Listed to UL and CSA Standards
- IP20 Rated, suitable for Dry Locations
- Wet Location options available; see AFSS48-7H Series Wet Location Specification Sheet
- Declare Listed
- RoHS Compliant

WARRANTY

- Covered by ConTech's full replacement guarantee after date of purchase:
 - Five (5) year replacement after date of purchase when installed within Mounting Channel
 - Three (3) year replacement after date of purchase when installed without Mounting Channel



SpecFlex Architectural Striplight
ConTech Lighting

Final Assembly: Northbrook, Illinois, USA
Life Expectancy: 5 Year(s)
End of Life Options: Recyclable (35%), Landfill (65%)

Ingredients:

Aluminum; Copper; Carbonic acid, polymer with 4,4'-(1-methylethylidene)bis[phenol]; Polyvinyl chloride; Vinyl fluoride-Vinylidene fluoride-Chlorotrifluoroethylene copolymer; RTV silicone rubber; Ethylene glycol monomethyl ether; Tin, Organic; Plastiquinone; 1,3-Isobenzofurandione, polymer with 2,5-furandione and 2,2'-oxybis[ethanol]; Gold; Titanium dioxide; Silver; Diethylene Glycol

Living Building Challenge Criteria:

I-13 Red List:

<input type="checkbox"/> LBC Red List Free	% Disclosed: 100% at 100ppm
<input type="checkbox"/> LBC Red List Approved	VOC Content: Not Applicable
<input checked="" type="checkbox"/> Declared	

I-10 Interior Performance: Not Applicable
I-14 Responsible Sourcing: Not Applicable

CNT-0004
 EXP. 01 JUN 2025
 Original Issue Date: 2024

MANUFACTURER RESPONSIBLE FOR LABEL ACCURACY
 INTERNATIONAL LIVING FUTURE INSTITUTE™ living-future.org/declare

SpecFlex
Architectural Strip Lighting

AFSS48-7H Dry Location Series

24V Static White, High Efficacy, Medium Density 48 LEDs per foot

PHOTOMETRICS

AFSS48-7H30K: 24V High Efficacy Dry Location SpecFlex Strip Light

7W/Ft, 48LEDs/Ft, 1-Foot Strip, 3074K, 92 CRI

Fixture Delivered Lumens: 910.3
Total Watts@24V: 7.1
Lumens Per Watt: 128.2
Center Beam Candle Power: 313
Beam Distribution: 115°
Spacing Criterion: 1.27

LM-63 Test No. G23092103
LM-79 Test No. S23092501

Intensity Distribution

DISTANCE (FT.)	FOOTCANDLES (FC)	BEAM DIA. (FT.)
2 FT	78.2	6.3
4 FT	19.6	12.5
6 FT	8.7	18.8
8 FT	4.9	25.0
10 FT	3.1	31.3
12 FT	2.2	37.5

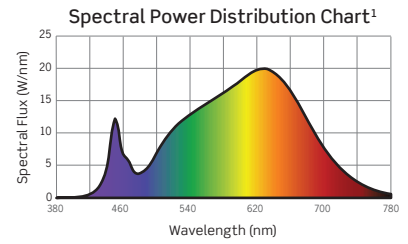
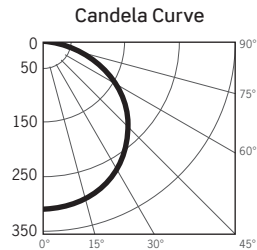

1. Colors Present within the Light Source

CCT MULTIPLIERS

2700K	3000K	3500K	4000K
0.98	N/A	1.02	1.05

AFSS48-7H30K TM-30 DATA

ANSI/IES TM-30-18 Color Rendition Report Test No. S23092501

Colors are for visual orientation purposes only

R _f	91
R _g	101
CCT (K)	3074K
D _{uv}	0.0005
u'	0.2478
v'	0.5206

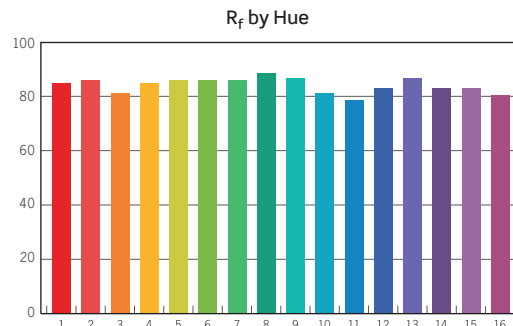
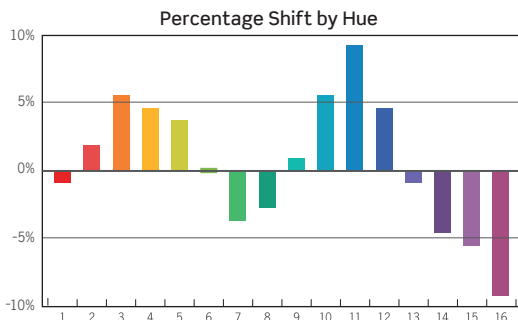
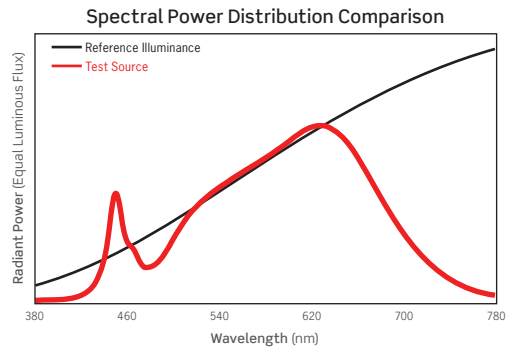
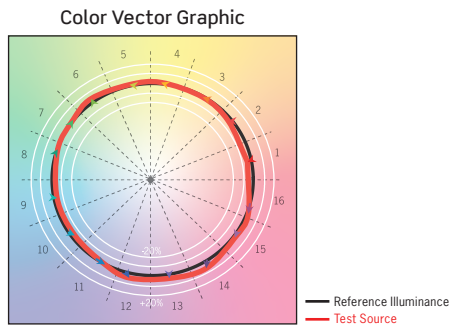

HUE BIN	1	2	3	4	5	6	7	8	9	10	11	12	13	14	15	16
HUE SHIFT	-1%	2%	6%	5%	4%	0%	-4%	-3%	1%	6%	10%	5%	-1%	-5%	-6%	-10%
R _f VALUE	92	93	88	92	93	93	93	96	94	88	85	90	94	90	90	87

SpecFlex
Architectural Strip Lighting

AFSS48-7H Dry Location Series

24V Static White, High Efficacy, Medium Density 48 LEDs per foot

PHOTOMETRICS

AFSS48-7H30K + AFEX1112BEAMS + AFL1112BEAMS: 24V Dry Location SpecFlex Strip Light

7W/Ft, 48LEDs/Ft, 1-Foot Strip, 3074K, 92 CRI

Using the Beam Focusing Mounting Channel and Frosted Diffusion Optic combined with the included Channel Insert to achieve tested Beam Spread

Grazer

LM-63 Test No. G24050105



No Insert

Fixture Delivered Lumens: 498.0
Total Watts@24V: 6.9
Lumens Per Watt: 72.2
Center Beam Candle Power: 601
Beam Distribution: 21°
Spacing Criterion: 0.36

Intensity Distribution

DISTANCE (FT.)	FOOTCANDLES (FC)	BEAM DIA. (FT.)
2 FT	150.3	0.7
4 FT	37.6	1.5
6 FT	16.7	2.2
8 FT	9.4	3.0
10 FT	6.0	3.7
12 FT	4.2	4.4

Candela Curve

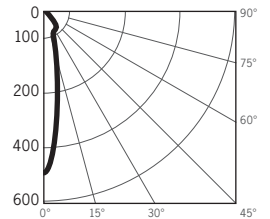

Narrow

LM-63 Test No. G24050106



Fixture Delivered Lumens: 645.0
Total Watts@24V: 6.9
Lumens Per Watt: 93.5
Center Beam Candle Power: 546
Beam Distribution: 38°
Spacing Criterion: 0.64

Intensity Distribution

DISTANCE (FT.)	FOOTCANDLES (FC)	BEAM DIA. (FT.)
2 FT	136.5	1.4
4 FT	34.1	2.8
6 FT	15.2	4.2
8 FT	8.5	5.6
10 FT	5.5	7.0
12 FT	3.8	8.3

Candela Curve

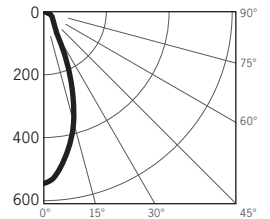

Medium

LM-63 Test No. G24050201



Fixture Delivered Lumens: 685.2
Total Watts@24V: 6.9
Lumens Per Watt: 99.3
Center Beam Candle Power: 515
Beam Distribution: 48°
Spacing Criterion: 0.74

Intensity Distribution

DISTANCE (FT.)	FOOTCANDLES (FC)	BEAM DIA. (FT.)
2 FT	128.8	1.8
4 FT	32.2	3.5
6 FT	14.3	5.3
8 FT	8.0	7.0
10 FT	5.2	8.8
12 FT	3.6	10.6

Candela Curve

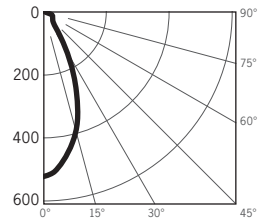

Flood

LM-63 Test No. G24050107

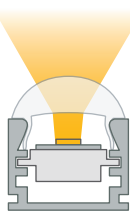

Fixture Delivered Lumens: 731.9
Total Watts@24V: 6.9
Lumens Per Watt: 106.1
Center Beam Candle Power: 464
Beam Distribution: 58°
Spacing Criterion: 0.93

Intensity Distribution

DISTANCE (FT.)	FOOTCANDLES (FC)	BEAM DIA. (FT.)
2 FT	115.9	2.2
4 FT	29.0	4.4
6 FT	12.9	6.7
8 FT	7.2	8.9
10 FT	4.6	11.1
12 FT	3.2	13.3

Candela Curve

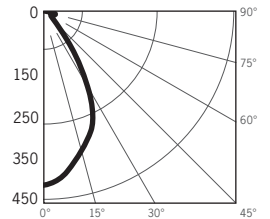

Wide Flood

LM-63 Test No. G24050202



Fixture Delivered Lumens: 756.6
Total Watts@24V: 6.9
Lumens Per Watt: 109.7
Center Beam Candle Power: 437
Beam Distribution: 69°
Spacing Criterion: 1.02

Intensity Distribution

DISTANCE (FT.)	FOOTCANDLES (FC)	BEAM DIA. (FT.)
2 FT	109.3	2.7
4 FT	27.3	5.5
6 FT	12.1	8.2
8 FT	6.8	11.0
10 FT	4.4	13.7
12 FT	3.0	16.5

Candela Curve

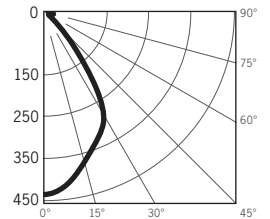

CCT MULTIPLIERS			
2700K	3000K	3500K	4000K
0.98	N/A	1.02	1.05

SpecFlex

Architectural Strip Lighting

AFSS48-7H Dry Location Series

24V Static White, High Efficacy, Medium Density 48 LEDs per foot

DIMMING SPECIFICATIONS LED Drivers have been tested with the following Dimmer Models:

TRIAC (LEADING EDGE) DIMMING

Manufacturer	Product	Model
Leviton	SureSlide	6672, 6674, 6674N, 66DF
	Decora Smart	D26HD, D2MSD, DN6HD
	Decora Digital	DDL06-1, DDM06, DDL06-1, DDMX1
	Decora Slide	DSL06, DSM10
	Illumatech	IPL06
	Trimatron Rotary	RDL06, RNL06
	Toggle Slide	TSL06, TSM10
Lutron	Caseta	PD-6WCL
	Diva	DVCL-153P
	Lumea	LECL-153P
	Maestro	MACL-153M
	Skylark	SCL-153P
	Toggler	TGCL-153P

ELV (TRAILING EDGE) DIMMING

Manufacturer	Product	Model
Leviton	Decora Digital	DDE06
Lutron	Diva	DVELV-300P-WH
	Skylark	SELV-300P-WH

0-10V DIMMING

Manufacturer	Product	Model
Leviton	IllumaTech	IP710-DLX, IP710-LFZ
Lutron	Diva	DVSCSTV, DVSCSTV, DVSTV, DDTV, DDTV-WH

- Testing has been performed on these Dimmers, but this does not imply any warranty of compatibility
- Dimming performance can be influenced by different Loads, as well as variations in Dimmer Switches within the same Model
- Dimmer Maximum Load Rating with LED may differ from published Traditional Source Dimmer Ratings; consult manufacturer for maximum dimmer information
- Consult factory for additional dimming information

MAX RUN LENGTH

INPUT = 24VDC

LED Driver	AFSS48-7H
Wattage	Max Run Length
20W	2 FT
36W	4 FT
60W	8 FT
96W	16 FT

- Max Run refers to the total single run of Strip Light that can go on a Driver
- Max Run Lengths are calculated with 24V DC at the start of the Strip Light run. Voltage drop may occur if not using proper wire gauge. Refer to the Voltage Drop and Wire Length Distance chart.
- Max Run lengths above are calculated with no more than 30% light loss from the start of the Strip Light run to the end of the Strip Light run for optimal light consistency. If run lengths are extended beyond the recommended lengths noted above, there will be inconsistent light output and voltage drop.
- Overall distance of Strip Light under load (lit length). If exceeded, damage to the Driver and Strip Light may result.

VOLTAGE DROP AND WIRE LENGTH DISTANCE

3% VOLTAGE DROP

Wire Gauge	20W	30W	36W	60W	96W
22 AWG	27 FT	18 FT	15 FT	9 FT	5 FT
20 AWG	43 FT	28 FT	24 FT	14 FT	9 FT
18 AWG	68 FT	45 FT	38 FT	23 FT	14 FT
16 AWG	109 FT	72 FT	60 FT	36 FT	23 FT
14 AWG	174 FT	115 FT	95 FT	57 FT	36 FT
12 AWG	272 FT	181 FT	151 FT	90 FT	57 FT
10 AWG	432 FT	288 FT	240 FT	144 FT	90 FT

The Voltage Drop/Wire Length Distance Chart provides general guidelines for determining wire gauge based on total load and distance from the Driver to the beginning of the Strip Light run.